

12.8cm Sf. L/61 (Pz.Sf.V) "STURER EMIL"

128毫米61倍径自行反坦克炮“埃米尔”

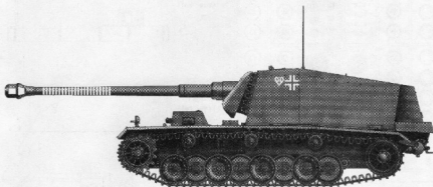

READ BEFORE ASSEMBLY

- Study and understand these instructions thoroughly before beginning assembly. Make sure all parts are included by comparing them to those shown on pages 2 & 3 of these instructions.
- Remove parts from sprues as needed, and trim excess with a hobby knife. Be careful not to lose small parts.
- Remove photo-etch parts from sprue as needed using a hobby knife or photo etch cutter.
- Apply cement to photo etch parts as shown on instructions. Applying too much cement will restrict the operation of these movable parts. Apply cement carefully! Removed photo etch parts can have sharp edges. Take care when handling these to avoid injury.
- Apply decals to necessary parts prior to assembly.
- Additional tools recommended(not included):Sprue cutter, Long nose pliers, hobby knife, file, tweezers, pin vise, scissors, cement, sandpaper, soft cloth, glue and paint.
- Keep all parts out of reach of children, as they pose a choking hazard. Discard all unnecessary bags and sprues when model is completed to avoid accidental injury.

装配之前仔细阅读

- 小心用模型锋刀锉平所有零件表面的注射浇口。
- 小心用刀片切下蚀刻片零件，不要遗失小零件。
- 用强力快干胶水粘合蚀刻片零件和金属插。过量的快干胶水使用可能导致可动零件会粘住，小心涂胶。
- 取蚀刻片时应特别注意安全，防止利刃划伤手指。
- 某些零件表面需贴水上贴纸，请选择在装配的同时进行。
- 推荐模型工具(自备)：胶水，水口剪刀，长咀钳，刀片，锉刀，镊子钳，钻，剪刀，瞬间快干胶。
- 软布同砂纸同时也应该是必备工具。
- 请使用塑料胶水和油漆，模型内不含。
- 谨防小童吸吮塑料零件，或者将塑料袋套在头上，制作时应将套材远离小孩接触。



cyanacrylate glue
使用强力胶



weight
配重



make hole
钻孔



cut / remove
切除



bend
弯曲



file / sand
锉平



option
选择



no cement
不涂胶水



decal
贴纸

水贴纸的使用:

1. 从水贴上剪下印花;
2. 将印花放入温水中浸10秒, 然后放在干净布上;
3. 拿着印花纸板将印花移到模型上;
4. 手指蘸水将印花移到适当的位置;
5. 用软布轻压印花直至水干, 气泡消失。

DECAL APPLICATION

1. Cut off decal from sheet.
2. Dip the decal in tepid water 40°C for about 10 sec, and place on a clean cloth.
3. Hold the backing sheet edge and slide decal onto the model.
4. Move decal into position by wetting decal with finger.
5. Press decal gently down with a soft cloth until excess water and air bubbles are gone.

部品图

Part

A x 2

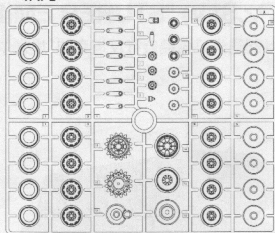

《车面》
Upper hull

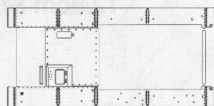

《车底》
Lower hull

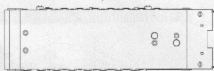

B

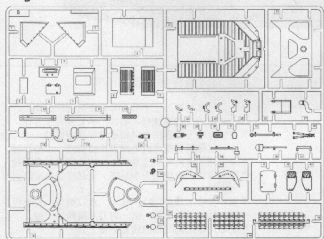

《炮塔》
Turret

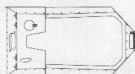

E

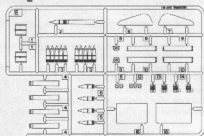

D

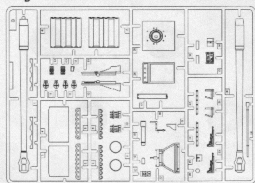

C

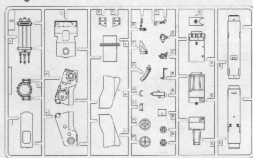

《履带》 x 2

Track

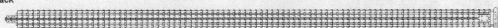

《水贴纸》
Decal

1 悬挂组装
Suspension assembly

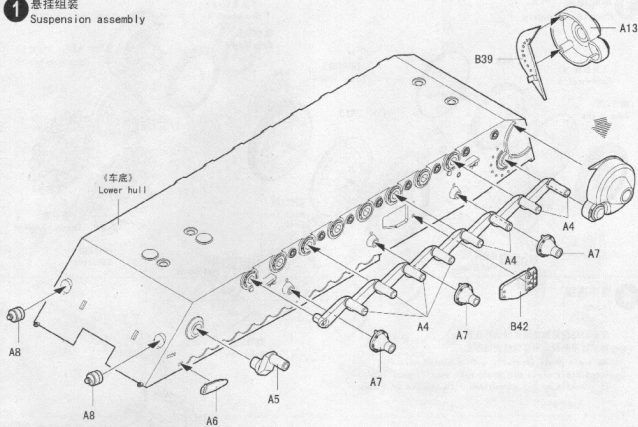

2 悬挂组装
Suspension assembly

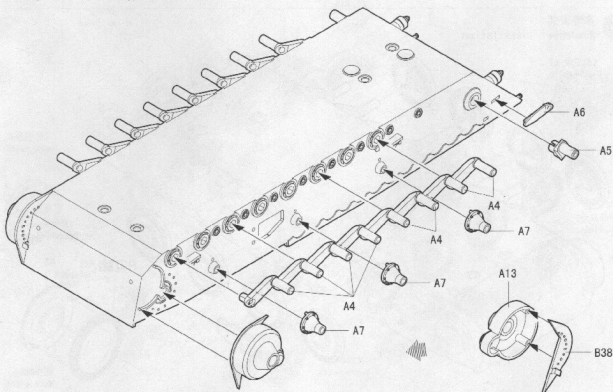

3 车轮组装 Wheels assembly

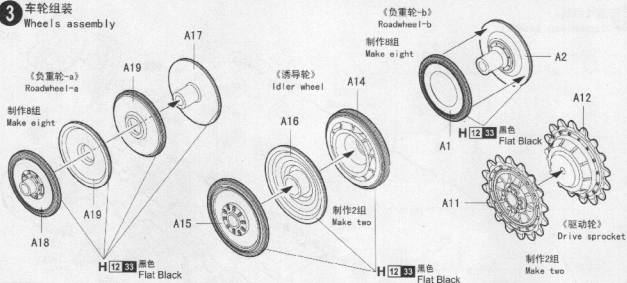

4 履带连接 Track

定位好履带后加热软化接头并压紧：
如果履带断裂，用细钢丝连接固定。
Melt pin heads with a heated nail etc.
Immediately press pin heads with your finger;
If track is broken strengthen with staples or thread.

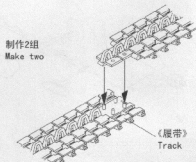

5 车轮安装 Roadwheel installation

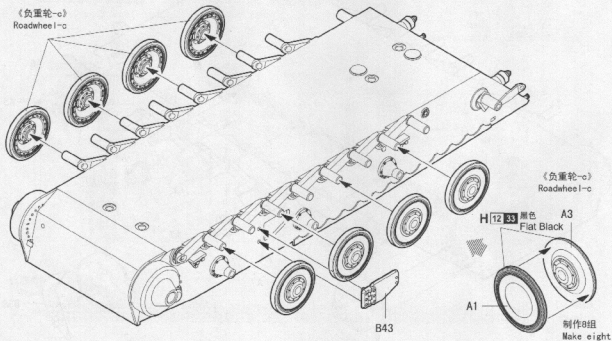

6 车轮安装
Roadwheel installation

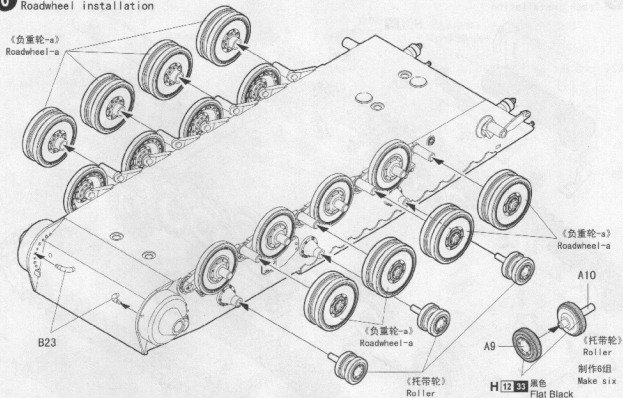

7 车轮安装
Roadwheel installation

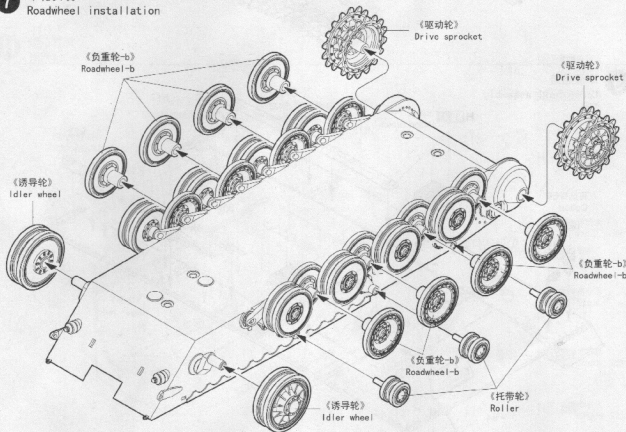

8 履带安装 Track installation

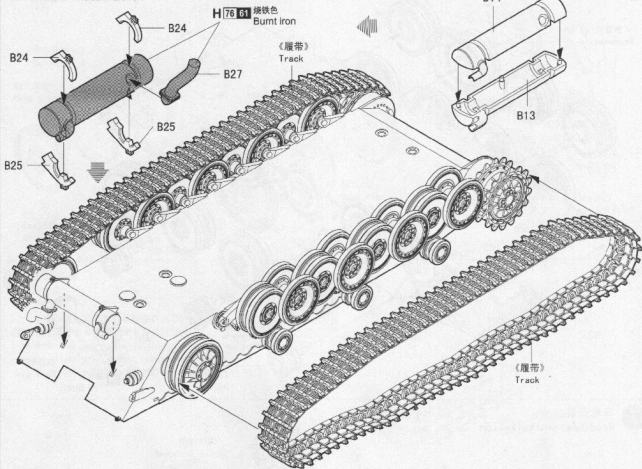

9 车面组装 Upper hull assembly

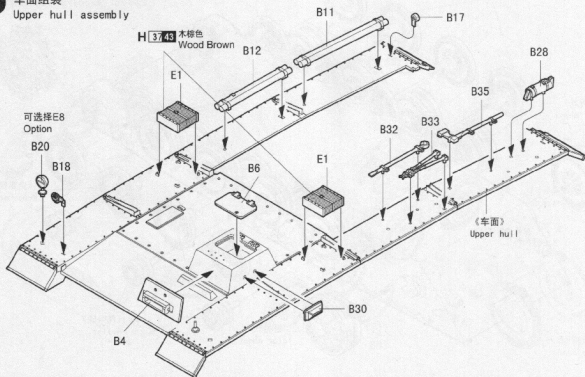

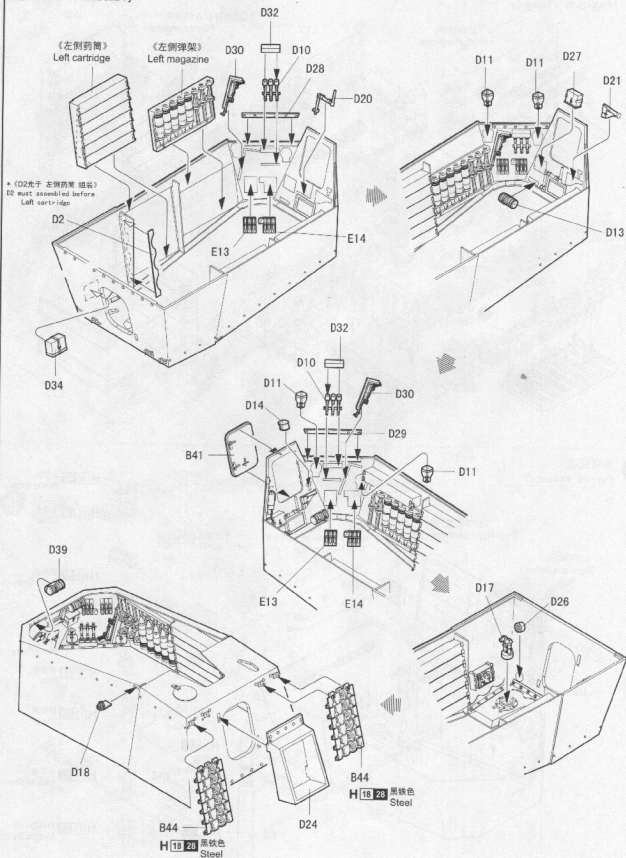

13 炮尾组装
Breach assembly

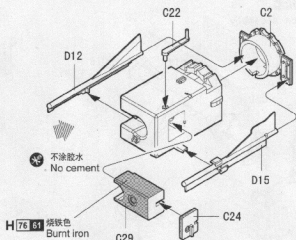
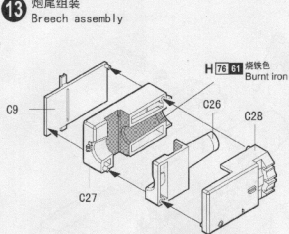

14 火炮组装
Cannon assembly

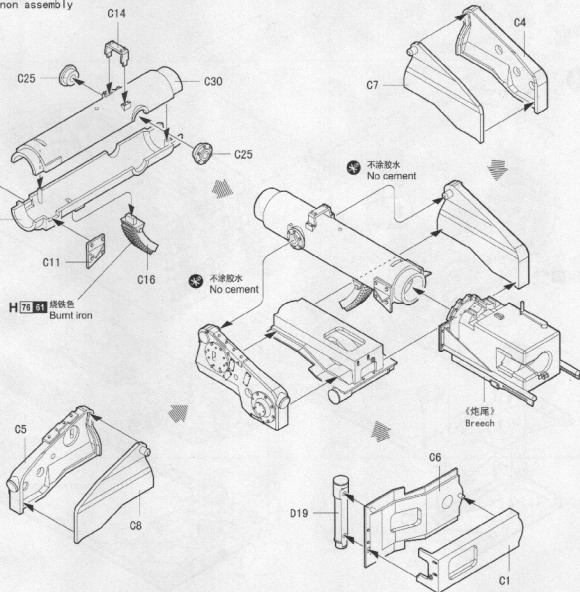
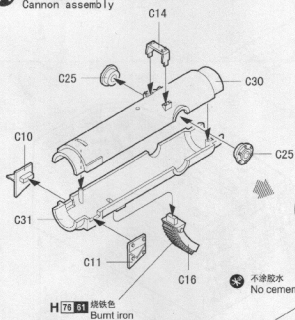

15 火炮组装
Cannon assembly

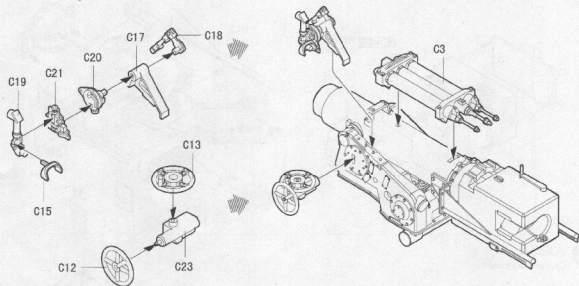

16 炮塔组装
Turret assembly

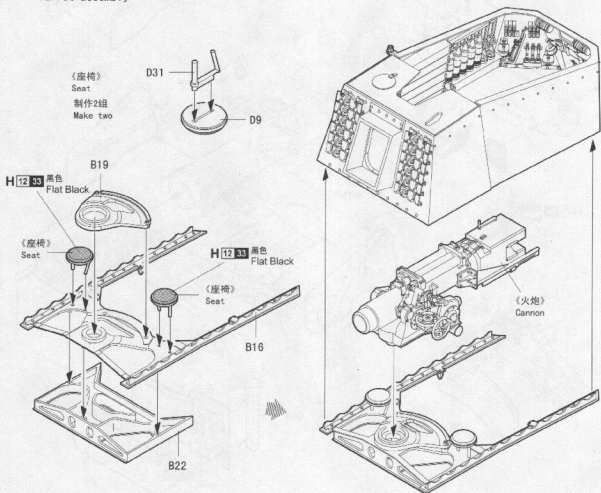

17 车面安装
Upper hull installation

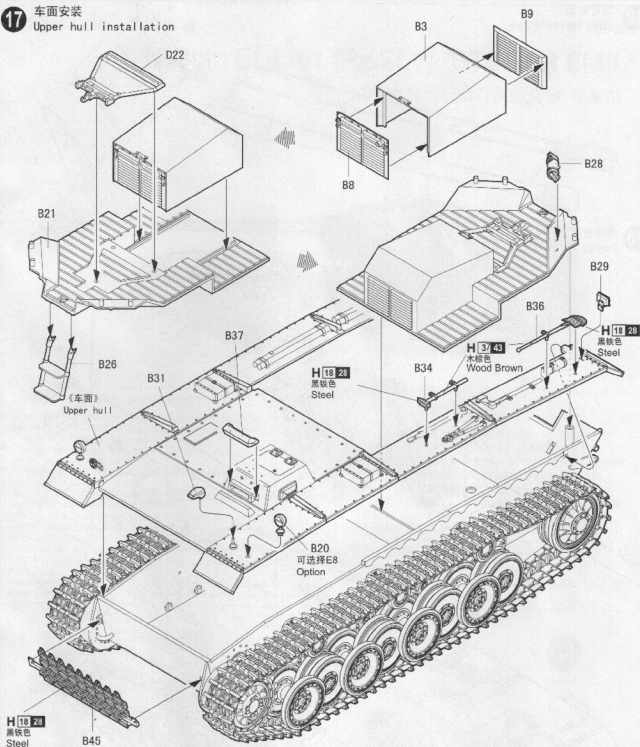

18 天线制作
How to make antenna

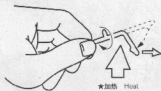

★加热烫口，拉线冷却。冷却后截成所需长度。
Heat sprue as shown, remove from flame and stretch allow to cool and cut to required length.

19 炮管安装
Tube installation

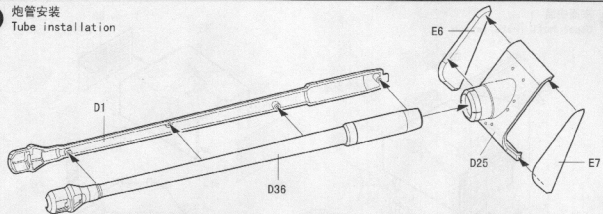

20 炮塔安装
Turret installation

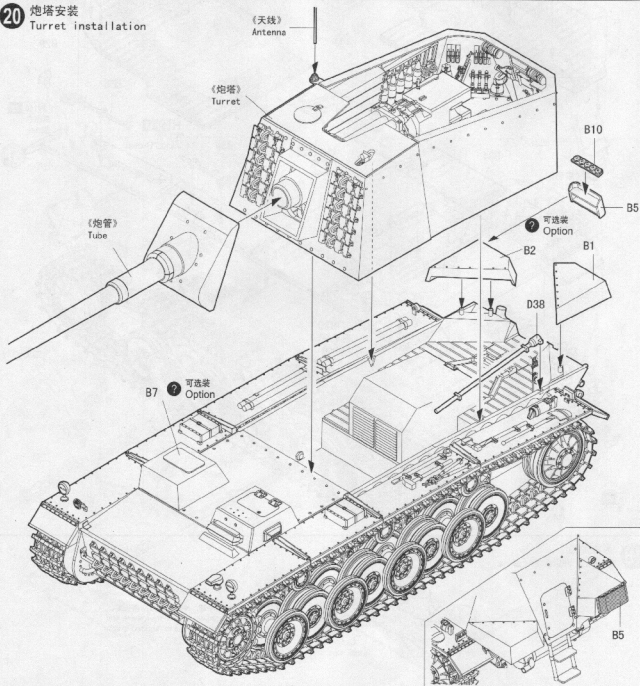

涂装同标贴指示
Painting & Marking guide

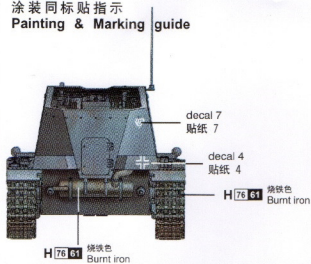

郡仕色使用
Gunze Mr. color used

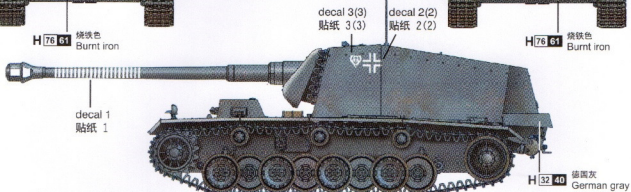
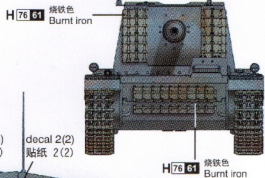

The 3rd Company 521st schwere Panzerjäger Abteilung.

涂装同标贴指示
Painting & Marking guide

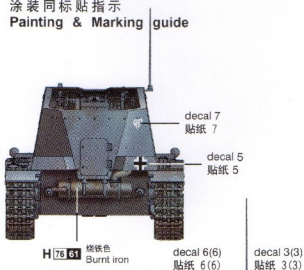

郡仕色使用
Gunze Mr. color used

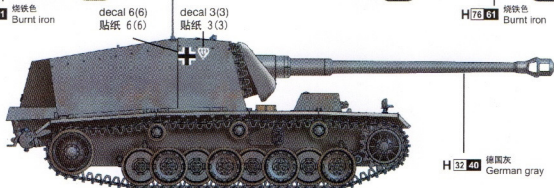
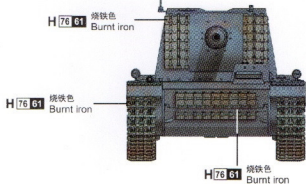

The 3rd Company 521st schwere Panzerjäger Abteilung.