

HMS HOOD

1:350 Scale

英国皇家海军胡德号战列巡洋舰

READ BEFORE ASSEMBLY

- Study and understand these instructions thoroughly before beginning assembly. Make sure all parts are included by comparing them to those shown on pages 2 & 3 of these instructions.
- Remove parts from sprues as needed, and trim excess with a hobby knife. Be careful not to lose small parts.
- Remove photo-etch parts from sprue as needed using a hobby knife or photo etch cutter.
- Apply cement to photo etch parts as shown on instructions. Applying too much cement will restrict the operation of these

movable parts. Apply cement carefully! Removed photo etch parts can have sharp edges. Take care when handling these to avoid injury.

- Apply decals to necessary parts prior to assembly.
- Additional tools recommended(not included):Sprue cutter, Long nose pliers, hobby knife, file, tweezers, pin vise, scissors, cement, sandpaper, soft cloth, glue and paint.
- Keep all parts out of reach of children, as they pose a choking hazard. Discard all unnecessary bags and sprues when model is completed to avoid accidental injury.

装配之前仔细阅读

- 小心用模型锉刀锉平所有零件表面的注射浇口。
- 小心用刀片切下蚀刻片零件，不要遗失小零件。
- 用强力快干胶水粘合蚀刻片零件和金属轴。过量的快干胶水使用可能导致可动零件会粘住，小心涂胶。
- 取蚀刻片时应特别注意安全，防止利边划伤手指。
- 某些零件表面需贴水上贴纸，请选择在装配的同时进行。
- 推荐模型工具(自备)：胶水，水口剪刀，长咀钳，刀片，锉刀，镊子钳，钻，剪刀，瞬间快干胶。
- 软布同砂纸同时也应该是必备工具。
- 请使用塑料胶水和油漆，模型内不含。
- 谨防小孩吸吮塑料零件，或者将塑料袋套在头上，制作时应将套材远离小孩接触。

水贴纸的使用:

1. 从水贴上剪下印花;
2. 将印花放入温水中浸10秒, 然后放在干净布上。
3. 拿着印花纸板将印花移到模型上;
4. 手指蘸水将印花移到适当的位置;
5. 用软布轻压印花直至水干, 气泡消失。

DECAL APPLICATION

1. Cut off decal from sheet.
2. Dip the decal in tepid water 40°C for about 10 sec. and place on a clean cloth.
3. Hold the backing sheet edge and slide decal onto the model.
4. Move decal into position by wetting decal with finger.
5. Press decal gently down with a soft cloth until excess water and air bubbles are gone.



cyanoacrylate glue
使用强力胶



weight
配重



make hole
钻孔



cut / remove
切除



option
选择



no cement
不涂胶水



decal
贴纸



bend
弯曲



file / sand
锉平

部品图

Parts

上船体
Upper hull

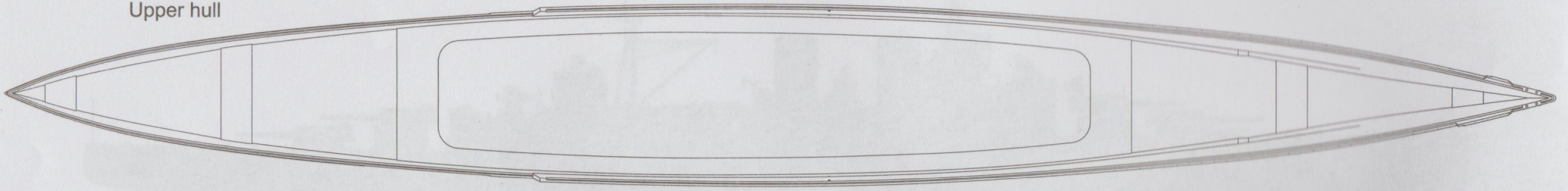

下船底
Lower hull

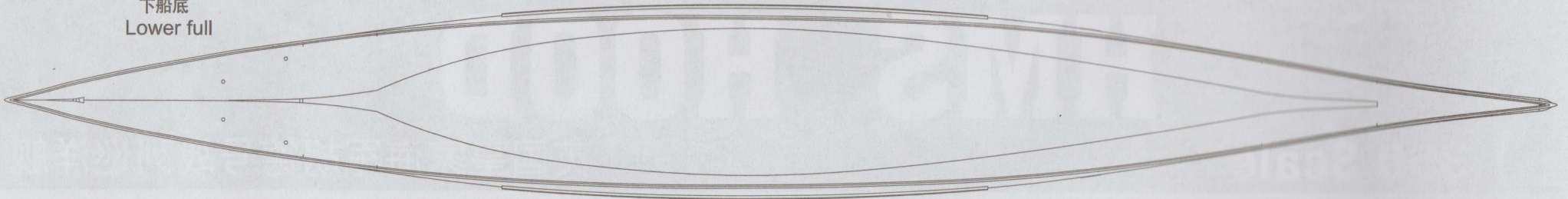

水线板
Waterline plate

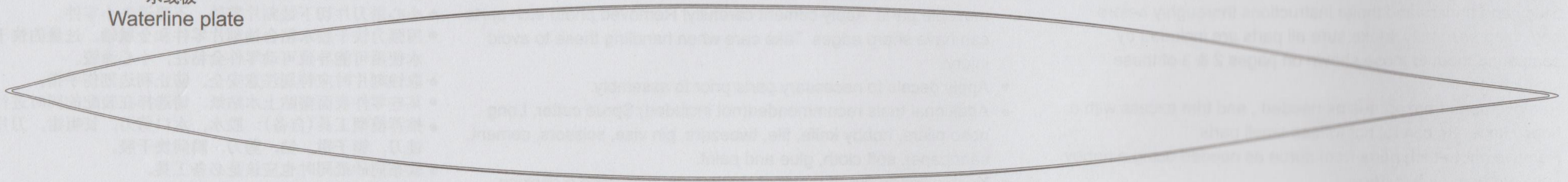

前甲板
Fore deck

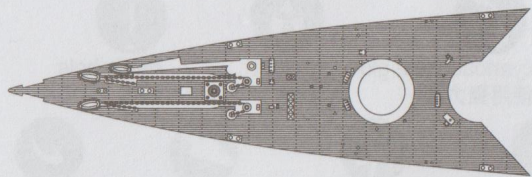

中甲板
Center deck

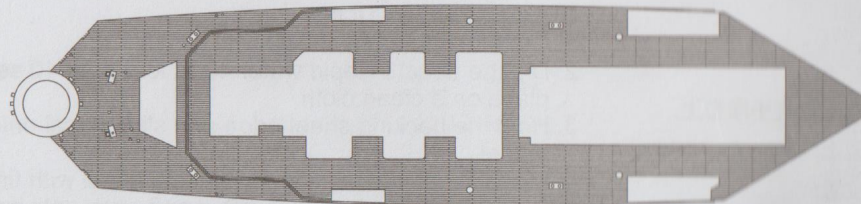

上层甲板
UP deck

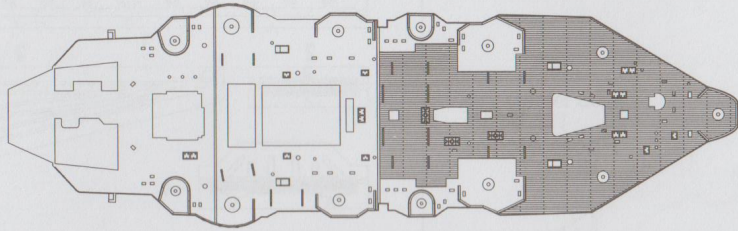

后甲板
Rear deck

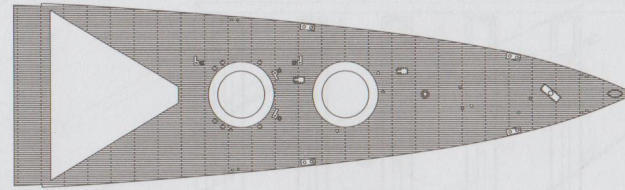

A

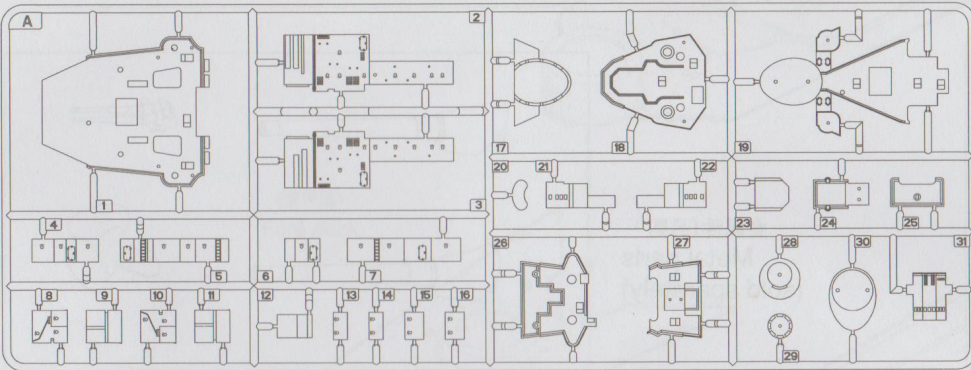

C

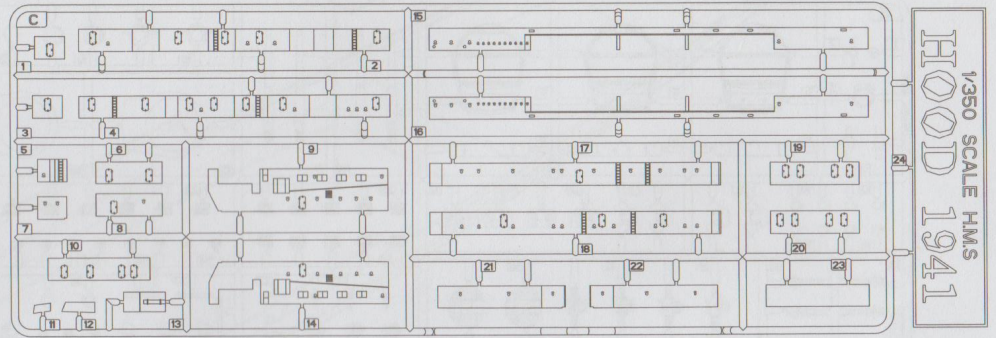

B

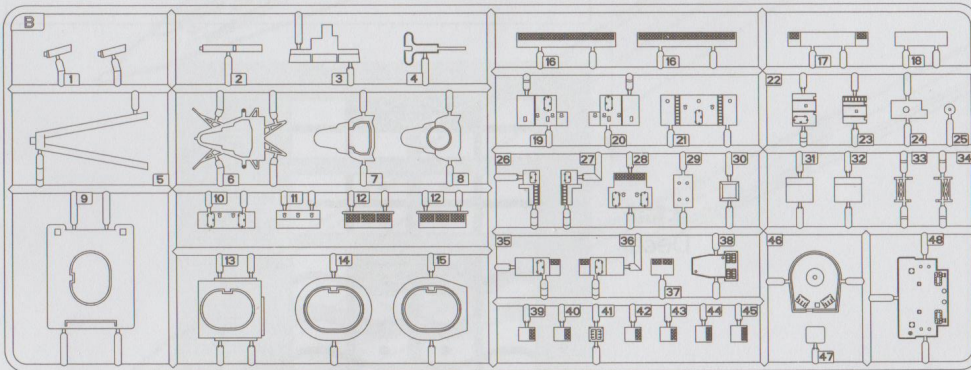

D

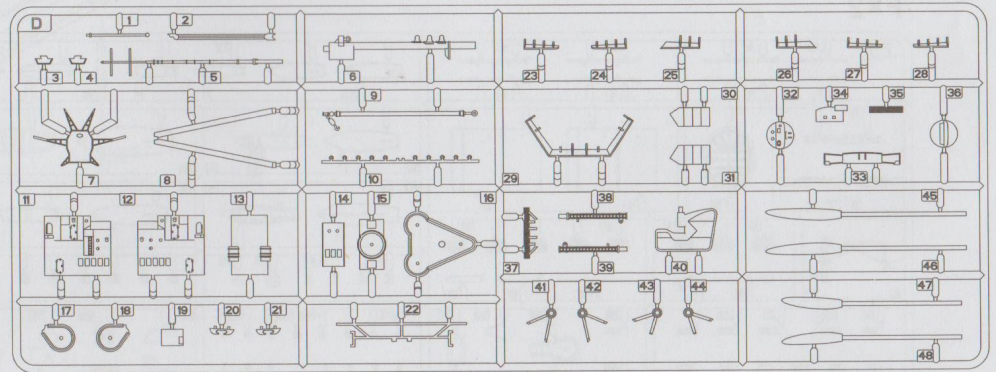

座架
Stand

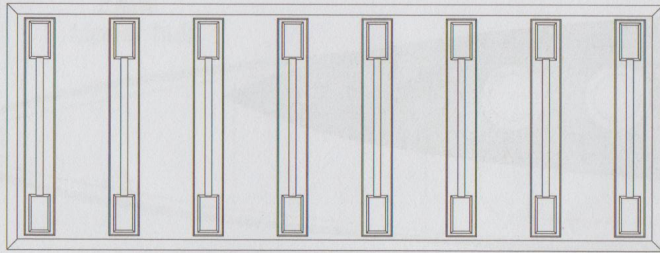

E×2

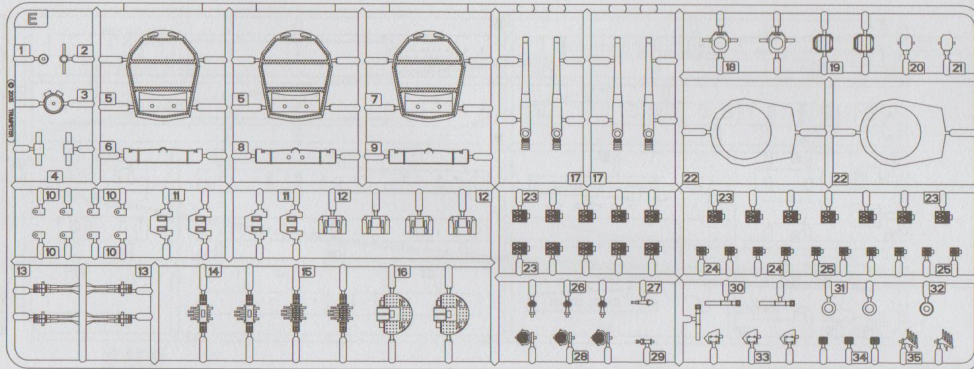

F×2

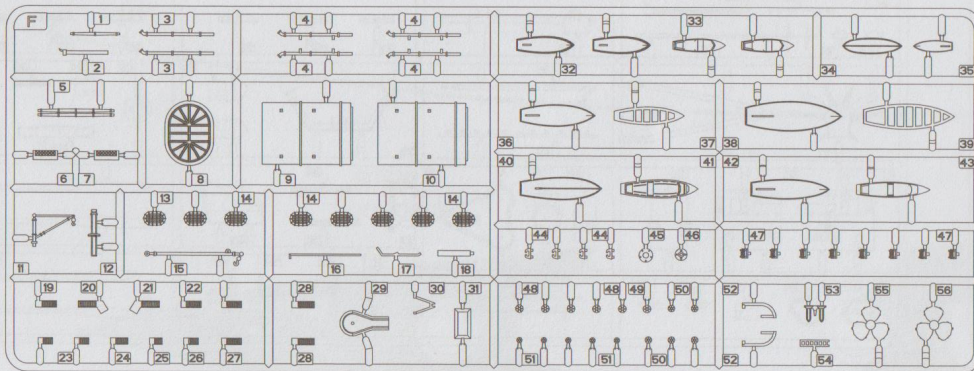

蚀刻片
Photo etched

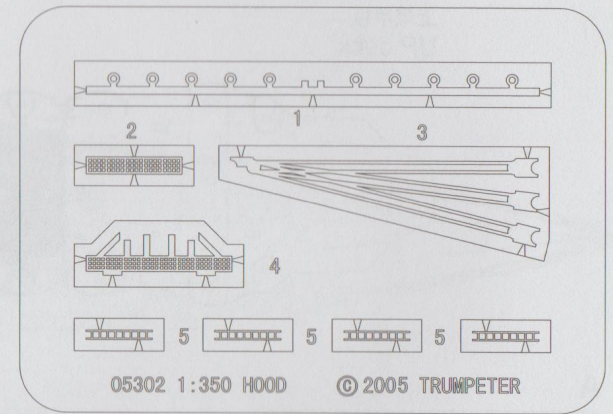

金属件(另购)
Metal parts
(sold separately)

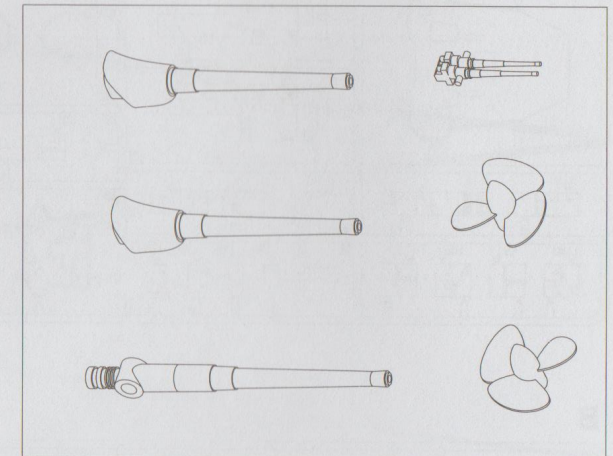

水贴纸
Decal

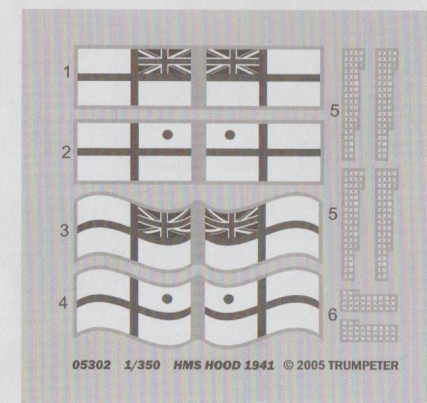

1

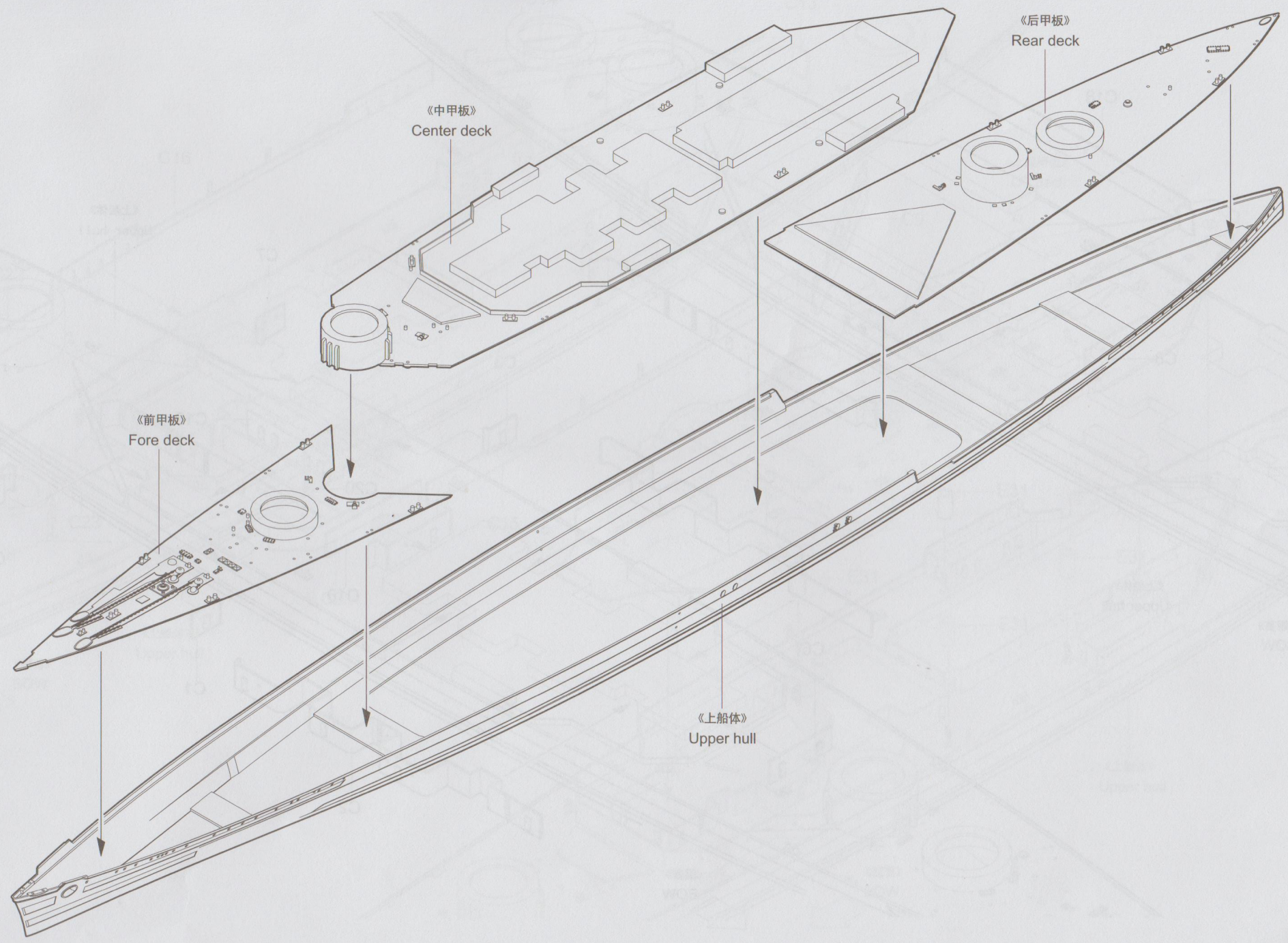

2

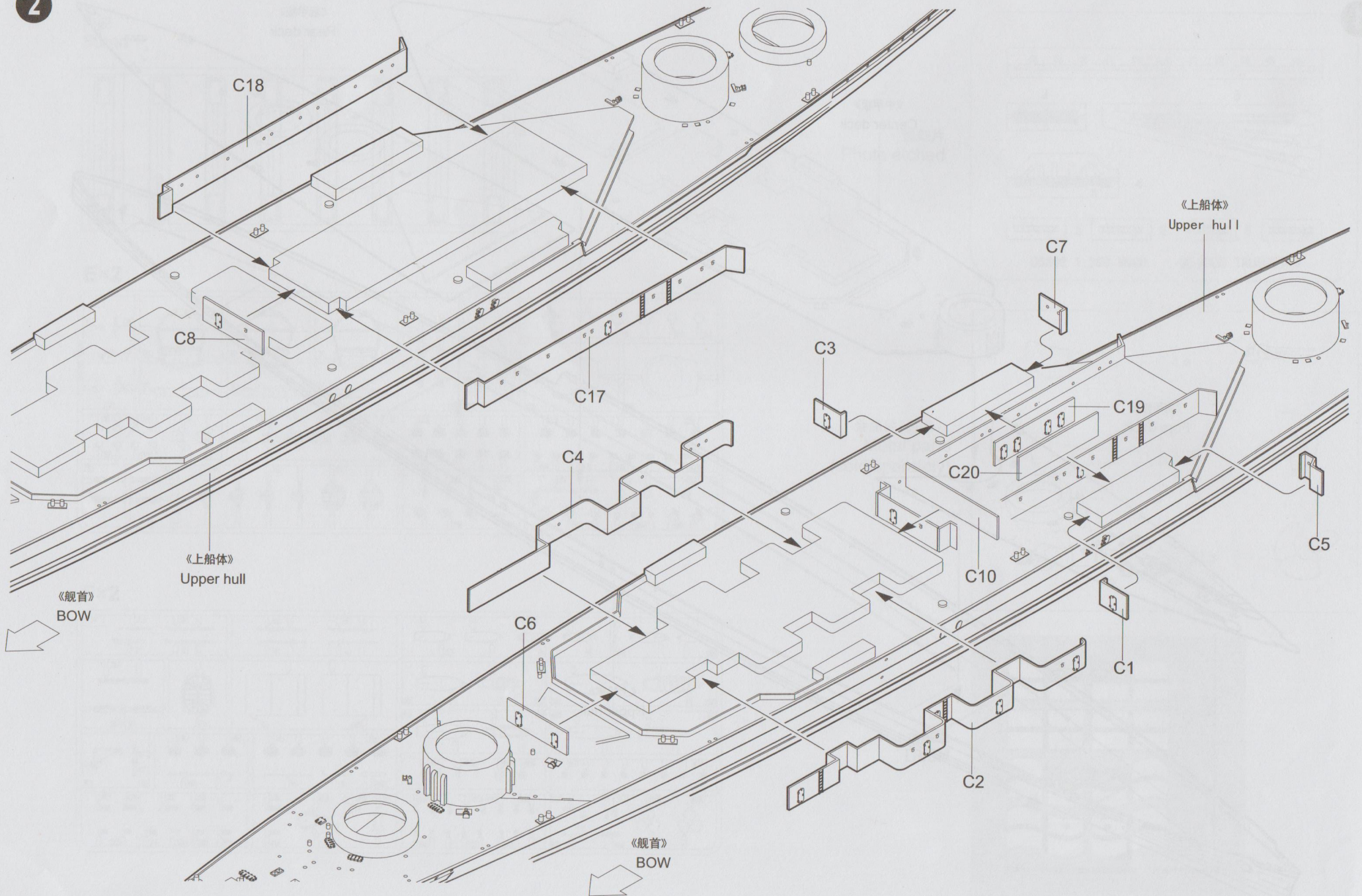

3

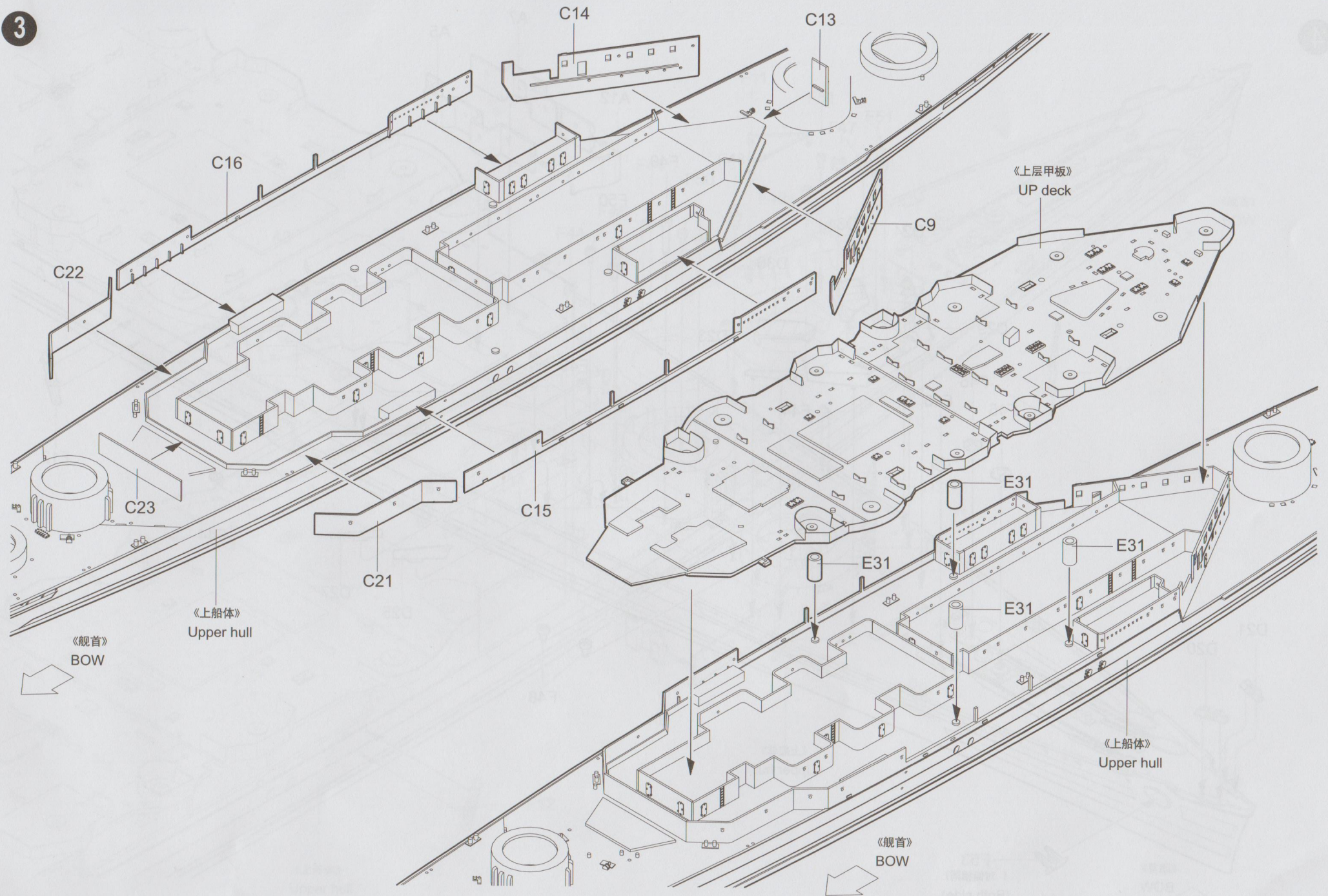

4

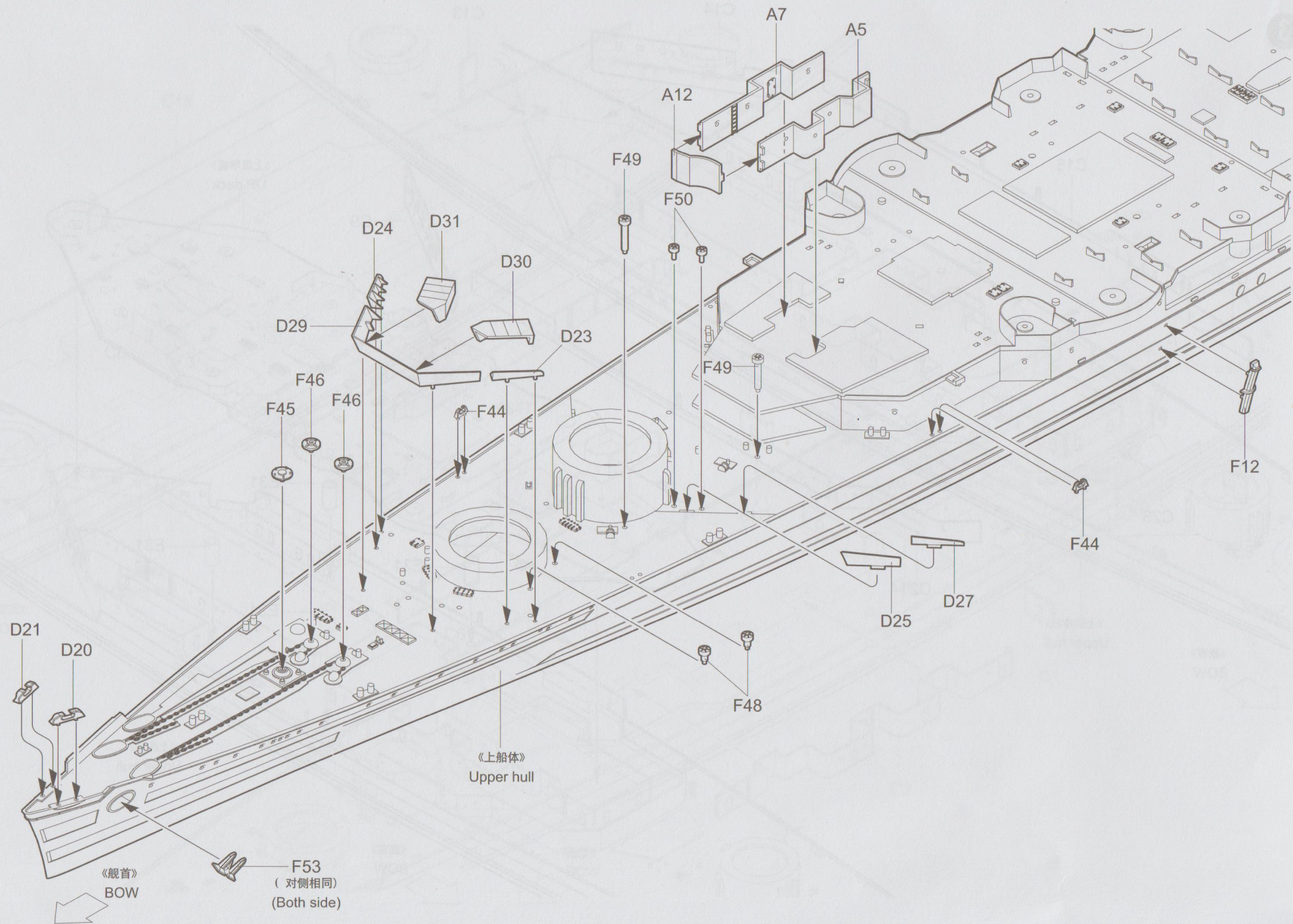

5

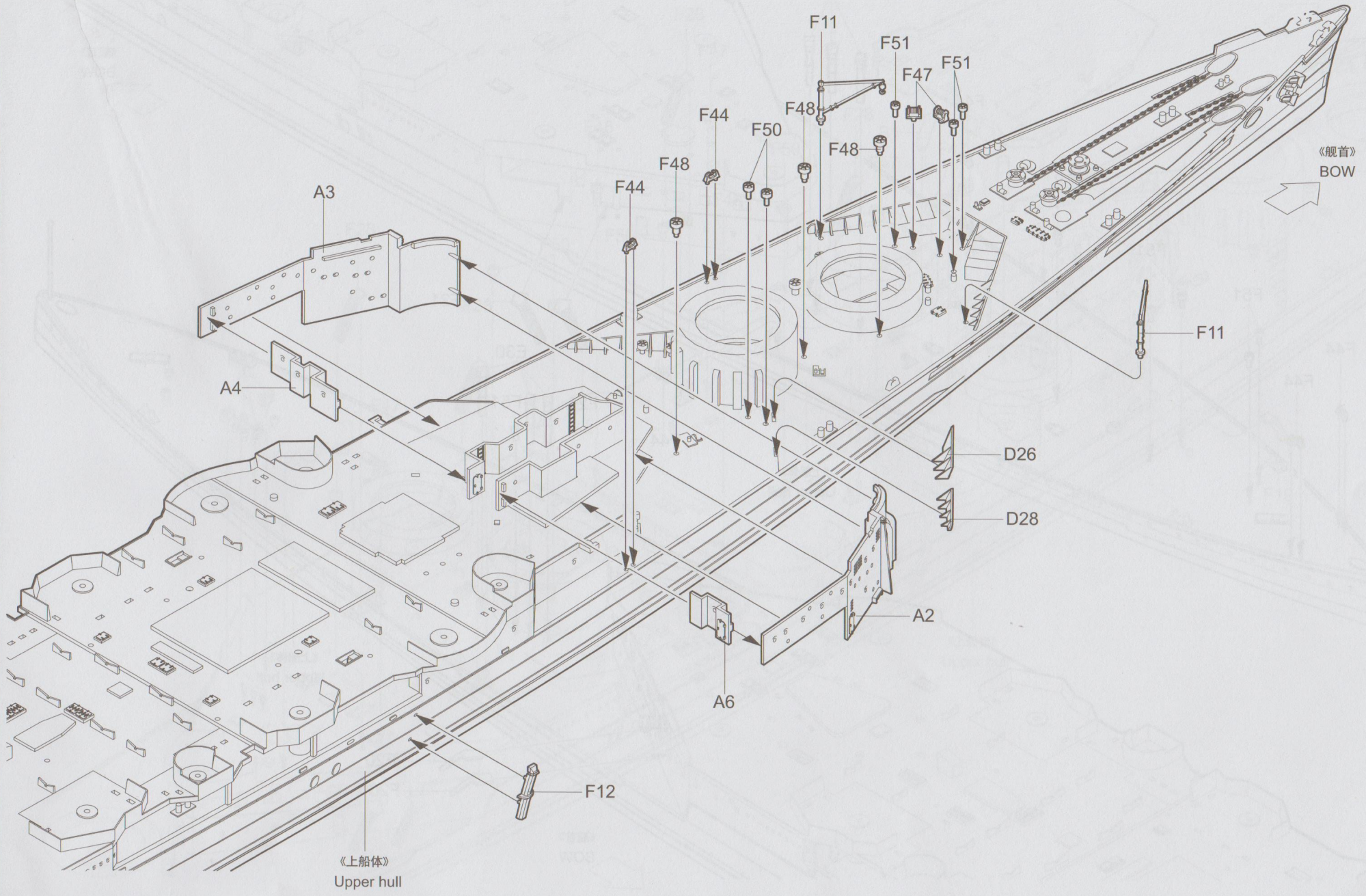

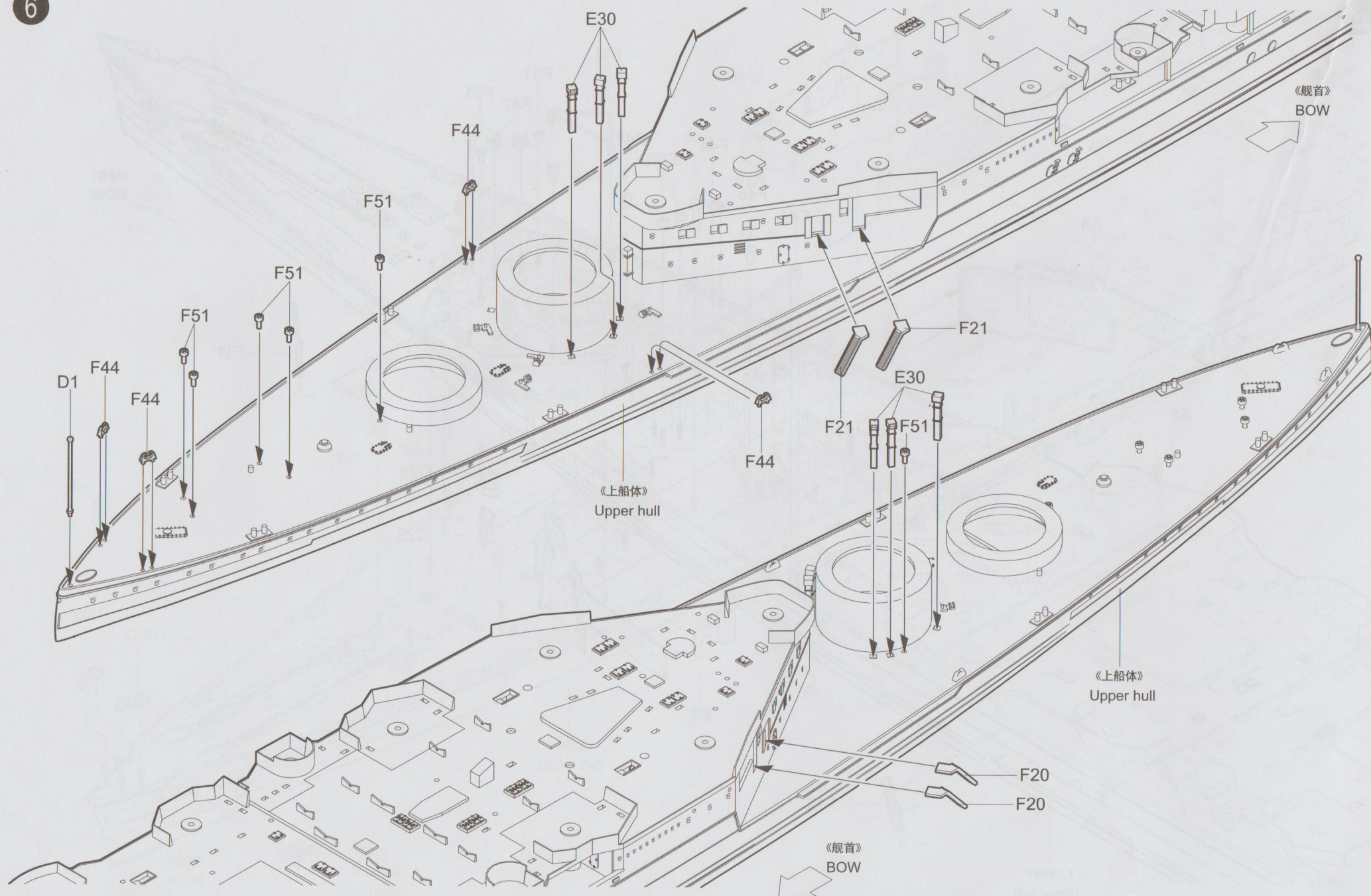

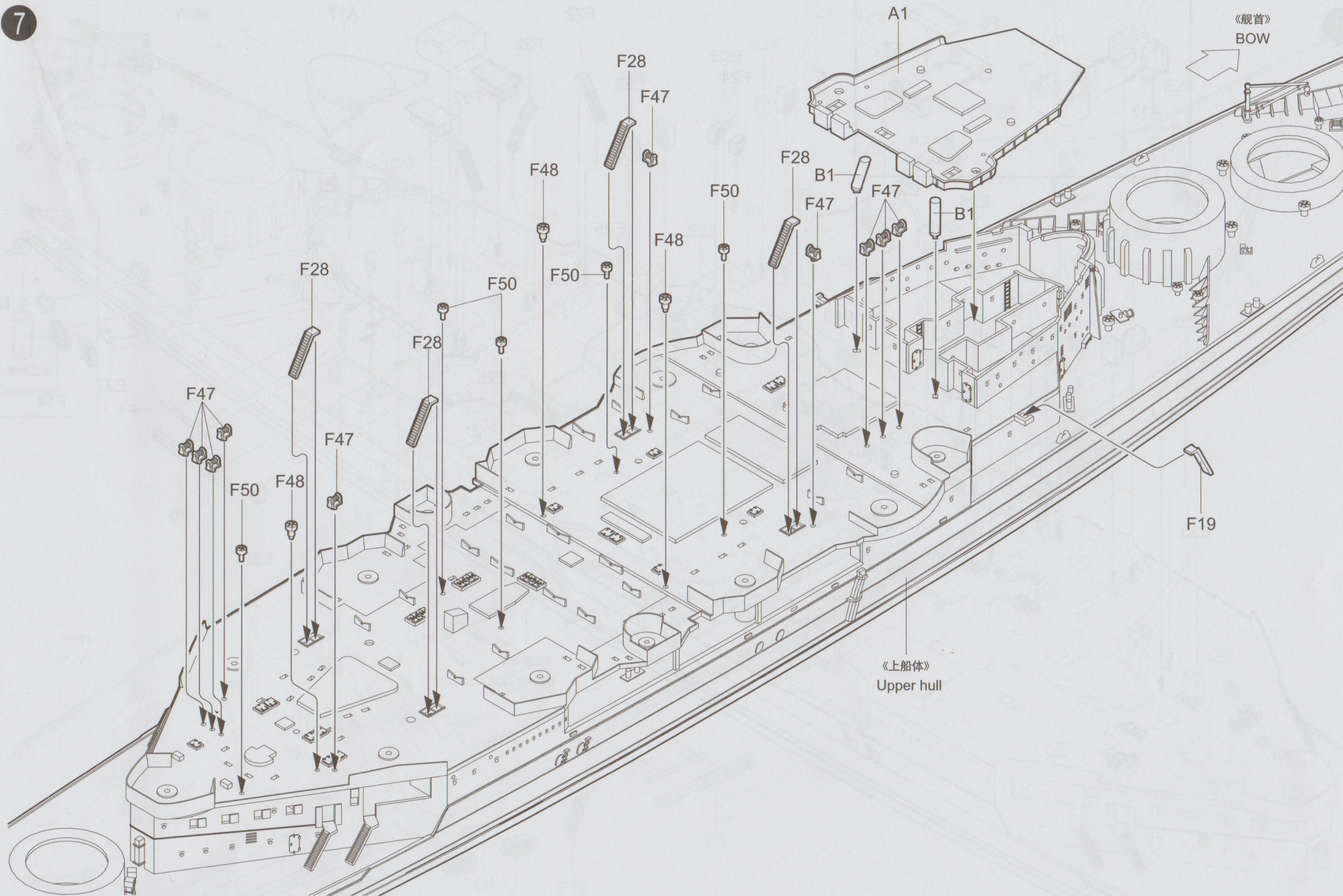

9

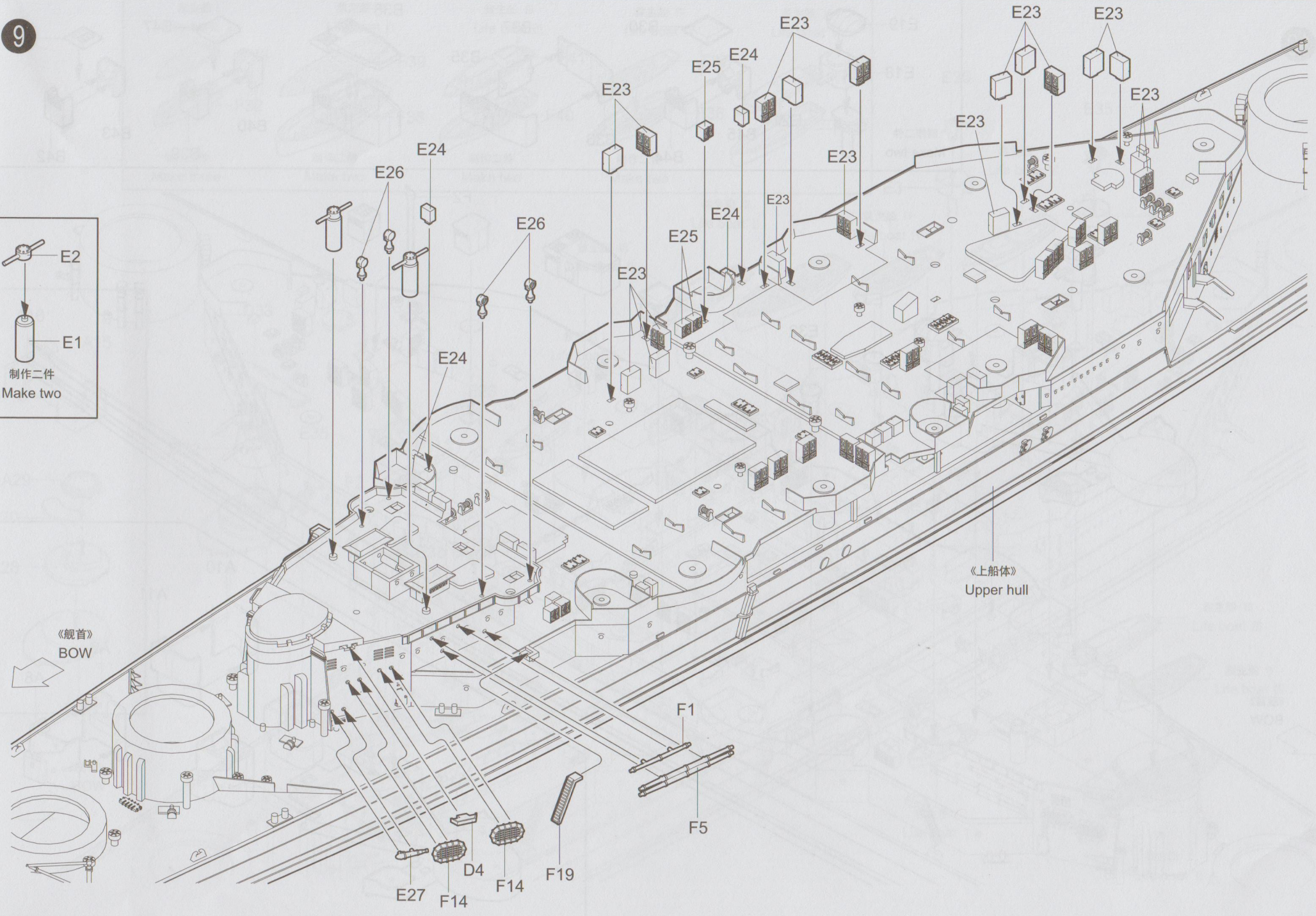
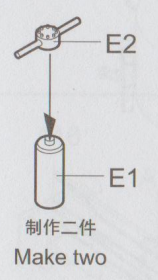

10

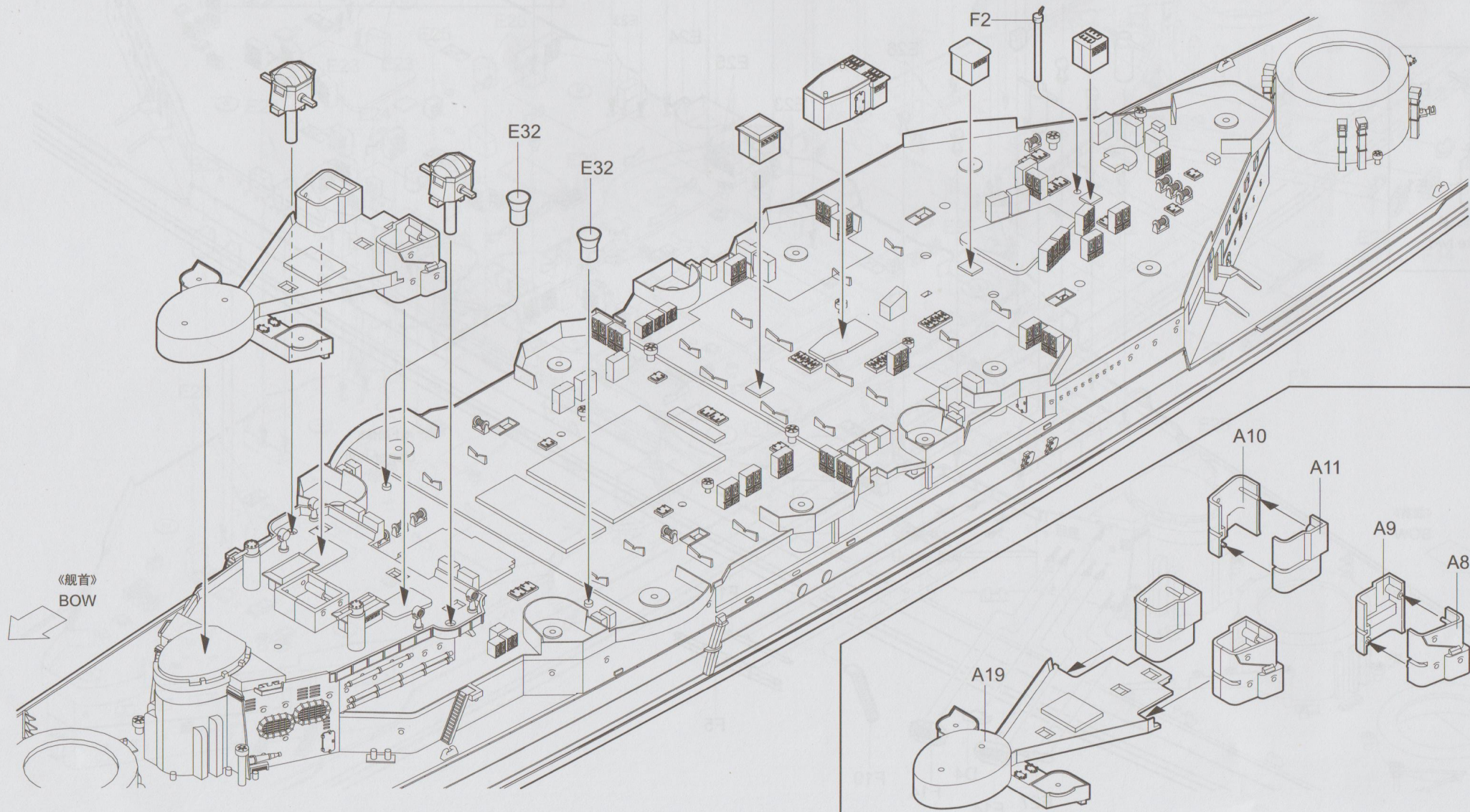
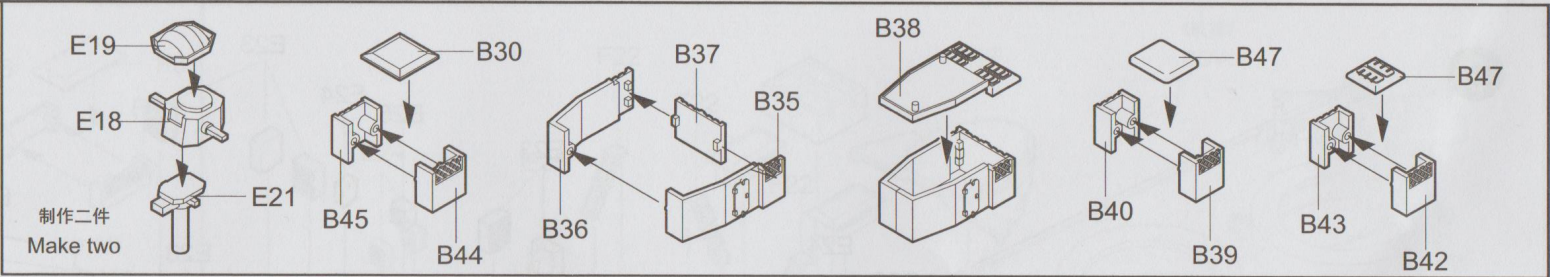

救生船 I
Life boat I

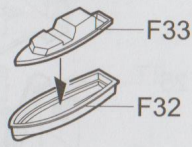

制作三件
Make three

救生船 II
Life boat II

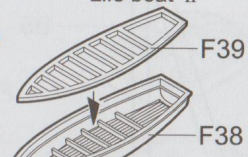

制作二件
Make two

救生船 III
Life boat III

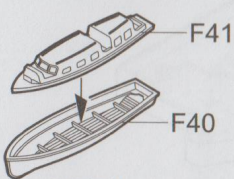

制作二件
Make two

救生船 IV
Life boat IV

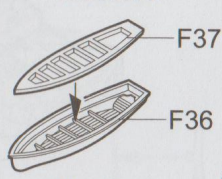

制作二件
Make two

救生船 V
Life boat V

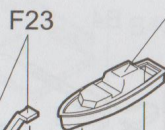
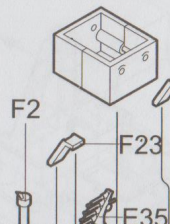
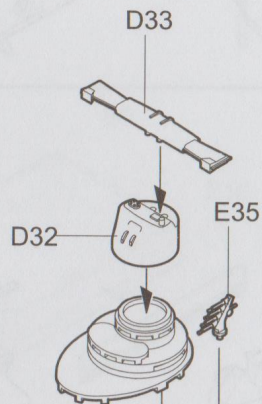
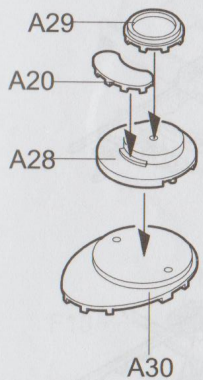
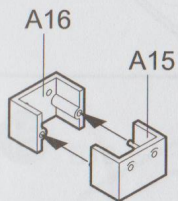
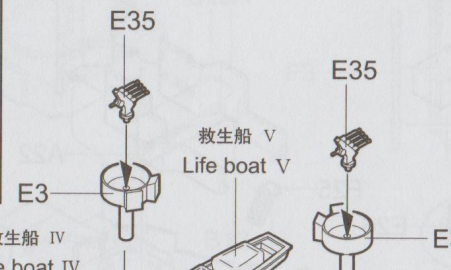
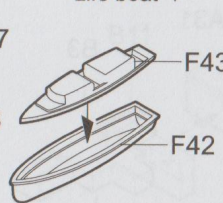

救生船 I
Life boat I

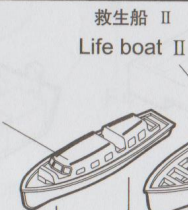

救生船 II
Life boat II

救生船 III
Life boat III



救生船 IV
Life boat IV

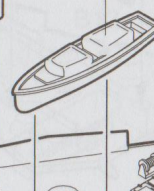

救生船 V
Life boat V

救生船 III
Life boat III

救生船 IV
Life boat IV

救生船 I
Life boat I

救生船 II
Life boat II

《舰首》
BOW

12

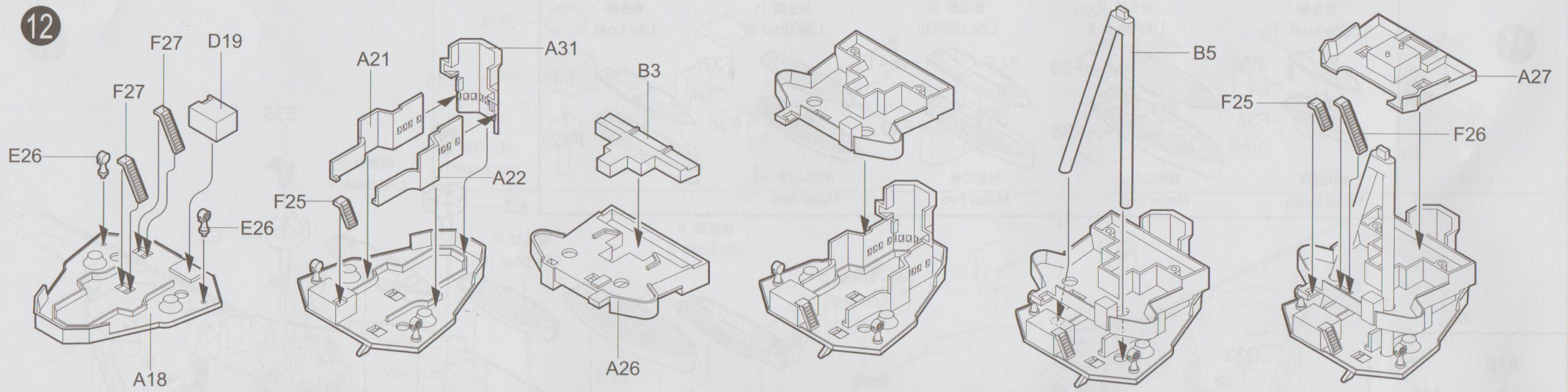

13

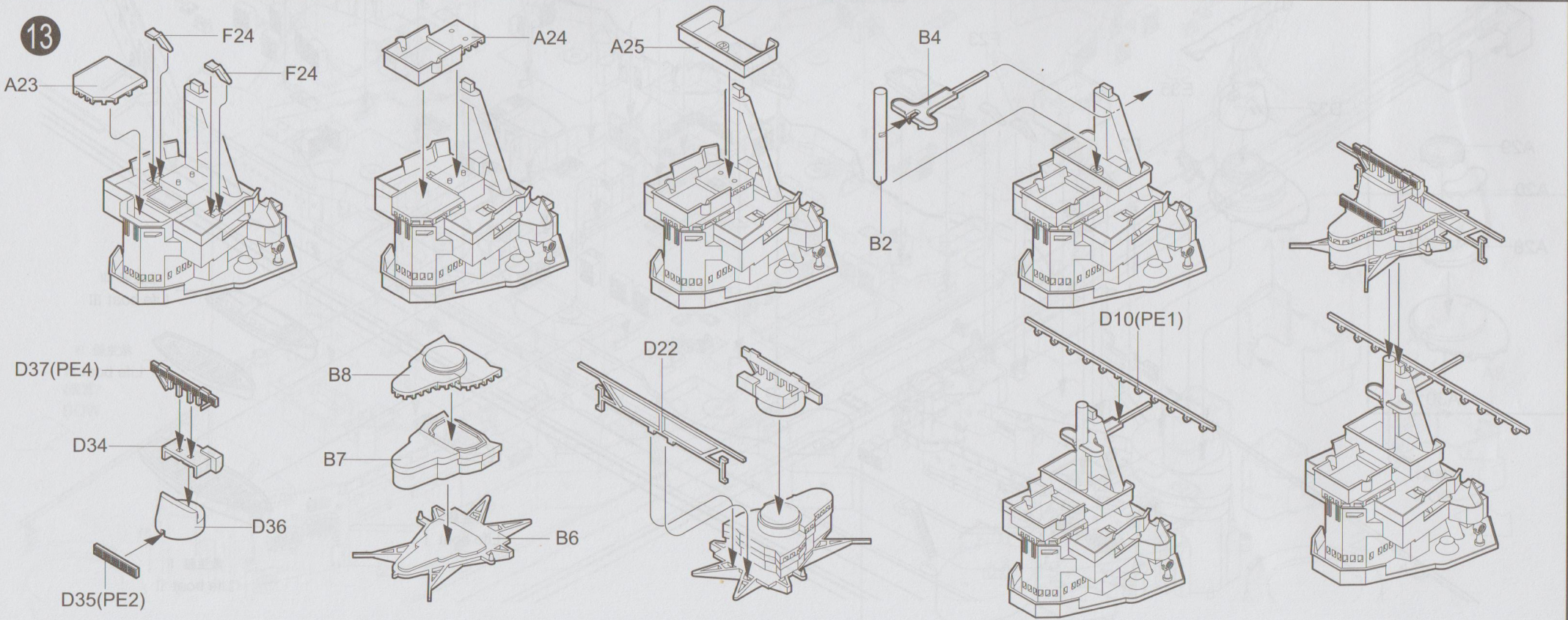

16

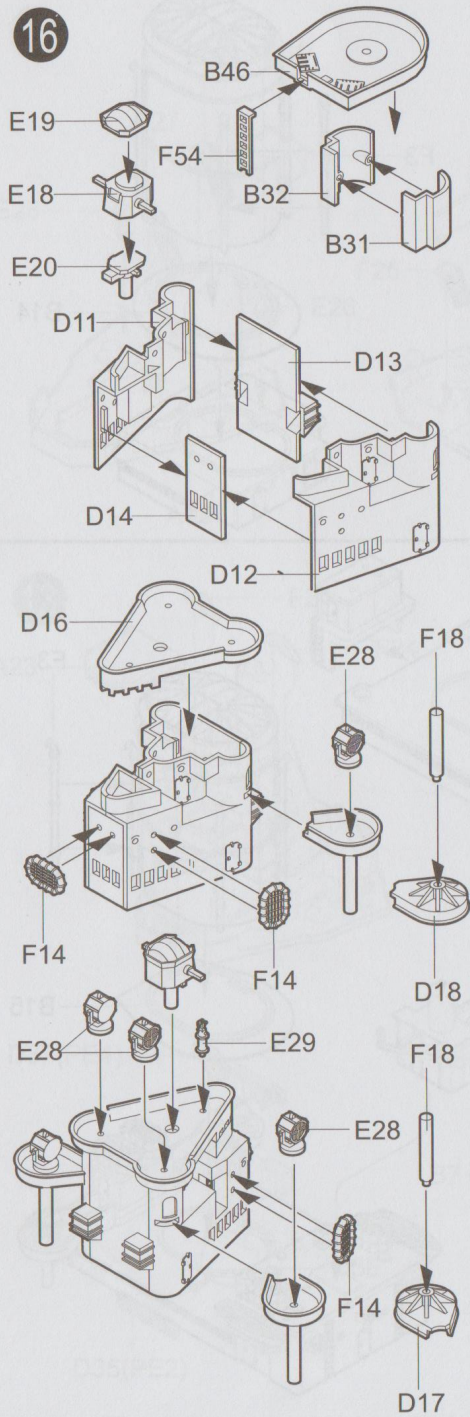

17

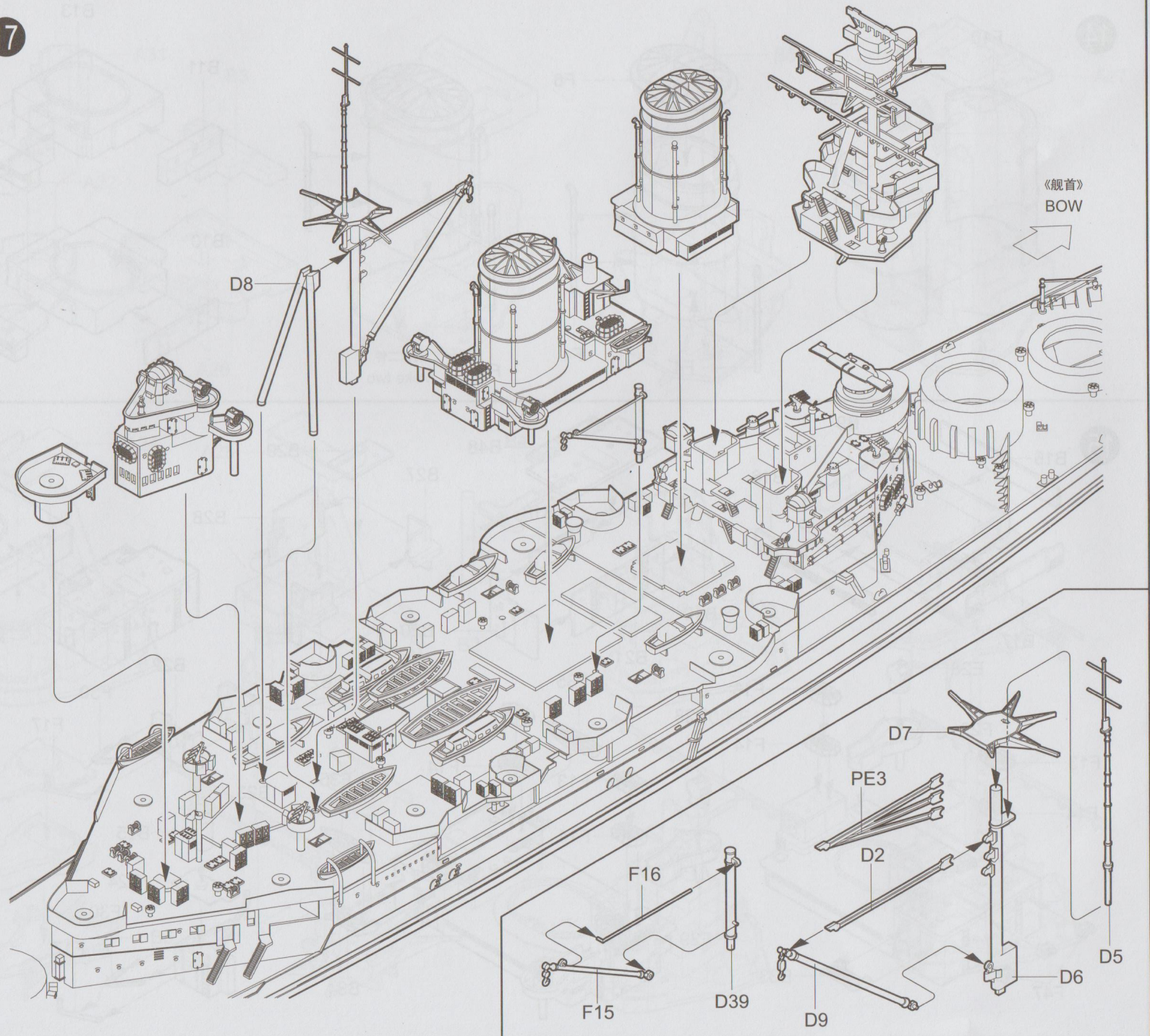

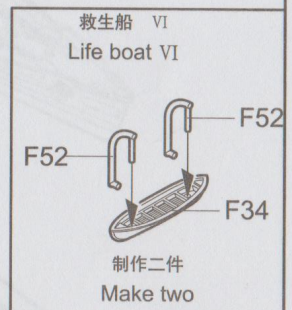
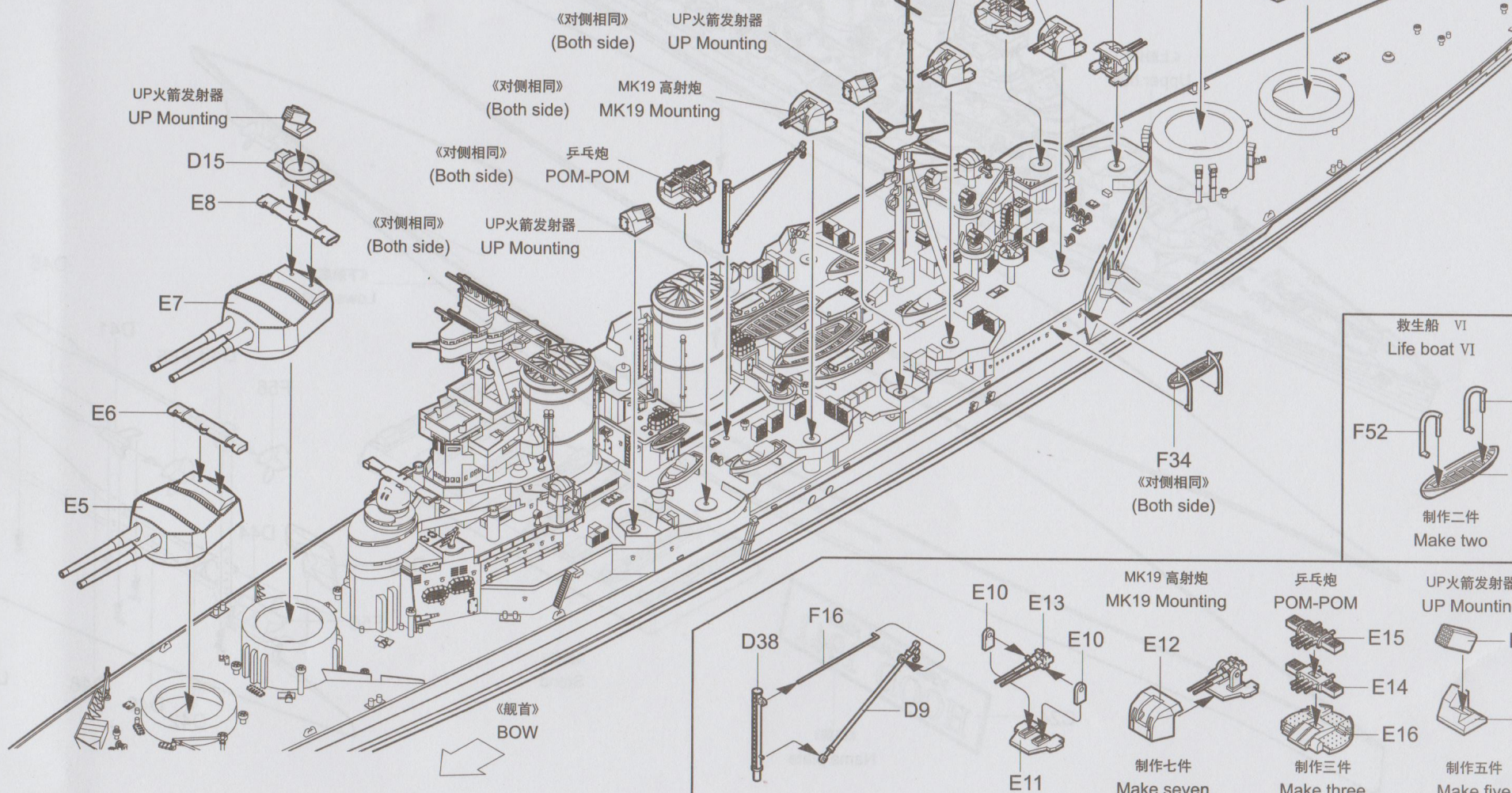
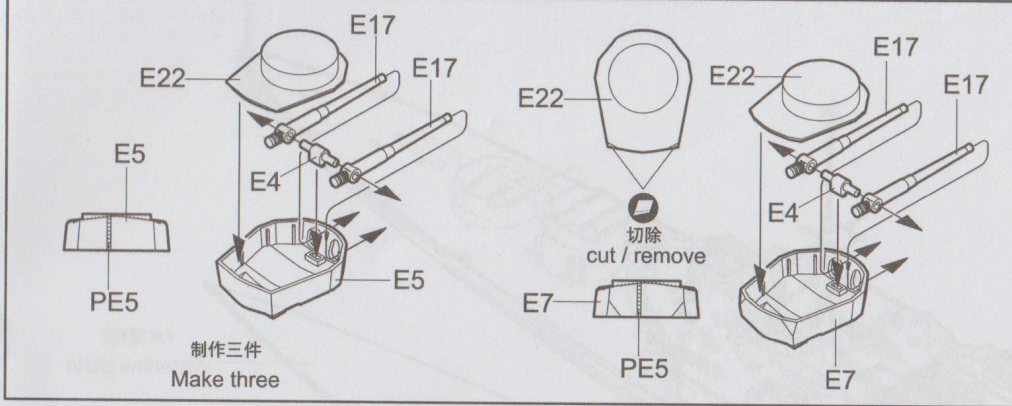

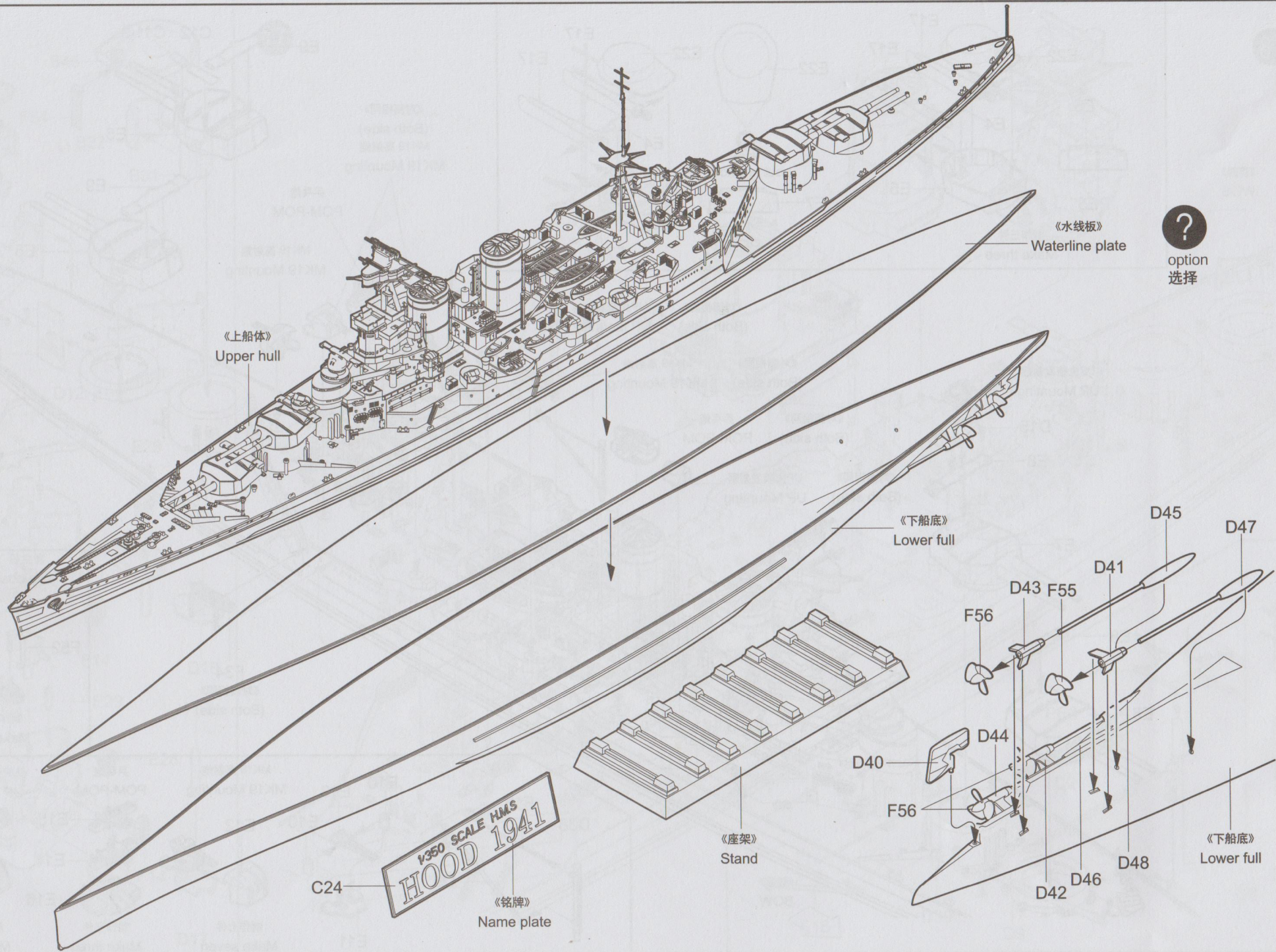

《上船体》
Upper hull

《水线板》
Waterline plate

option
选择

《下船底》
Lower full

《座架》
Stand

C24
1/350 SCALE HMS
HOOD 1941
《铭牌》
Name plate

D45
D47
D41
F56
D43
D40
D44
F56
D42
D46
D48
《下船底》
Lower full

