

1:72 SCALE

ITEM NO.:07227

Russia JS-3 Tank

苏联 "斯大林" - 3 坦克

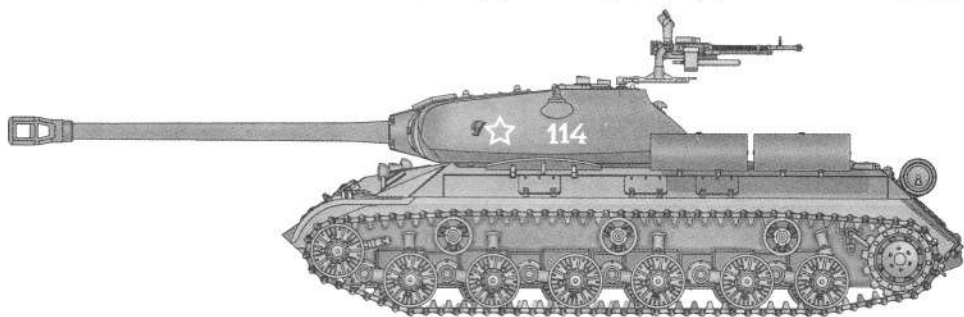

READ BEFORE ASSEMBLY:

- This kit is not recommended for inexperienced modelers or for children under 14 years of age
- Study and understand these instructions thoroughly before beginning assembly
- When needed, remove photo-etch parts carefully using a modeling knife or photo etch sprue cutter, being careful not to damage or lose small parts.
- Take extra care in handling photo etch parts in order to avoid injury
- Apply instant cement sparingly to photo etch parts where instructed
- Tools recommended(not included in kit):Plastic and instant cements,sprue cutters,long nose pliers, modeling knife, small files, tweezers, pin vise & scissors. Soft cloth and sandpaper will also assist in construction
- Glue and paint are not included in the kit. Use plastic cement and hobby paints only. Color guide for purchasing paint is included in the kit.
- Keep out of reach of small children. They must not be allowed to ingest small parts or handle plastic bags in any way.

装配之前仔细阅读

- 小心用模型锉刀锉平所有零件表面的注射浇口。
- 小心用刀片切下蚀刻片零件，不要遗失小零件。
- 用强力快干胶水粘合蚀刻片零件和金属轴。过量的快干胶水使用可能导致可动零件会粘住，小心涂胶。
- 取蚀刻片时应特别注意安全，防止利边划伤手指。
- 某些零件表面需贴水上贴纸，请选择在装配的同时进行。
- 推荐模型工具(自备)：胶水，水口剪刀，长咀钳，刀片，锉刀，镊子，钳，钻，剪刀，瞬间快干胶。
- 软布同砂纸同时也应该是必备工具。
- 请使用塑料胶水和油漆，模型内不含。
- 谨防小孩吸吮塑料零件，或者将塑料袋套在头上，制作时应将套材远离小孩接触。
- 本产品不适合14岁以下没有经验的模型爱好者。



cyanoacrylate glue
使用强力胶



weight
配重



make hole
钻孔



cut / remove
切除



bend
弯曲



file / sand
锉平



option
选择



no cement
不涂胶水



decal
贴纸

水贴纸的使用:

1. 从水贴上剪下印花;
2. 将印花放入温水中浸10秒，然后放在干净布上。
3. 拿着印花纸板将印花移到模型上;
4. 手指蘸水将印花移到适当的位置;
5. 用软布轻压印花直至水干，气泡消失。

DECAL APPLICATION

1. Cut off decal from sheet.
2. Dip the decal in tepid water 40°C for about 10 sec. and place on a clean cloth.
3. Hold the backing sheet edge and slide decal onto the model.
4. Move decal into position by wetting decal with finger.
5. Press decal gently down with a soft cloth until excess water and air bubbles are gone.
6. Allow decal to dry completely before handling model.

部品图 Parts

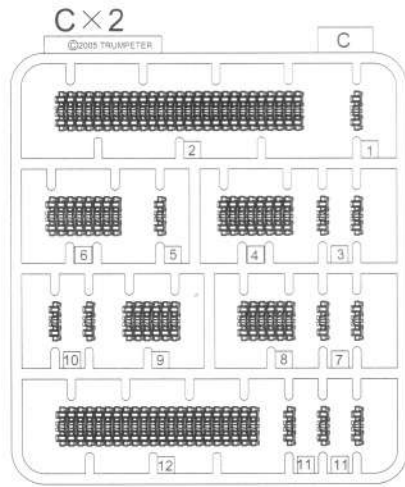
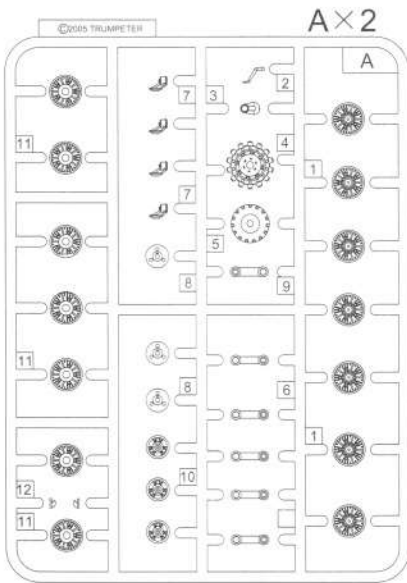
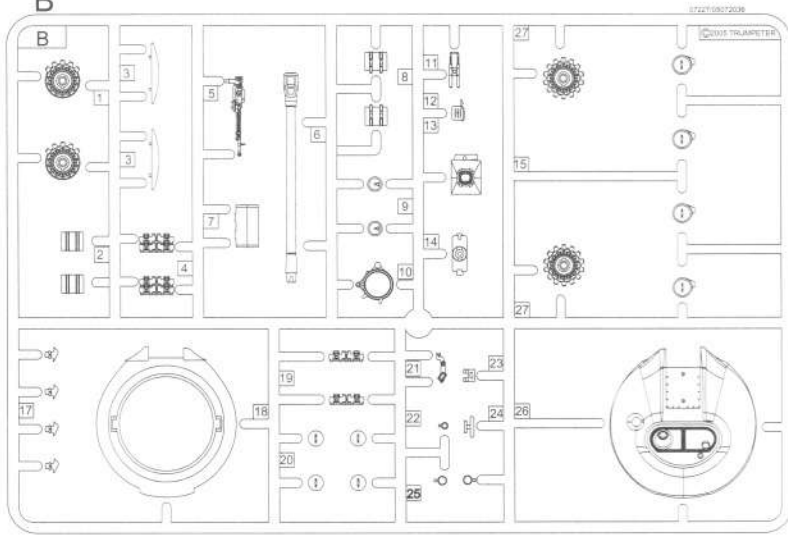

《铜线》
Brass wire x12

《车面》
Upper hull

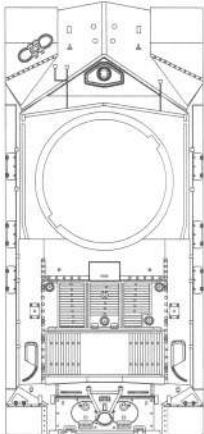

《底盘》
Lower hull

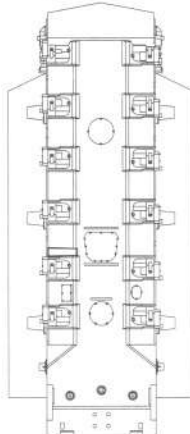

《履带》
Track

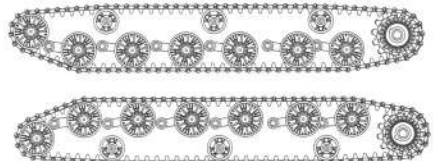

《水贴纸》
Decal



37227-37228 Russia JS-3m TANK

车轮组装
Wheels assembly

*参阅第4页车轮组装
Please refer to page 4 for assembly

任选一种车轮组装
Select one of two included
wheels for assembly

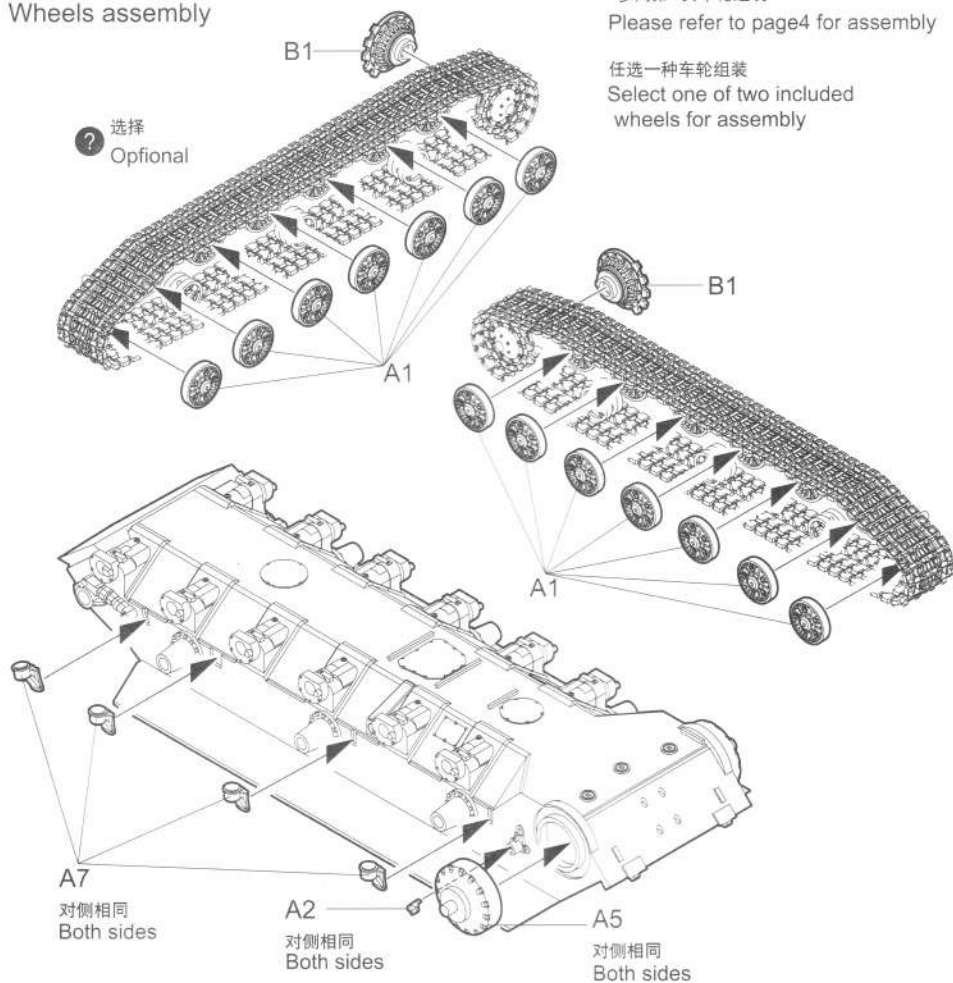

车轮安装
Attaching wheels

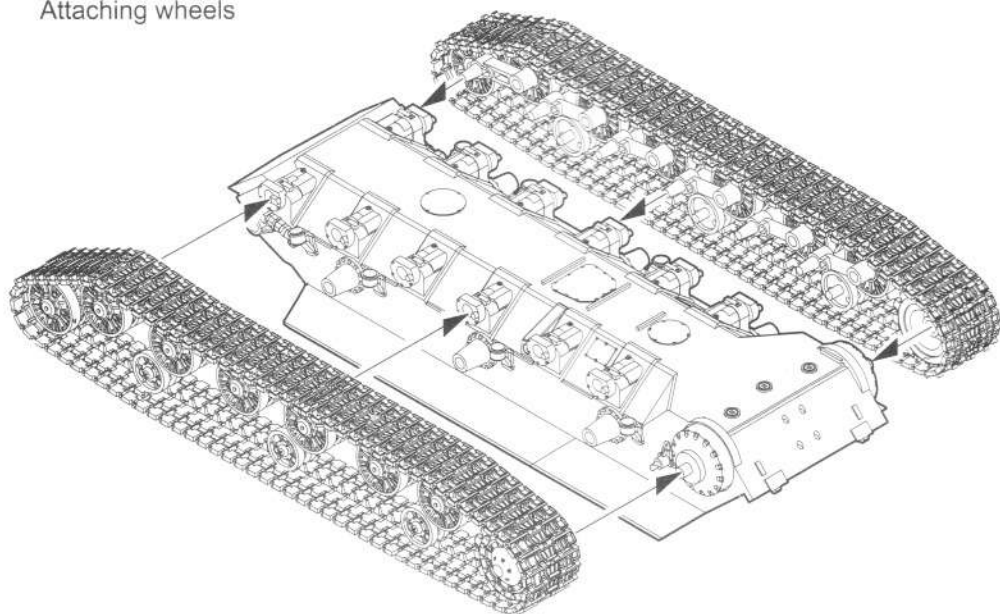

4 车轮安装
Attaching wheels

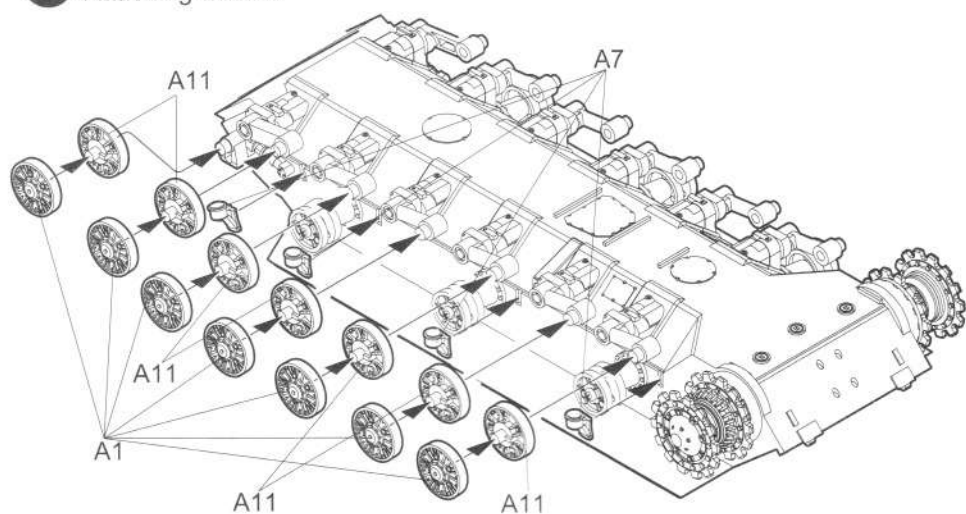

5 车轮安装
Attaching wheels

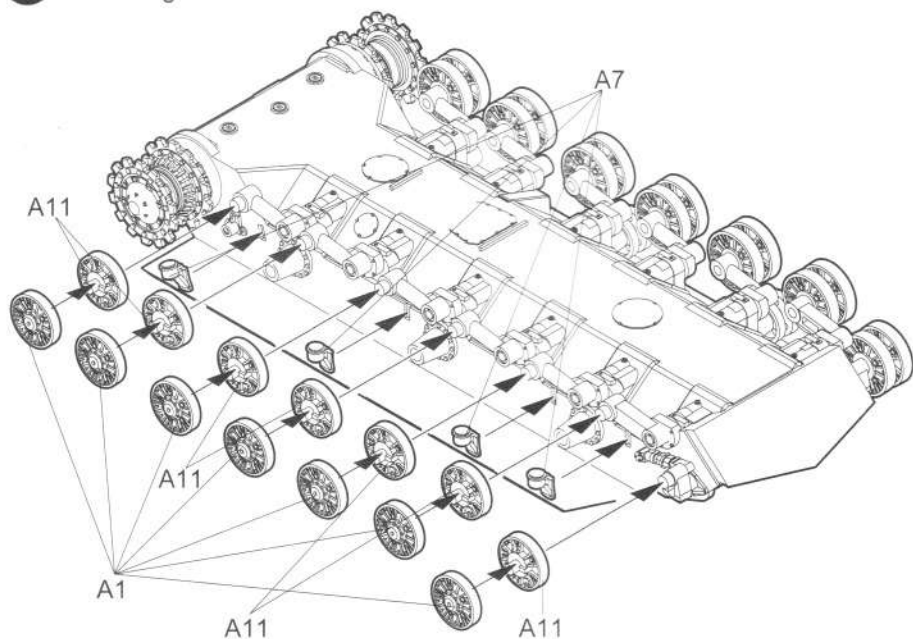

6 履带连接
Track

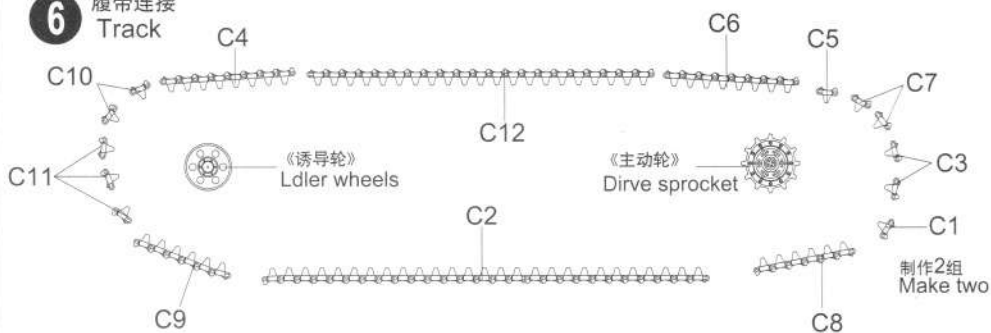

7 油桶组装
Fuel tank assembly

《部件 A》
Part A

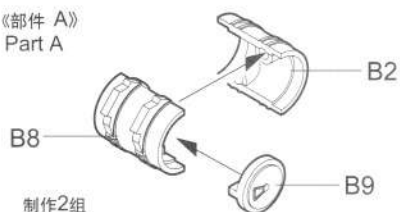

制作2组
Make two

《部件 B》
Part B

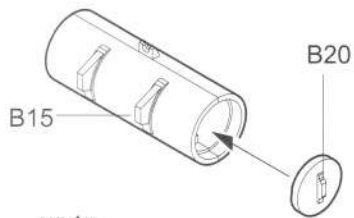

制作4组
Make four

8 车面组装
Upper hull assembly

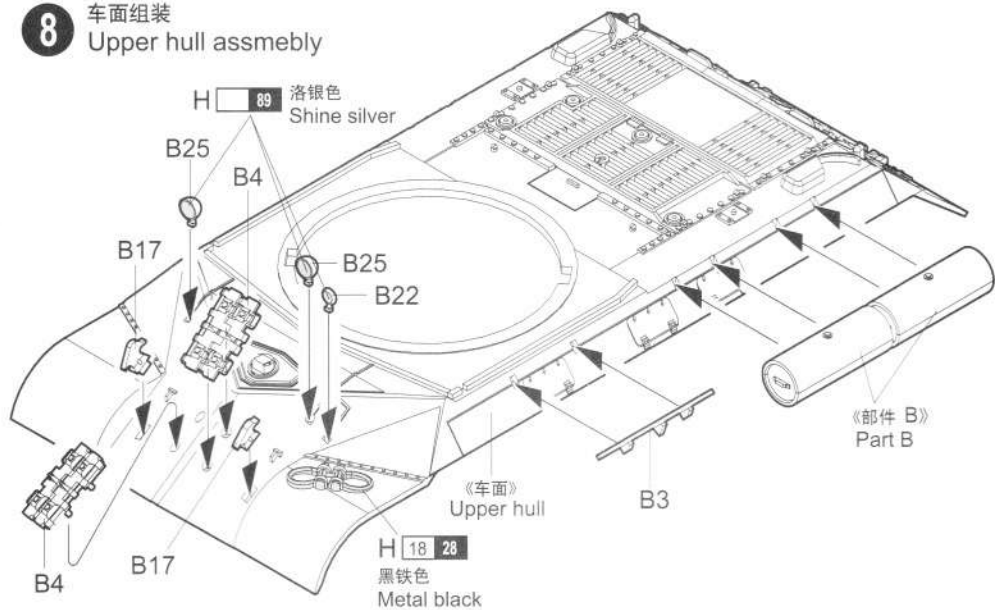

《部件 B》
Part B

《车面》
Upper hull

9 车面组装
Upper hull assembly

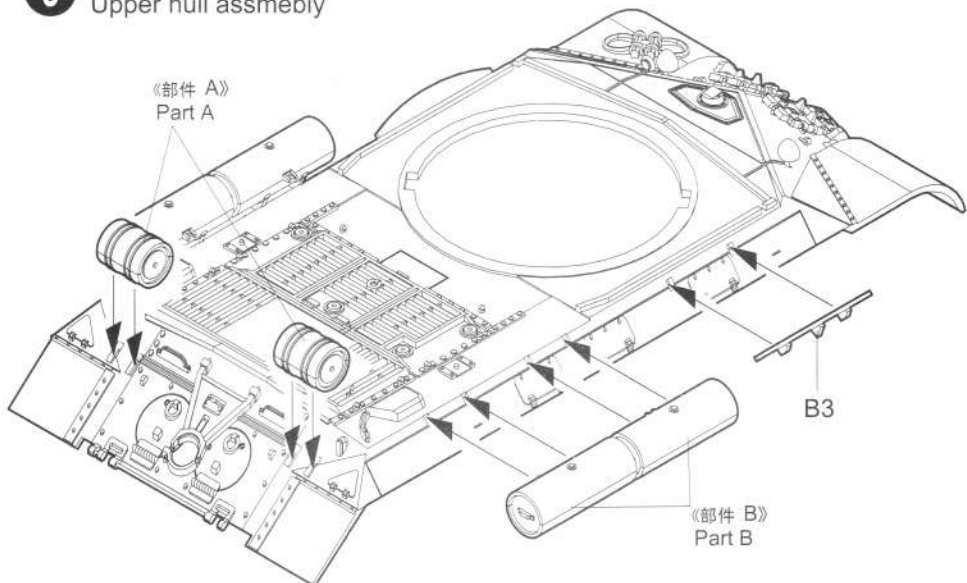

《部件 A》
Part A

《部件 B》
Part B

10 车面安装
Attaching upper hull

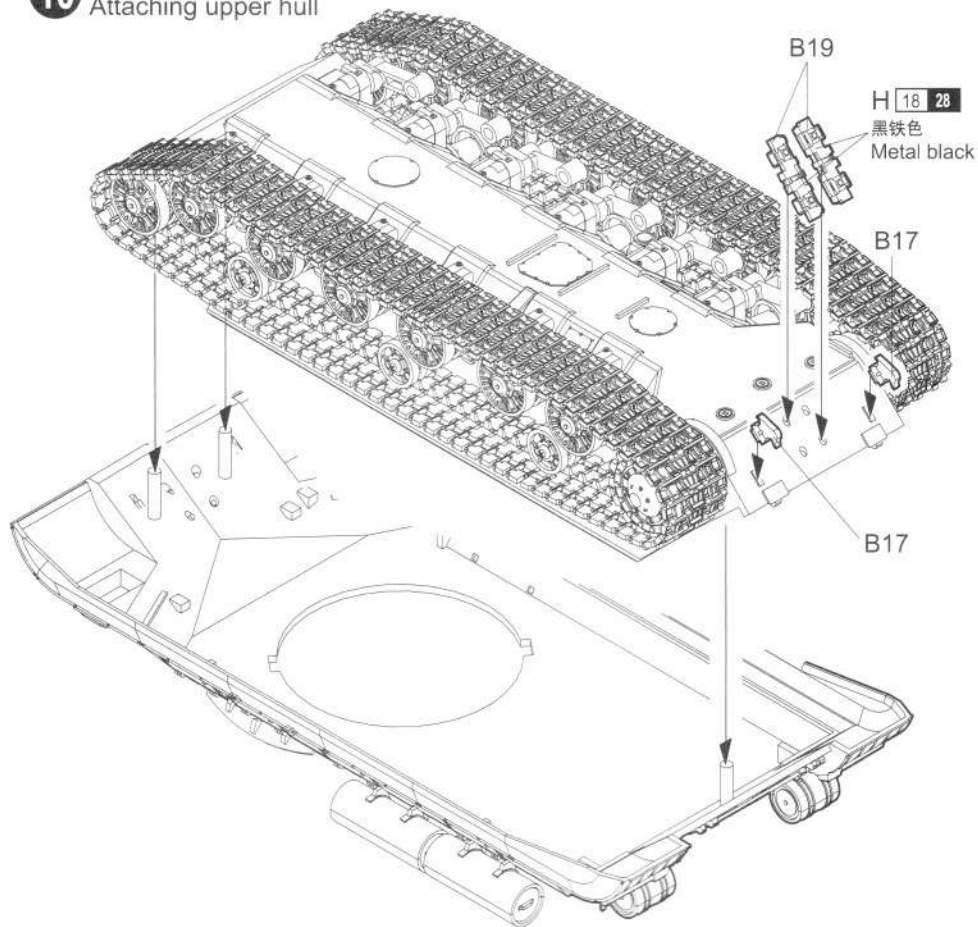

11 炮塔组装
Turret assembly

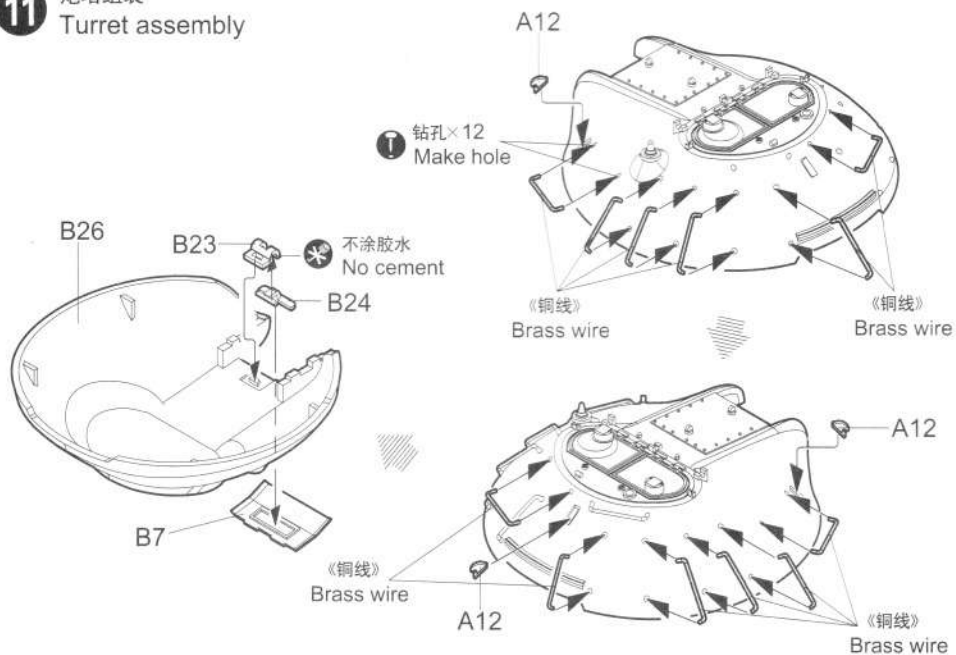

涂装同标贴指示 Painting & Marking guide

郡仕色使用

Gunze Mr. color used

A

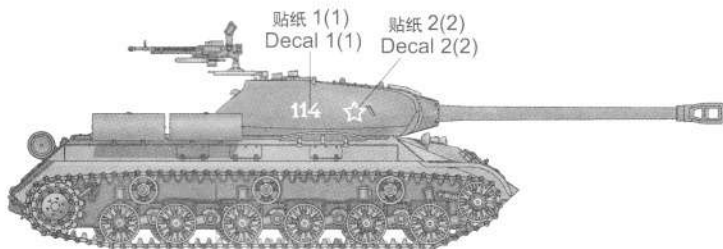

H 78 38

橄榄绿
Olive drab

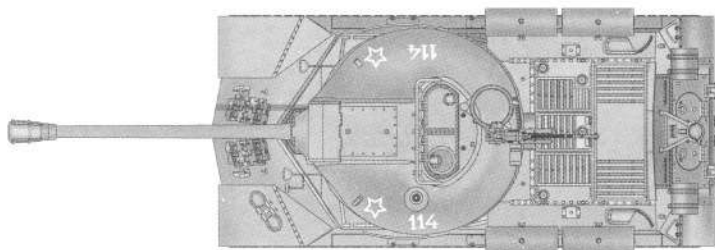
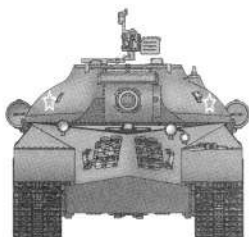

B

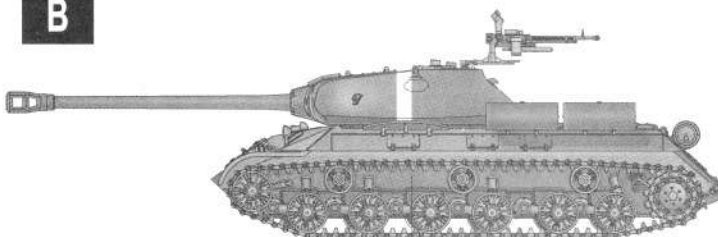

H 78 38

橄榄绿
Olive drab

H 316 316

白色
White Insignia

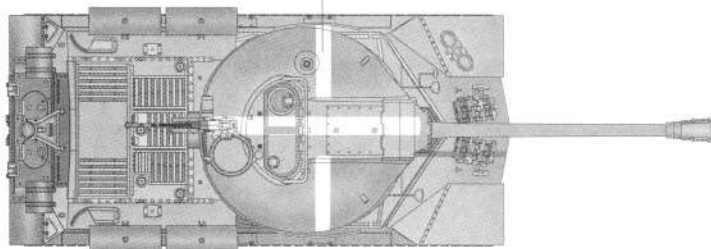
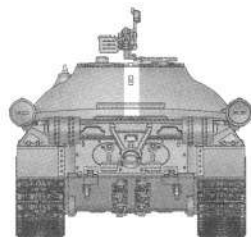

H X GUNZE SANGYO AQVEOUS HOBBY COLOUR

X GUNZE SANGYO MR COLOUR



07227-07228 Russia JS -3m TANK