

1:72 SCALE

ITEM NO.: 07255

# US ARMY M1126 "Stryker" ICV

美军 M1126 "斯崔克" 装甲运输车

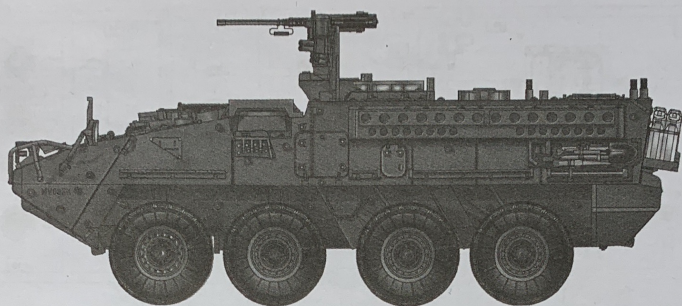

### READ BEFORE ASSEMBLY:

- This kit is not recommended for inexperienced modelers or for children under 14 years of age
- Study and understand these instructions thoroughly before beginning assembly
- When needed, remove photo-etch parts carefully using a modeling knife or photo etch sprue cutter, being careful not to damage or lose small parts.
- Take extra care in handling photo etch parts in order to avoid injury
- Apply instant cement sparingly to photo etch parts where instructed
- Tools recommended(not included in kit):Plastic and instant cements,sprue cutters,long nose pliers,,modeling knife, small files, tweezers, pin-vise & scissors. Soft cloth and sandpaper will also assist in construction
- Glue and paint are not included in the kit. Use plastic cement and hobby paints only. Color guide for purchasing paint is included in the kit.
- Keep out of reach of children. They must not be allowed to ingest small parts or handle plastic bags in any way.

### 装配之前仔细阅读

- 小心用模型锉刀锉平所有零件表面的注射浇口。
- 小心用刀片切下蚀刻片零件，不要遗失小零件。
- 用强力快干胶水粘合蚀刻片零件和金属轴。过量的快干胶水使用可能导致可动零件会粘住，小心涂胶。
- 取蚀刻片时应特别注意安全，防止利边划伤手指。
- 某些零件表面需贴水上贴纸，请选择在装配的同时进行。
- 推荐模型工具(自备)：胶水，水口剪刀，长咀钳，刀片，锉刀，镊子，钳，钻，剪刀，瞬间快干胶。
- 软布同砂纸同时也应该是必备工具。
- 请使用塑料胶水和油漆，模型内不含。
- 谨防小孩吮吸塑料零件，或者将塑料袋套在头上，制作时应将套材远离小孩接触。
- 本产品不适合14岁以下没有经验的模型爱好者。



cyanoacrylate glue  
使用强力胶



weight  
配重



make hole  
钻孔



cut / remove  
切除



bend  
弯曲



file / sand  
锉平



option  
选择



no cement  
不涂胶水



decal  
贴纸

### 水贴纸的使用:

1. 从水贴上剪下印花;
2. 将印花放入温水中浸10秒, 然后放在干净布上。
3. 拿着印花纸板将印花移到模型上;
4. 手指蘸水将印花移到适当的位置;
5. 用软布轻压印花直至水干, 气泡消失。

### DECAL APPLICATION

1. Cut off decal from sheet.
2. Dip the decal in tepid water 40°C for about 10 sec. and place on a clean cloth.
3. Hold the backing sheet edge and slide decal onto the model.
4. Move decal into position by wetting decal with finger.
5. Press decal gently down with a soft cloth until excess water and air bubbles are gone.
6. Allow decal to dry completely before handling model.

部品图  
parts

A

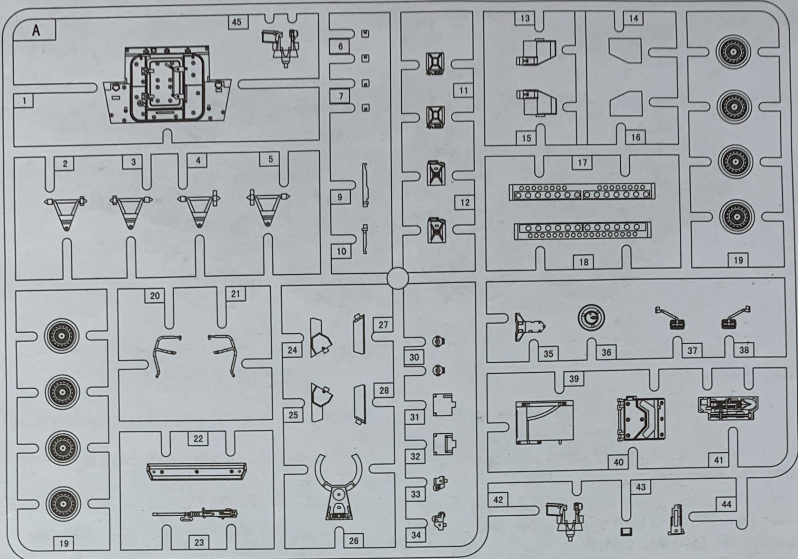

<<车面>>  
upper hull

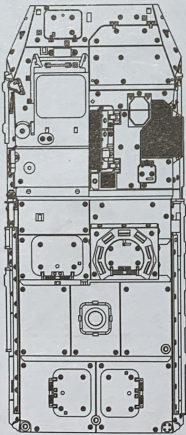

<<车底>>  
lower hull

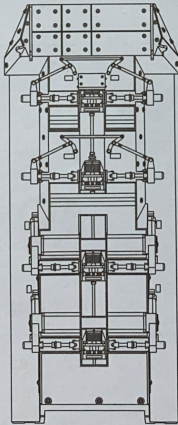

<<轮胎>>  
tyre x 8



<<水贴>>  
Decal

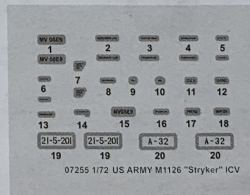

1

车底组装  
Lower hull assembly

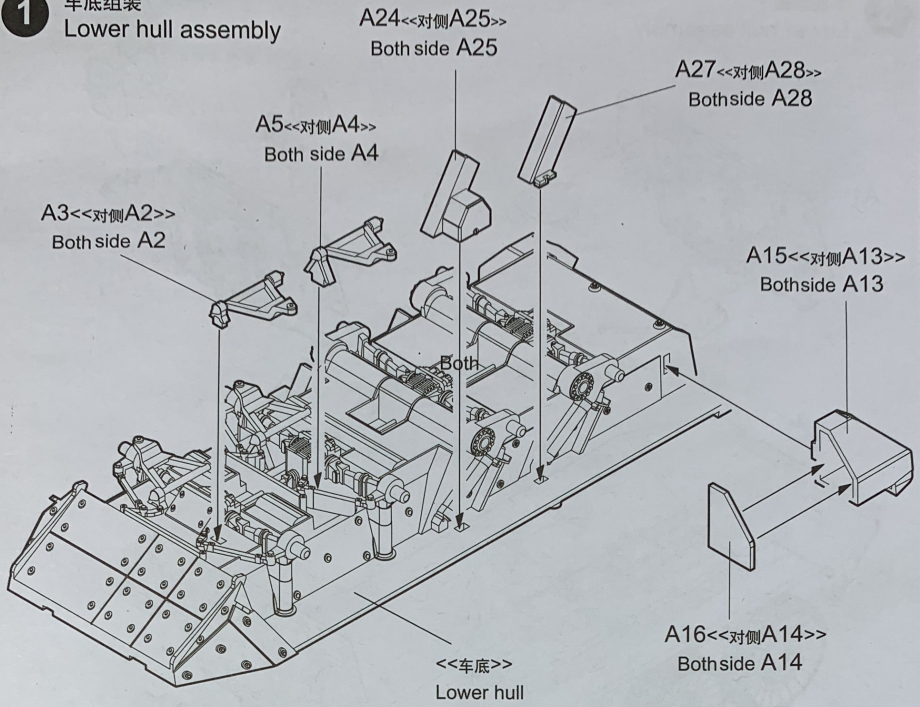

2

车底组装  
Lower hull assembly

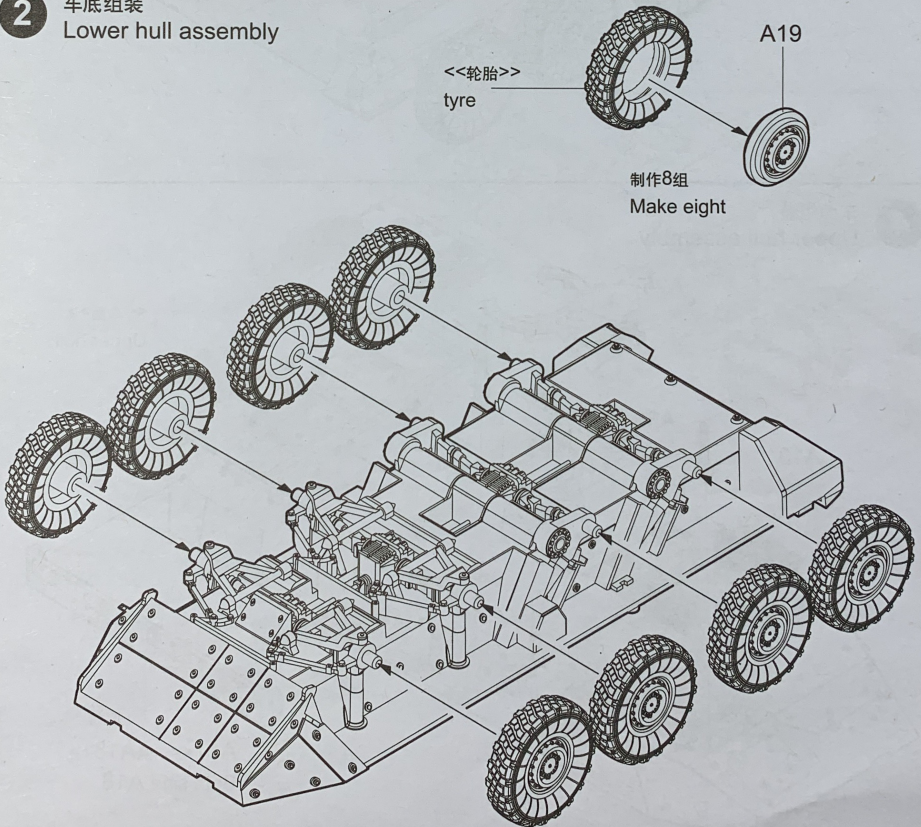

**3** 车底组装  
Lower hull assembly

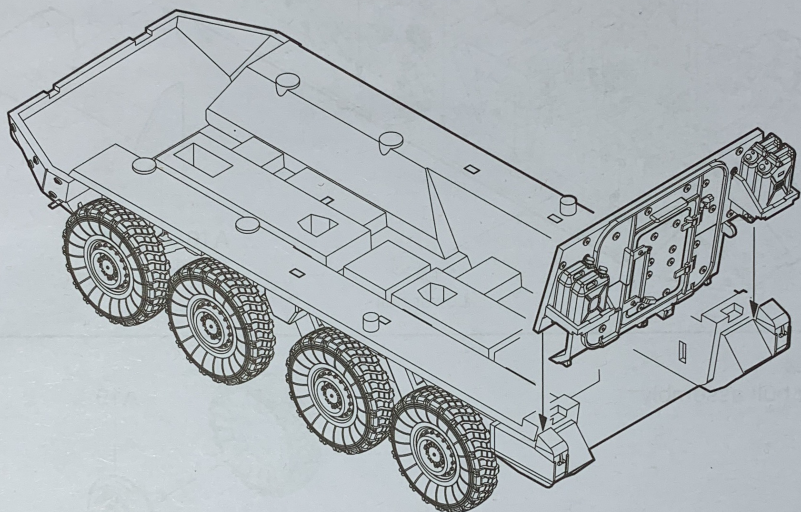
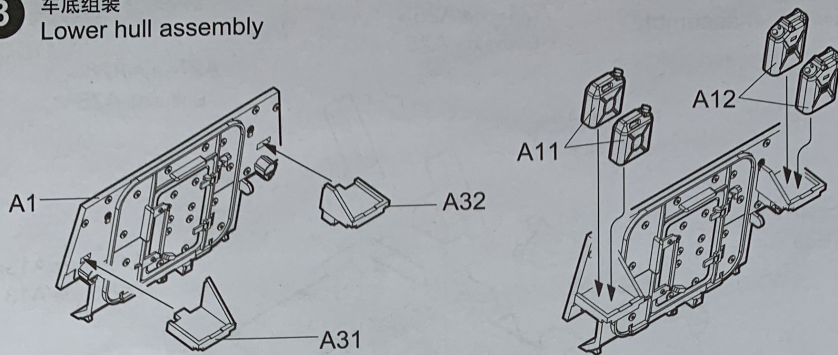

**4** 车面组装  
Upper hull assembly

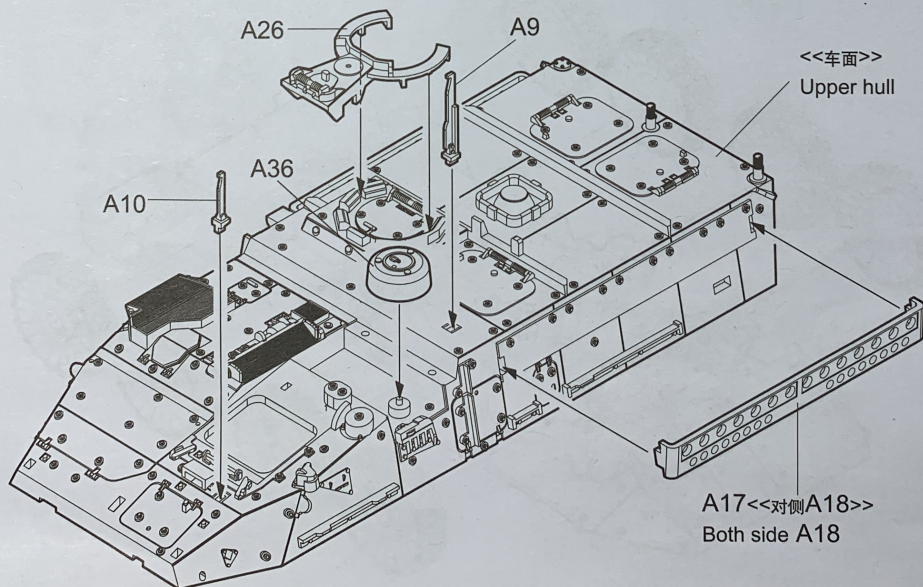

07255

4

**5** 车面组装  
Upper hull assembly

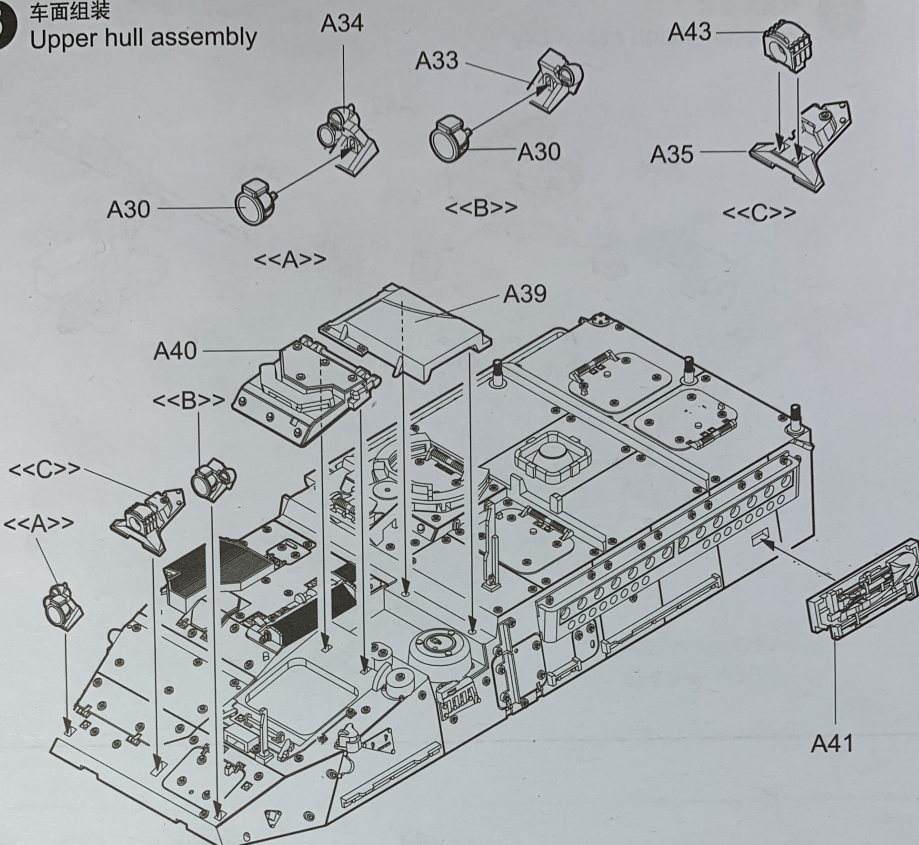

**6** 车面安装  
Upper hull installation

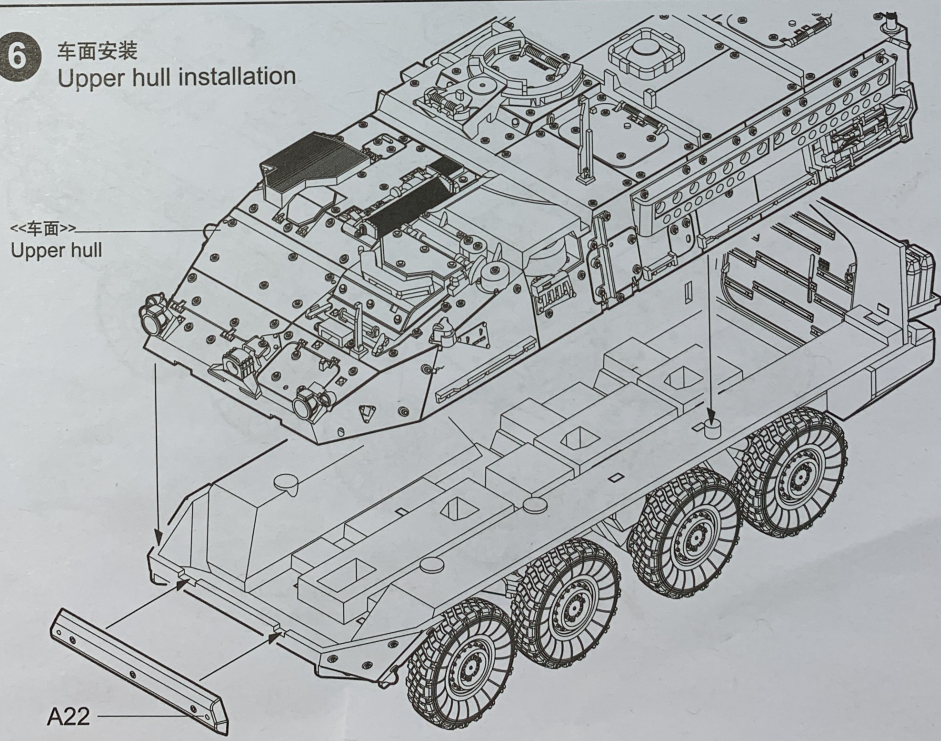

**7** 武器站组装  
 weapon station assembly

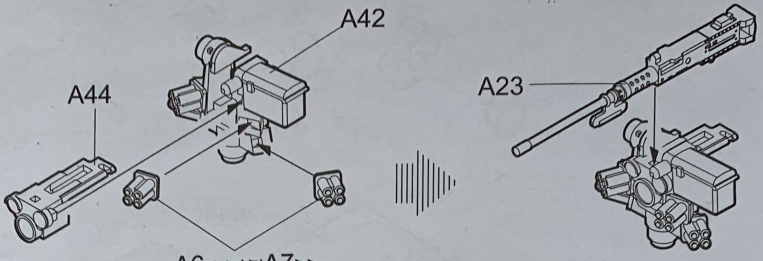

A6<<对侧A7>>  
 Both side A7

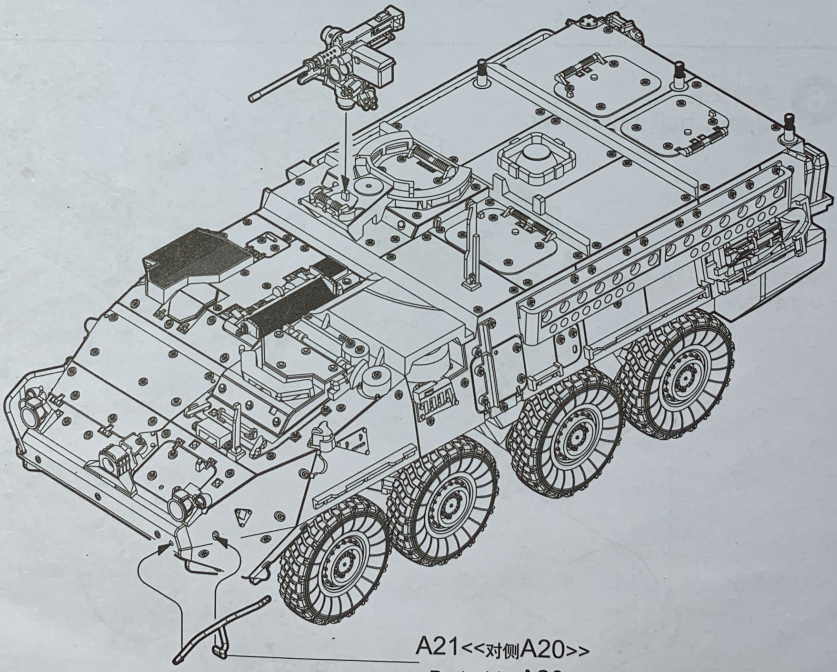
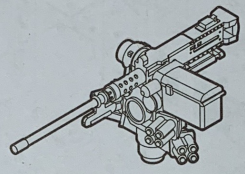

A21<<对侧A20>>  
 Bothside A20

8

后视镜组装  
Rearview mirror assembly

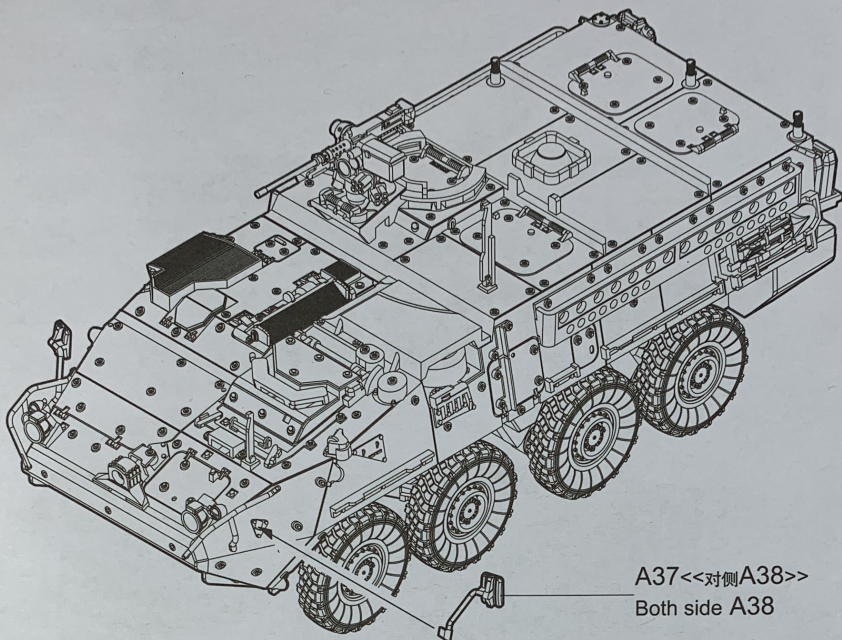

A37 <<对侧A38>>  
Both side A38

9

完成  
Accomplish

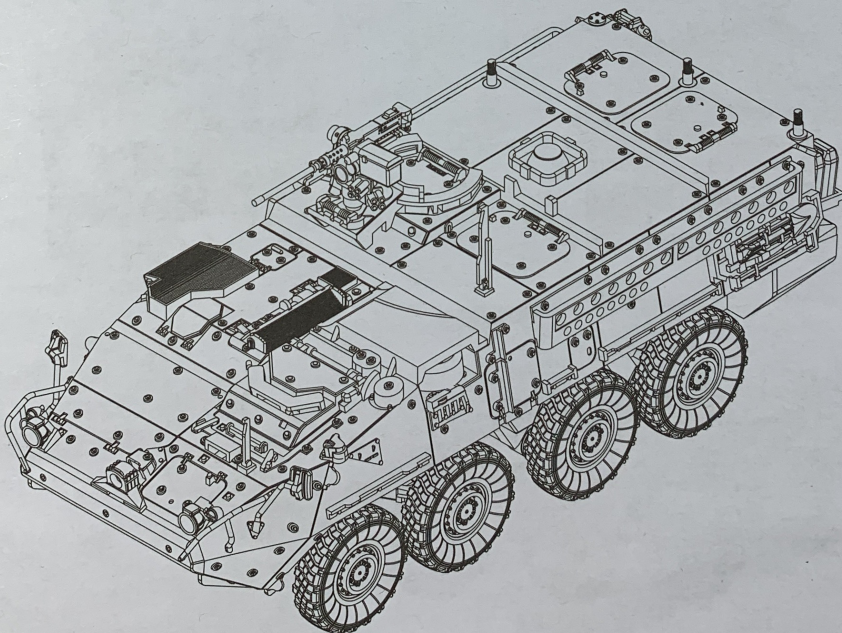

# 涂装同标贴指示 Painting & Marking guide

使用 MR.HOBBY 涂料 Mr.Color Used

Gunze			
H[37] 43	木棕色 Wood Brown	H[203] 303	绿色 Light Green
H[312] 312	绿色 Medium Grey Green	H[77] 137	胎黑色 Tire Black
H[93] 50	透明蓝 Clear Blue	H[52] 40	透明绿 Clear Green

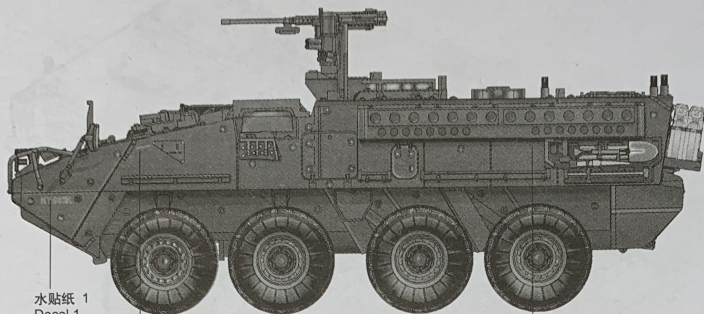

水贴纸 1  
Decal 1

水贴纸 5  
Decal 5

水贴纸 13  
Decal 13

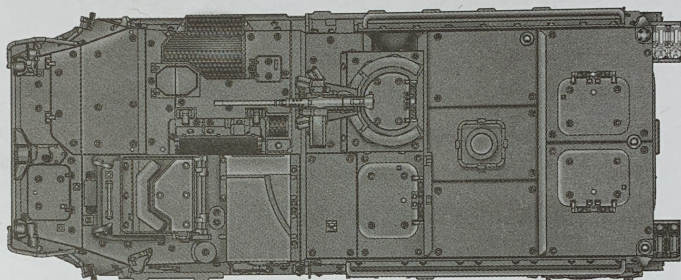

H[93] 50  
透明蓝 Clear Blue

水贴纸 14  
Decal 14

水贴纸 12  
Decal 12

水贴纸 2  
Decal 2

215-20

A-32

水贴纸 2  
Decal 2

水贴纸 3  
Decal 3

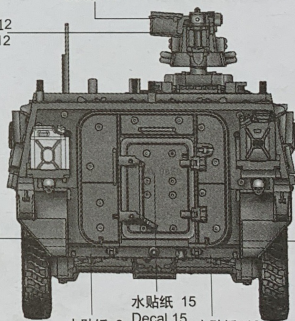

水贴纸 3  
Decal 3

水贴纸 19  
Decal 19

水贴纸 20  
Decal 20

水贴纸 3  
Decal 3

水贴纸 3  
Decal 3

水贴纸 15  
Decal 15

水贴纸 8  
Decal 8

水贴纸 16  
Decal 16

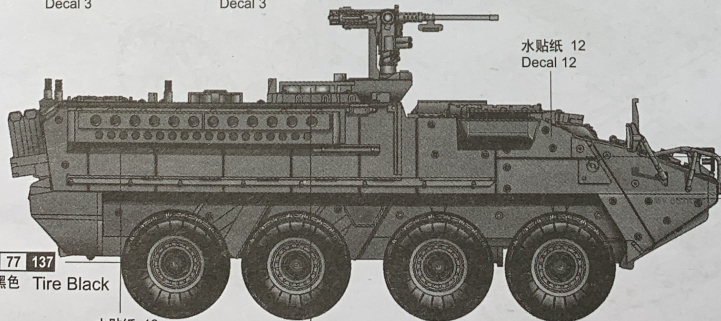

水贴纸 12  
Decal 12

水贴纸 6  
Decal 6

水贴纸 1  
Decal 1

H[77] 137  
胎黑色 Tire Black

水贴纸 13  
Decal 13

H[93] 50  
透明蓝 Clear Blue

H[X] AQUEOUS HOBBY COLOUR

[X] MR.COLOUR