

1:72 SCALE

ITEM NO.: 07293

Germany Sd.Kfz. 186 JagdTiger (Henschel Suspension) w/Zimmerit

德国“猎虎”(亨舍尔型)歼击坦克/防磁装甲

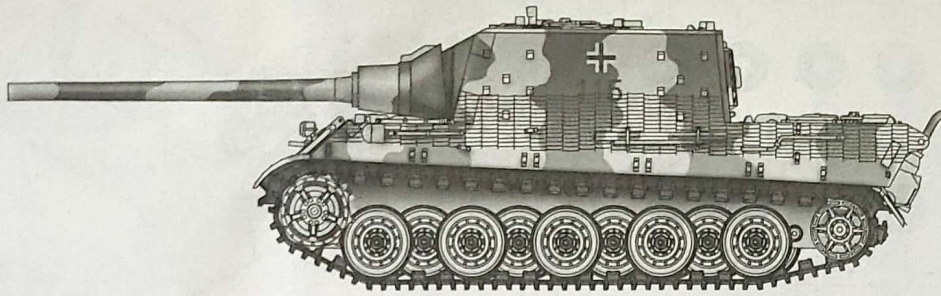

READ BEFORE ASSEMBLY:

- Study and understand these instructions thoroughly before beginning assembly
- When needed, remove photo-etch parts carefully using a modeling knife or photo etch sprue cutter, being careful not to damage or lose small parts.
- Take extra care in handling photo etch parts in order to avoid injury
- Apply instant cement sparingly to photo etch parts where instructed
- Tools recommended(not included in kit):Plastic and instant cements,sprue cutters,long nose pliers,,modeling knife, small files, tweezers, pin vise & scissors. Soft cloth and sandpaper will also assist in construction
- Glue and paint are not included in the kit. Use plastic cement and hobby paints only. Color guide for purchasing paint is included in the kit.

装配之前仔细阅读

- 小心用模型锉刀锉平所有零件表面的注射浇口。
- 小心用刀片切下蚀刻片零件，不要遗失小零件。
- 用强力快干胶水粘合蚀刻片零件和金属轴。过量的快干胶水使用可能导致可动零件会粘住，小心涂胶。
- 取蚀刻片时应特别注意安全，防止利边划伤手指。
- 某些零件表面需贴水贴纸，请选择在装配的同时进行。
- 推荐模型工具(自备)：胶水，水口剪刀，长咀钳，刀片，锉刀，镊子，钳，钻，剪刀，瞬间快干胶。
- 软布同砂纸同时也应该是必备工具。
- 请使用塑料胶水和油漆，模型内不含。



cyanoacrylate glue
使用强力胶



weight
配重



make hole
钻孔



cut / remove
切除



bend
弯曲



file / sand
锉平



option
选择



no cement
不涂胶水



decal
贴纸

水贴纸的使用:

1. 从水贴上剪下印花;
2. 将印花放入温水中浸10秒, 然后放在干净布上.
3. 拿着印花纸板将印花移到模型上;
4. 手指蘸水将印花移到适当的位置;
5. 用软布轻压印花直至水干, 汽泡消失.

DECAL APPLICATION

1. Cut off decal from sheet.
2. Dip the decal in tepid water 40°C for about 10 sec. and place on a clean cloth.
3. Hold the backing sheet edge and slide decal onto the model.
4. Move decal into position by wetting decal with finger.
5. Press decal gently down with a soft cloth until excess water and air bubbles are gone.
6. Allow decal to dry completely before handling model.

部品图
Parts

Ax2

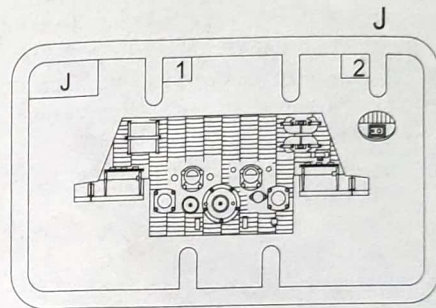
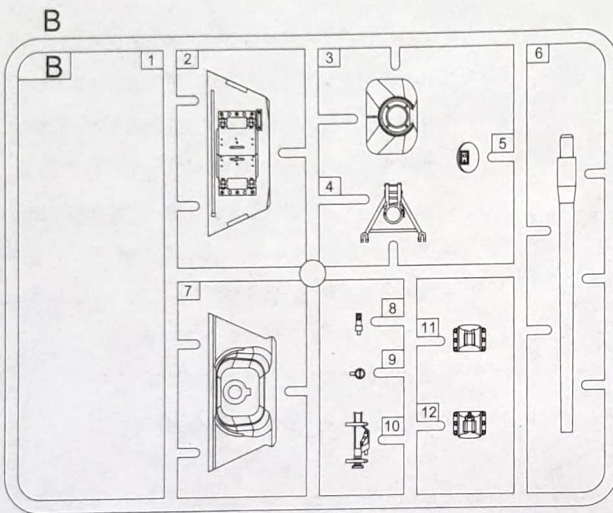
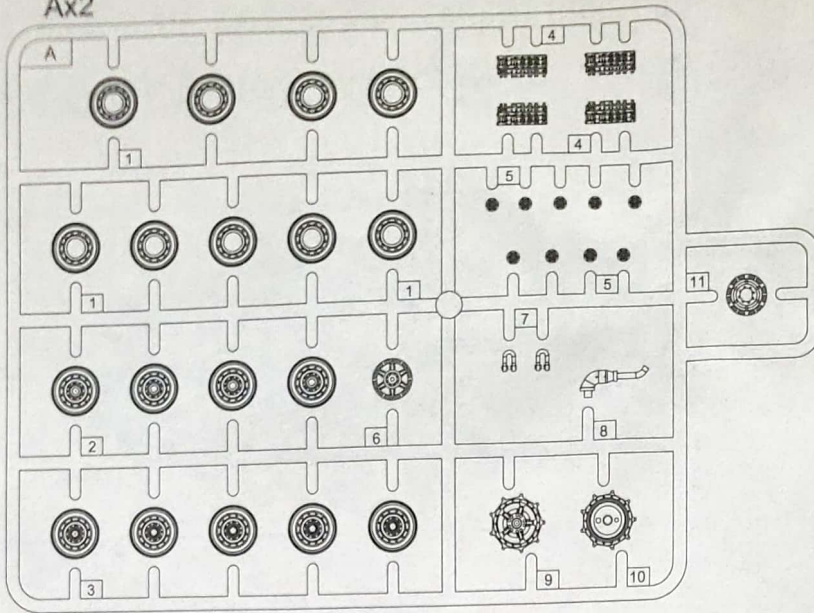

《贴纸》
Decal

1 314 2 314

3 115 4 115

07254 07273 07293 07294
1/72 Scale Jage Tiger

《车面》
Upper hull

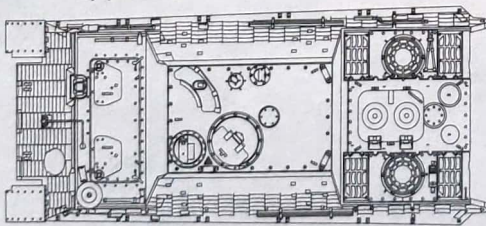

《车底》
Lower hull

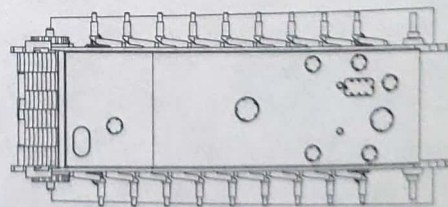

《履带》
Track

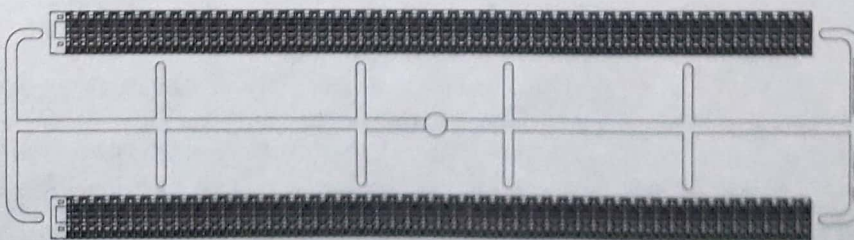

不用部件: B5
Unused parts:

1 车轮组装
Wheels assembly

《负重轮(A)》
Road wheel(A)

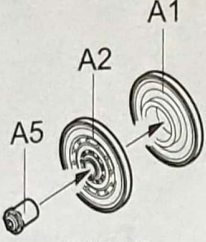

制作8组
Make eight

《负重轮(B)》
Road wheel(B)

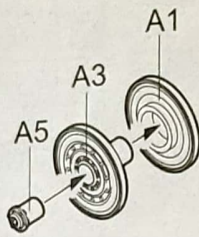

制作10组
Make ten

《主动轮》
Sprocket wheel

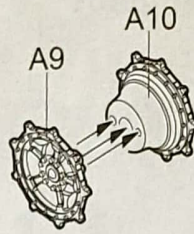

制作2组
Make two

《诱导轮》
Ldler wheels

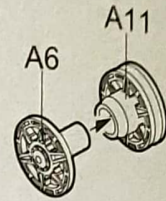

制作2组
Make two

2 车轮安装
Attaching wheel

《主动轮》
Sprocket wheel

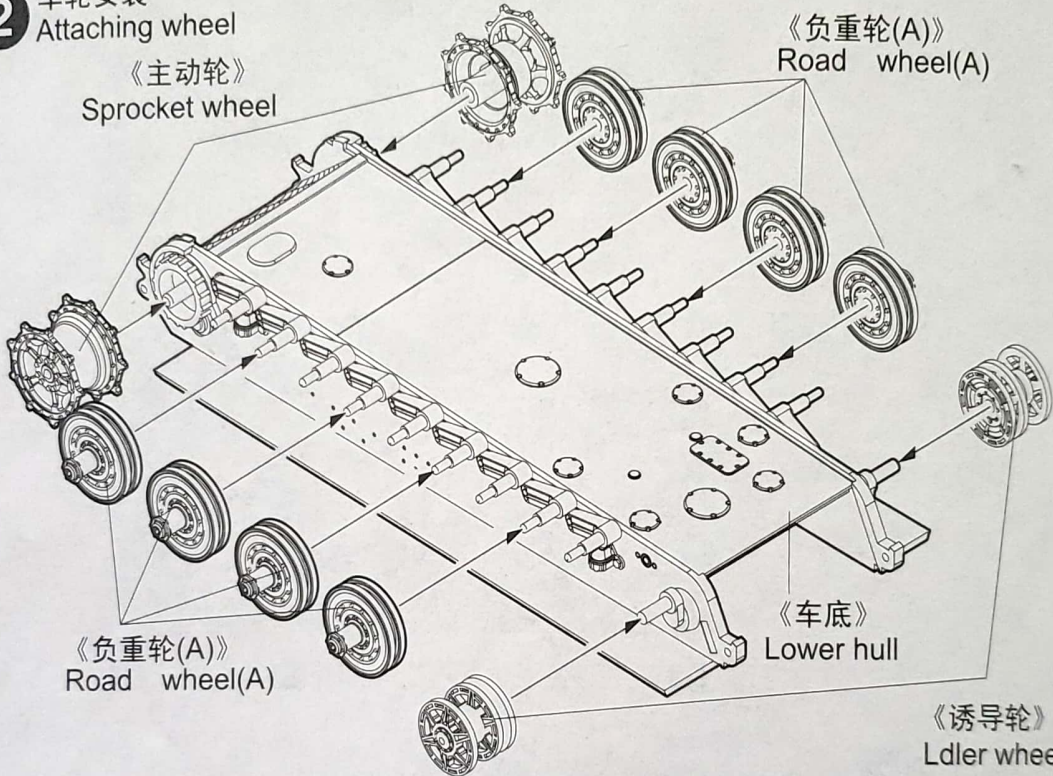

3 车轮安装
Attaching wheel

《负重轮(B)》
Road wheel(B)

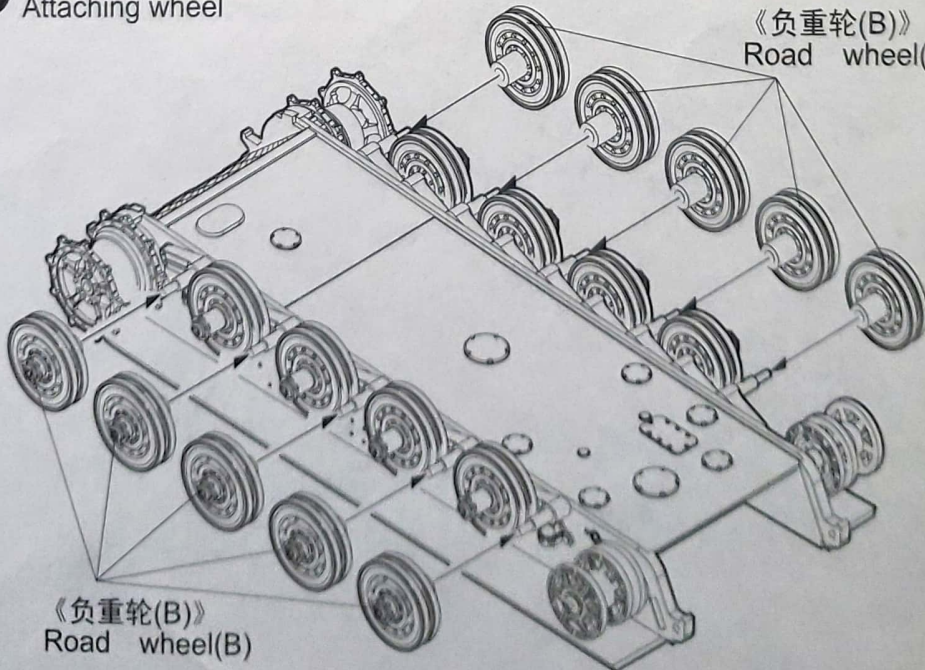

4 后板安装
Attaching rear panel

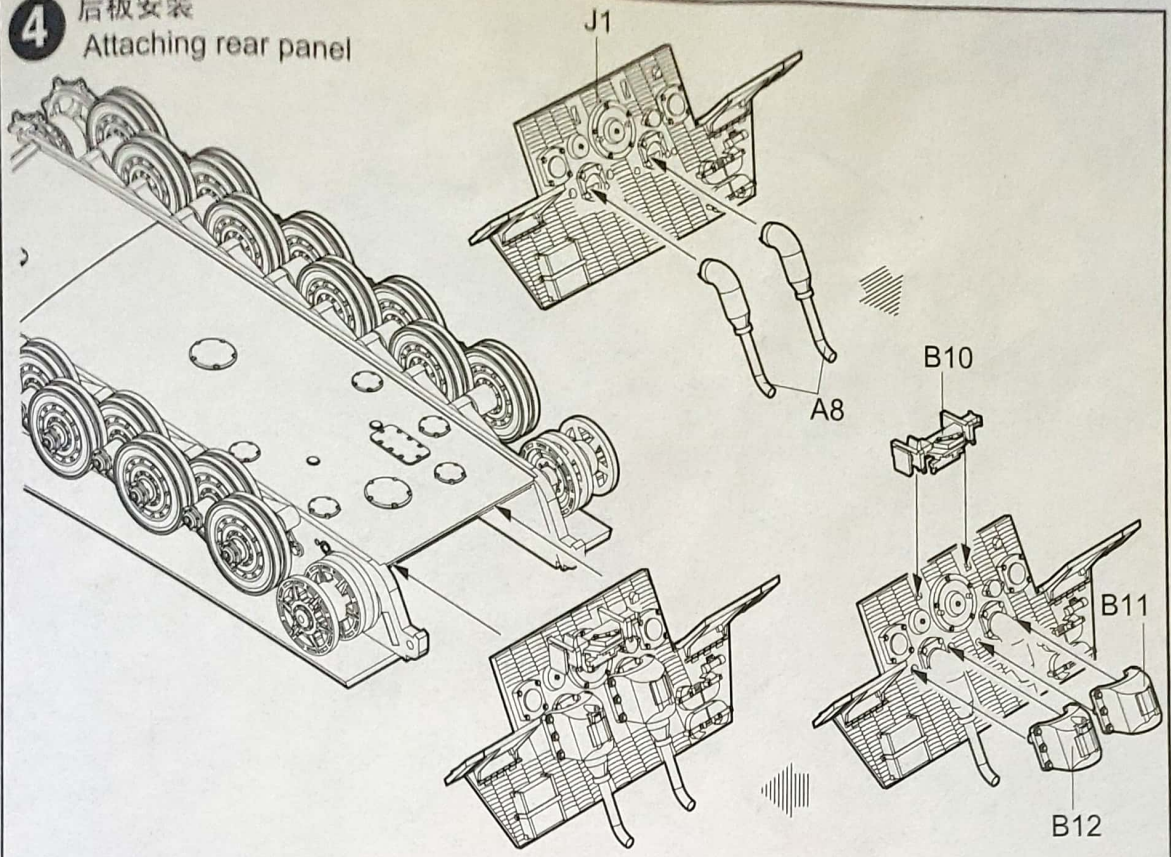

5 履带联接
Track construction

- * 履带可用塑料胶水粘合。
- * 履带可用模型油漆喷涂。
- * 若履带断裂，用细丝线固定。
- * The tracks in this kit can be glued using plastic cement.
- * The tracks can be painted using plastic paints.
- * If track is broken strengthen with staples or thread.

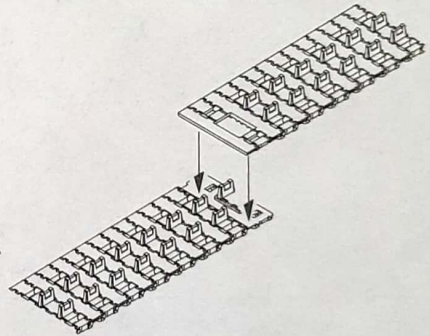

6 履带安装
Attaching track

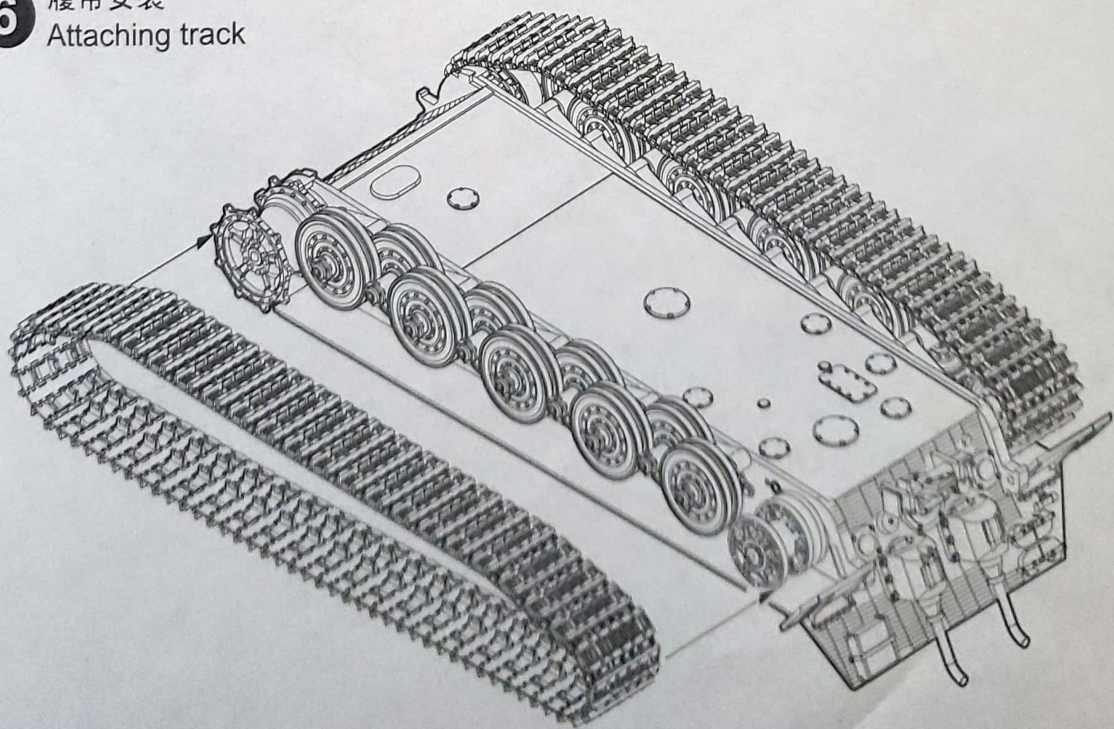

7 炮塔组装
Turret assembly

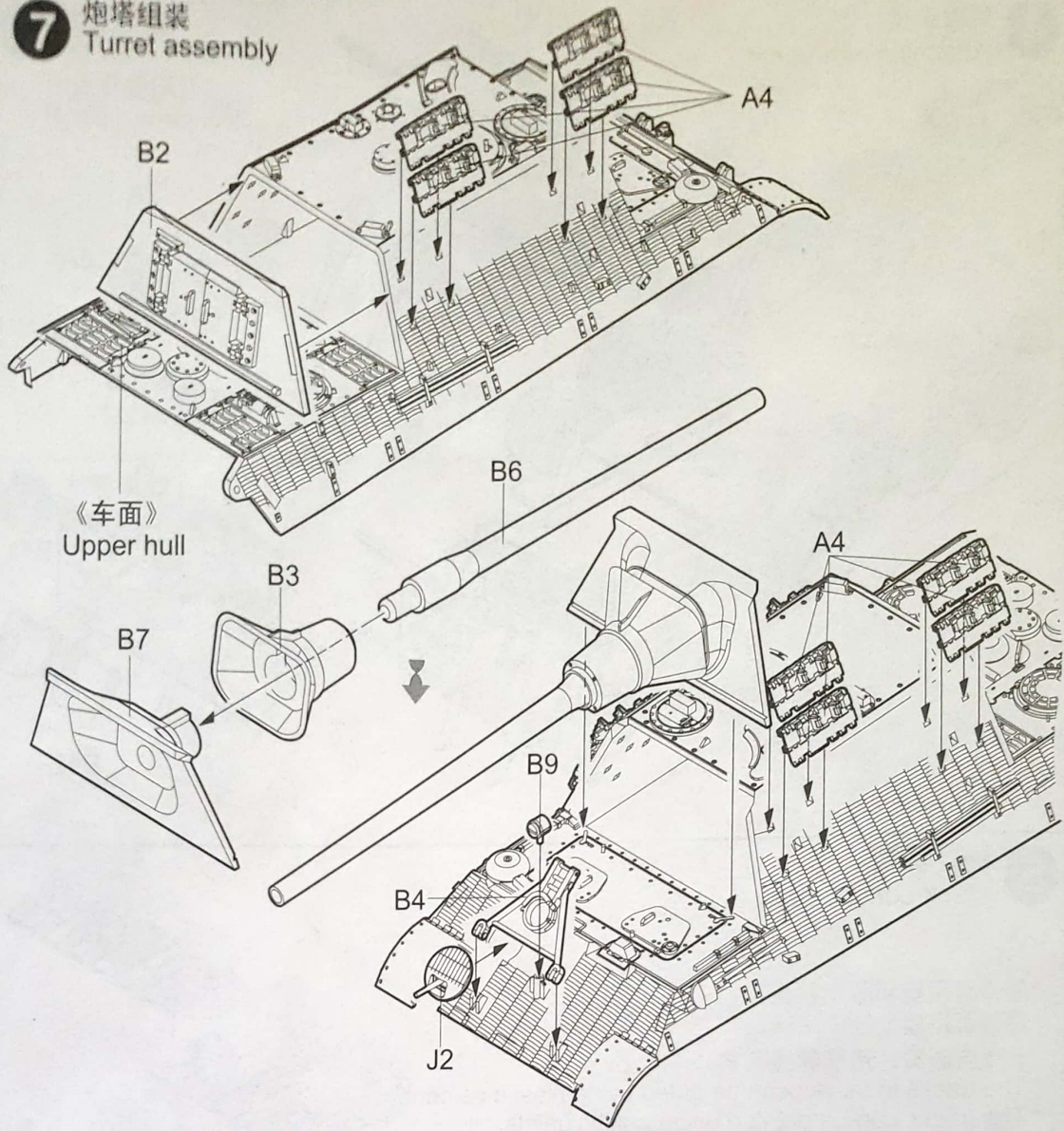

8 炮塔安装
Attaching turret

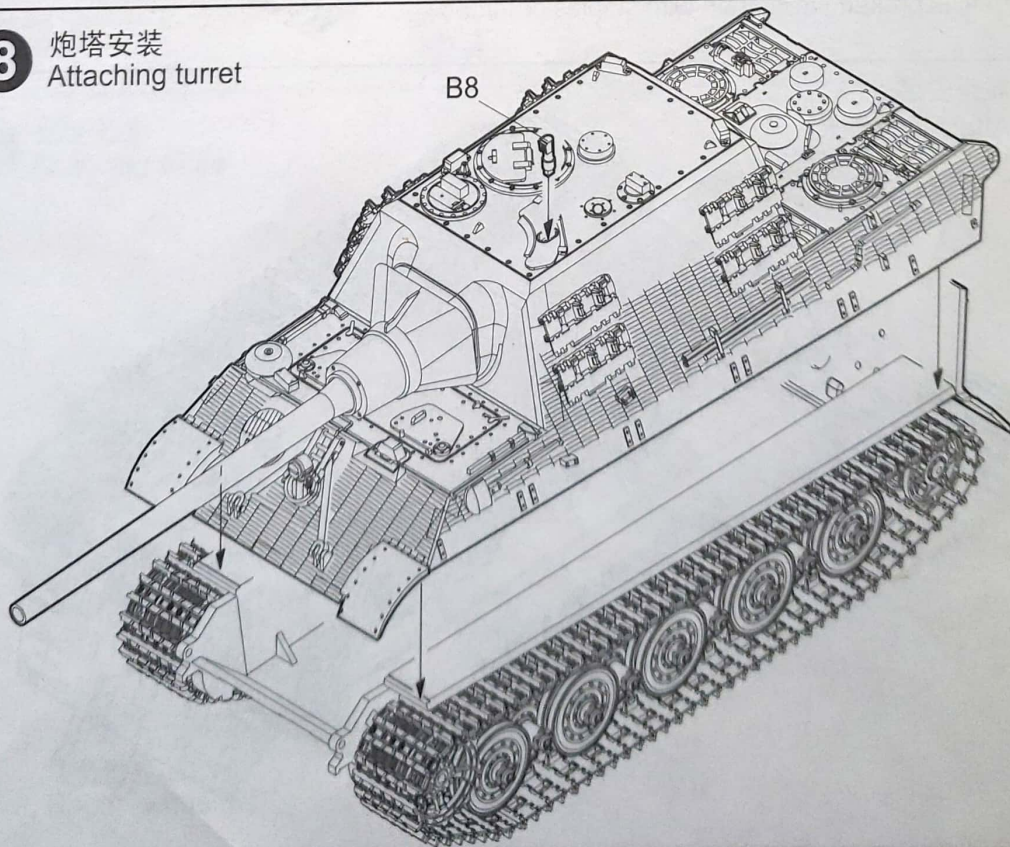

涂装同标贴指示 Painting & Marking guide

Color	Mr.Hobby	Vallejo	Model Master	Tamiya	Humbrol
Sandy Brown 砂黄色	H 79 39	824	-	XF59	93
Red Brown 红棕色	H 47 41	984	-	XF64	160
Dark Green 暗绿色	H 70	-	-	-	-

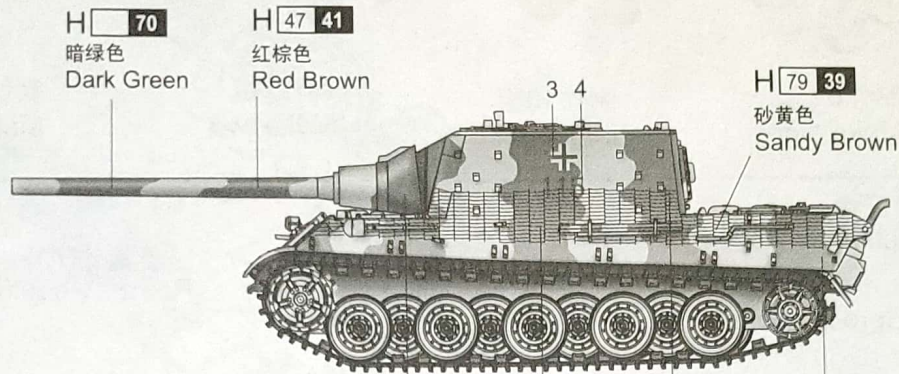

H 70 暗绿色 Dark Green H 47 41 红棕色 Red Brown H 70 暗绿色 Dark Green H 47 41 红棕色 Red Brown

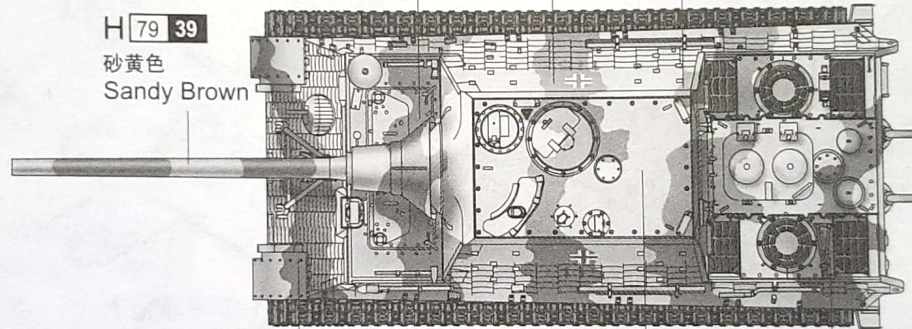

H 47 41 红棕色 Red Brown H 70 暗绿色 Dark Green H 47 41 红棕色 Red Brown H 47 41 红棕色 Red Brown

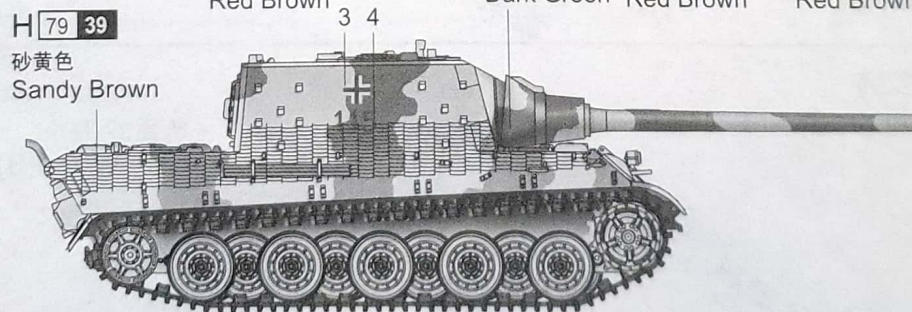

H 70 暗绿色 Dark Green

H 47 41 红棕色 Red Brown

H 79 39 砂黄色 Sandy Brown

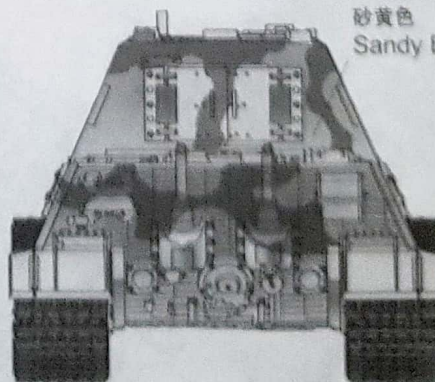
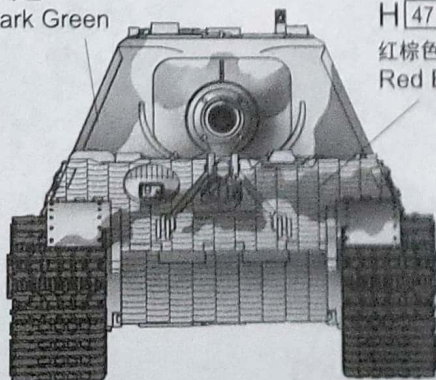

□ AQUEOUS HOBBY COLOR ■ Mr. COLOR