

1/72 SCALE

ITEM NO.: 07143

Soviet JS-4 Heavy Tank

苏联JS-4重型坦克



READ BEFORE ASSEMBLY:

- Study and understand these instructions thoroughly before beginning assembly
- When needed, remove photo-etch parts carefully using a modeling knife or photo etch sprue cutter, being careful not to damage or lose small parts.
- Take extra care in handling photo etch parts in order to avoid injury
- Apply instant cement sparingly to photo etch parts where instructed
- Tools recommended(not included in kit):Plastic and instant cements,sprue cutters,long nose pliers,,modeling knife, small files, tweezers, pin vise & scissors. Soft cloth and sandpaper will also assist in construction
- Glue and paint are not included in the kit. Use plastic cement and hobby paints only. Color guide for purchasing paint is included in the kit.

装配之前仔细阅读

- 小心用模型锉刀锉平所有零件表面的注射浇口。
- 小心用刀片切下蚀刻片零件，不要遗失小零件。
- 用强力快干胶水粘合蚀刻片零件和金属轴。过量的快干胶水使用可能导致可动零件会粘住，小心涂胶。
- 取蚀刻片时应特别注意安全，防止利边划伤手指。
- 某些零件表面需贴水上贴纸，请选择在装配的同时进行。
- 推荐模型工具(自备)：胶水，水口剪刀，长咀钳，刀片，锉刀，镊子，钳，钻，剪刀，瞬间快干胶。
- 软布同砂纸同时也应该是必备工具。
- 请使用塑料胶水和油漆，模型内不含。



cyanoacrylate glue
使用强力胶



weight
配重



make hole
钻孔



cut / remove
切除



bend
弯曲



file / sand
锉平



option
选择



no cement
不涂胶水



decal
贴纸



先装
Install it first

水贴纸的使用:

1. 从水贴上剪下印花;
2. 将印花放入温水中浸10秒, 然后放在干净布上。
3. 拿着印花纸板将印花移到模型上;
4. 手指蘸水将印花移到适当的位置;
5. 用软布轻压印花直至水干, 气泡消失。

DECAL APPLICATION

1. Cut off decal from sheet.
2. Dip the decal in tepid water 40°C for about 10 sec. and place on a clean cloth.
3. Hold the backing sheet edge and slide decal onto the model.
4. Move decal into position by wetting decal with finger.
5. Press decal gently down with a soft cloth until excess water and air bubbles are gone.
6. Allow decal to dry completely before handling model.

部品图 Parts

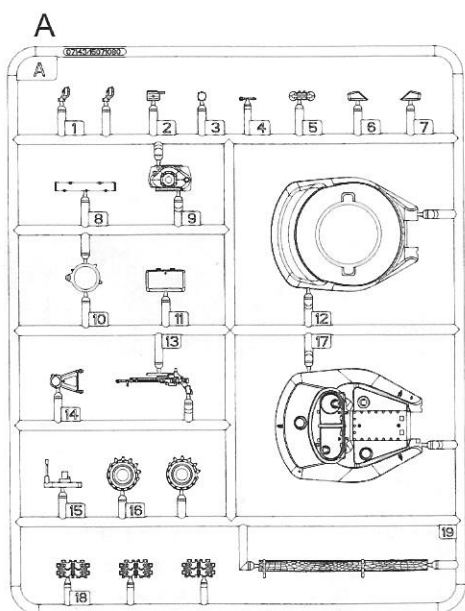

《车面》
Upper hull

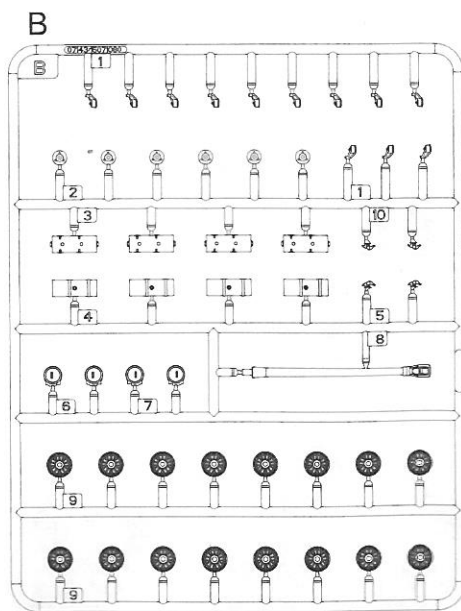

《车底》
Lower hull

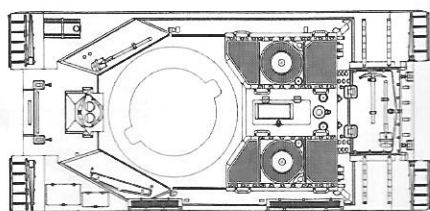

《左侧履带》
Left track

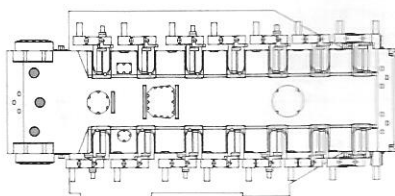

《右侧履带》
Right track

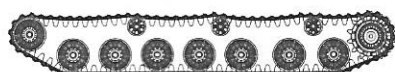

《水贴》
Decal



1

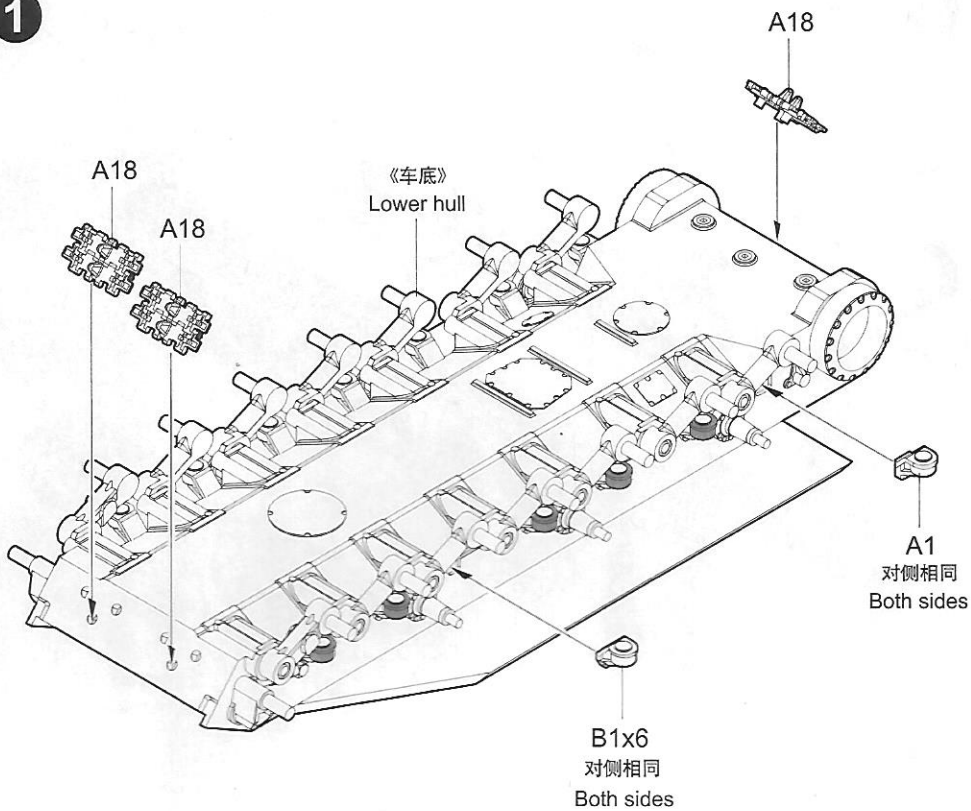

2

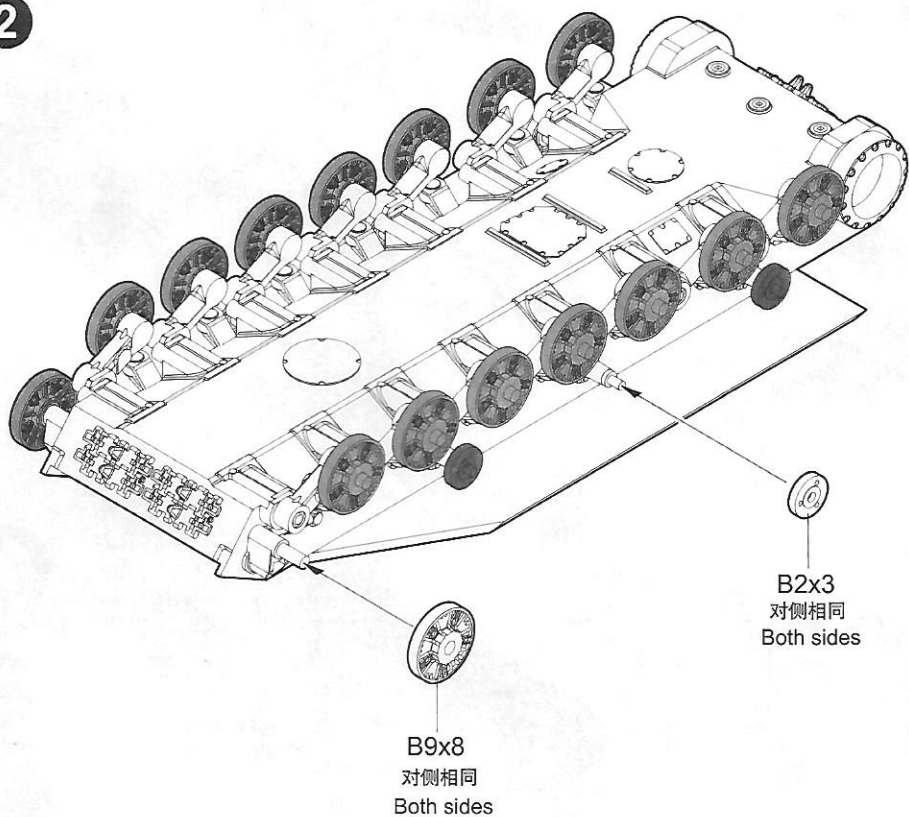

3

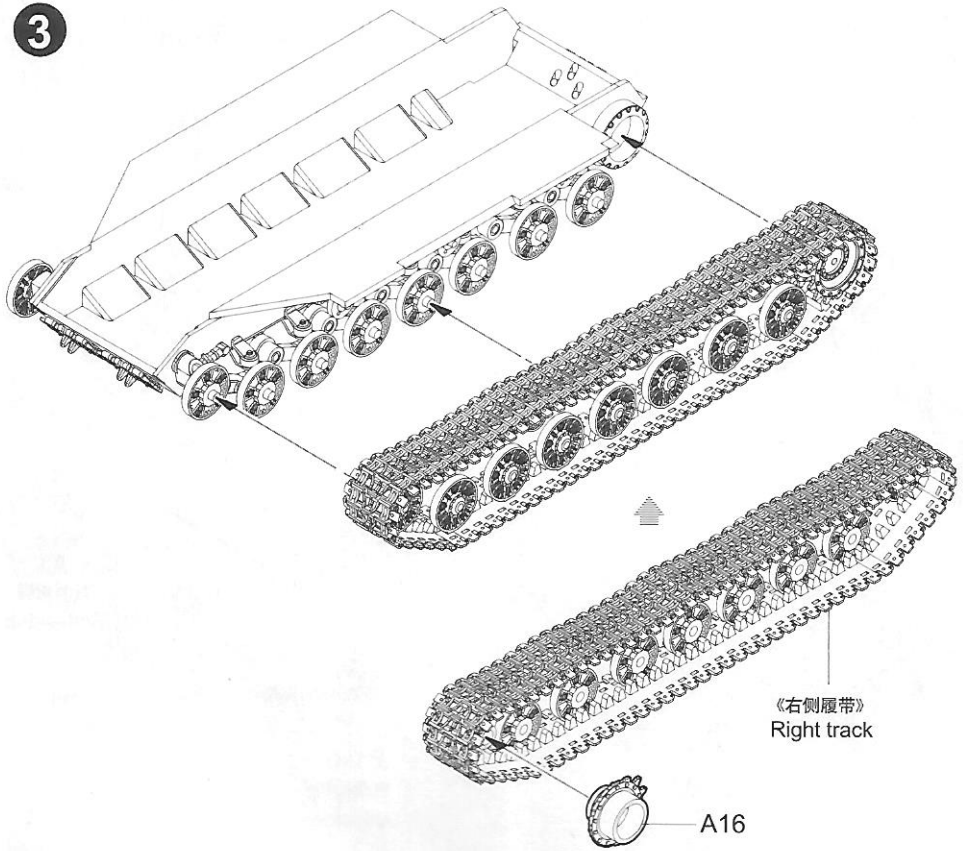

4

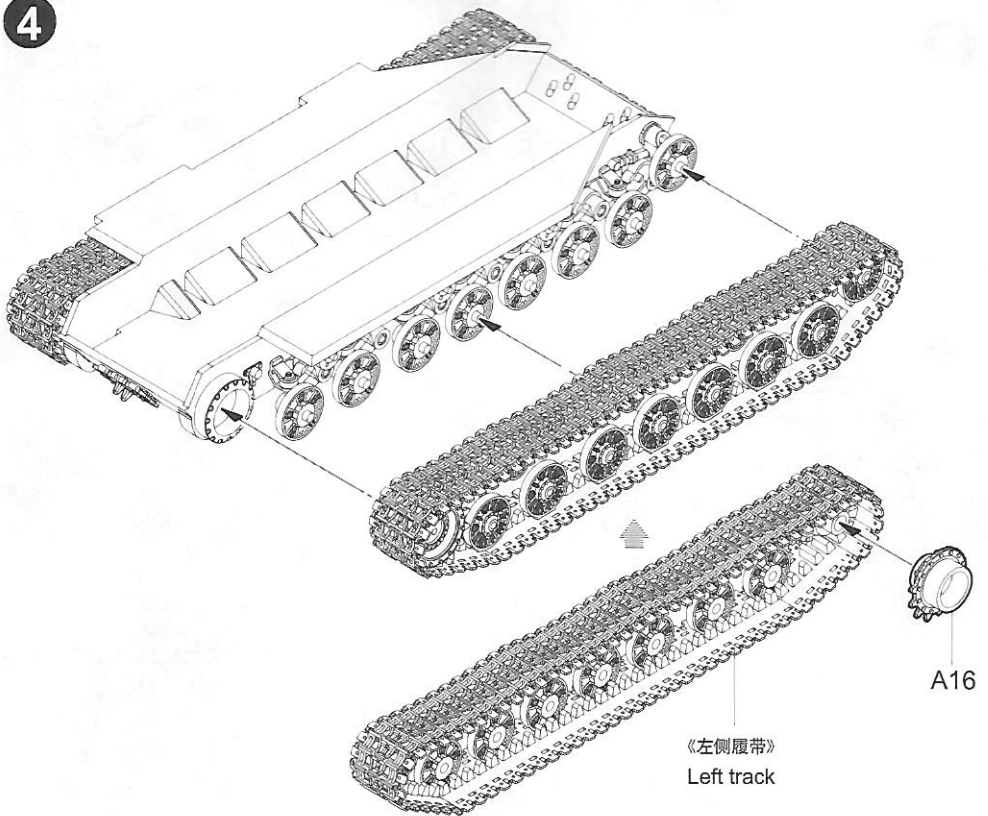

5

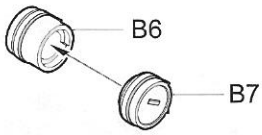

制作2组
Make two

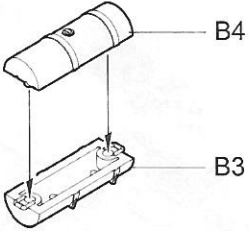
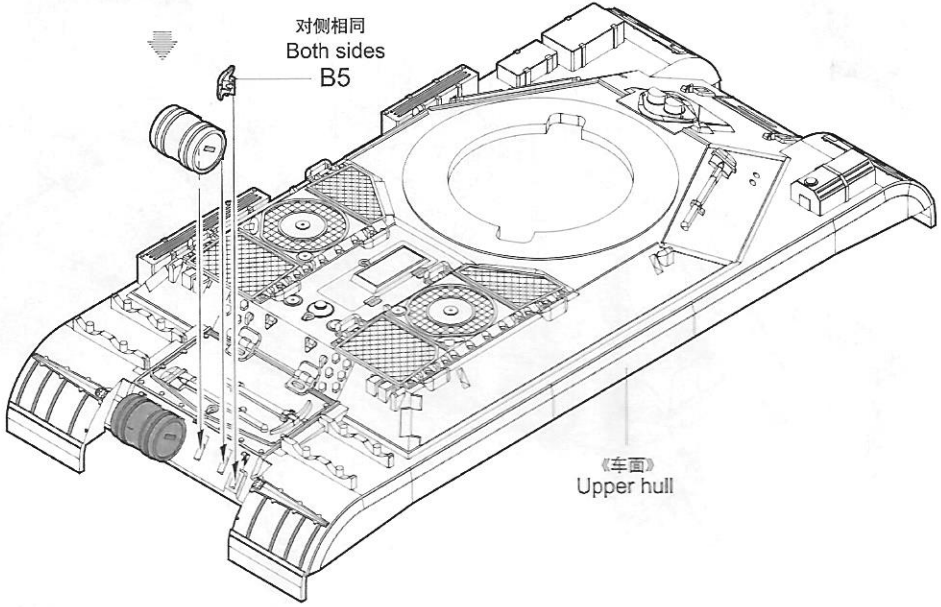

制作4组
Make four

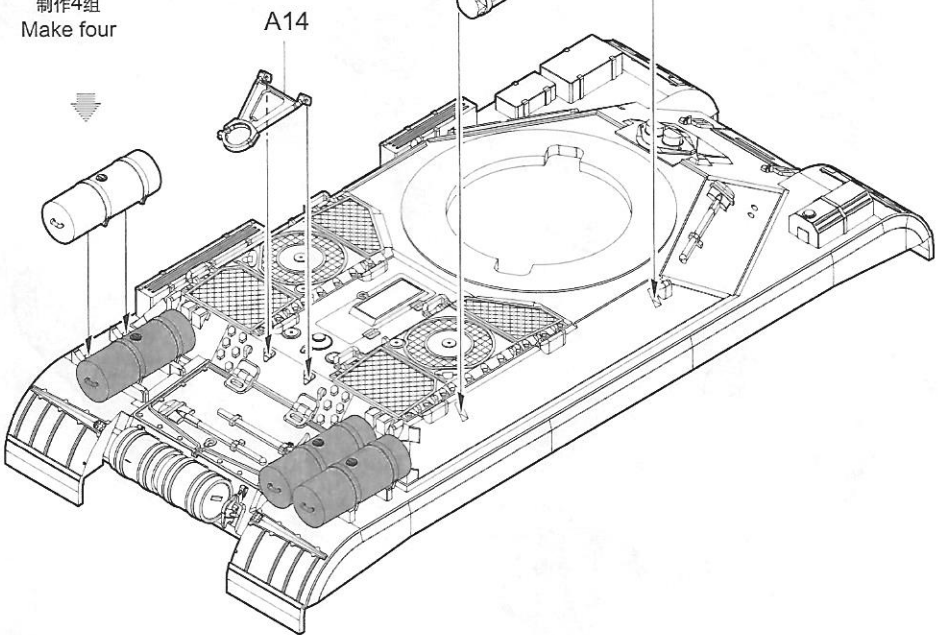

6

对侧相同
Both sides
B10

A8

A7
对侧 A6
Opposite A6

A3

A5

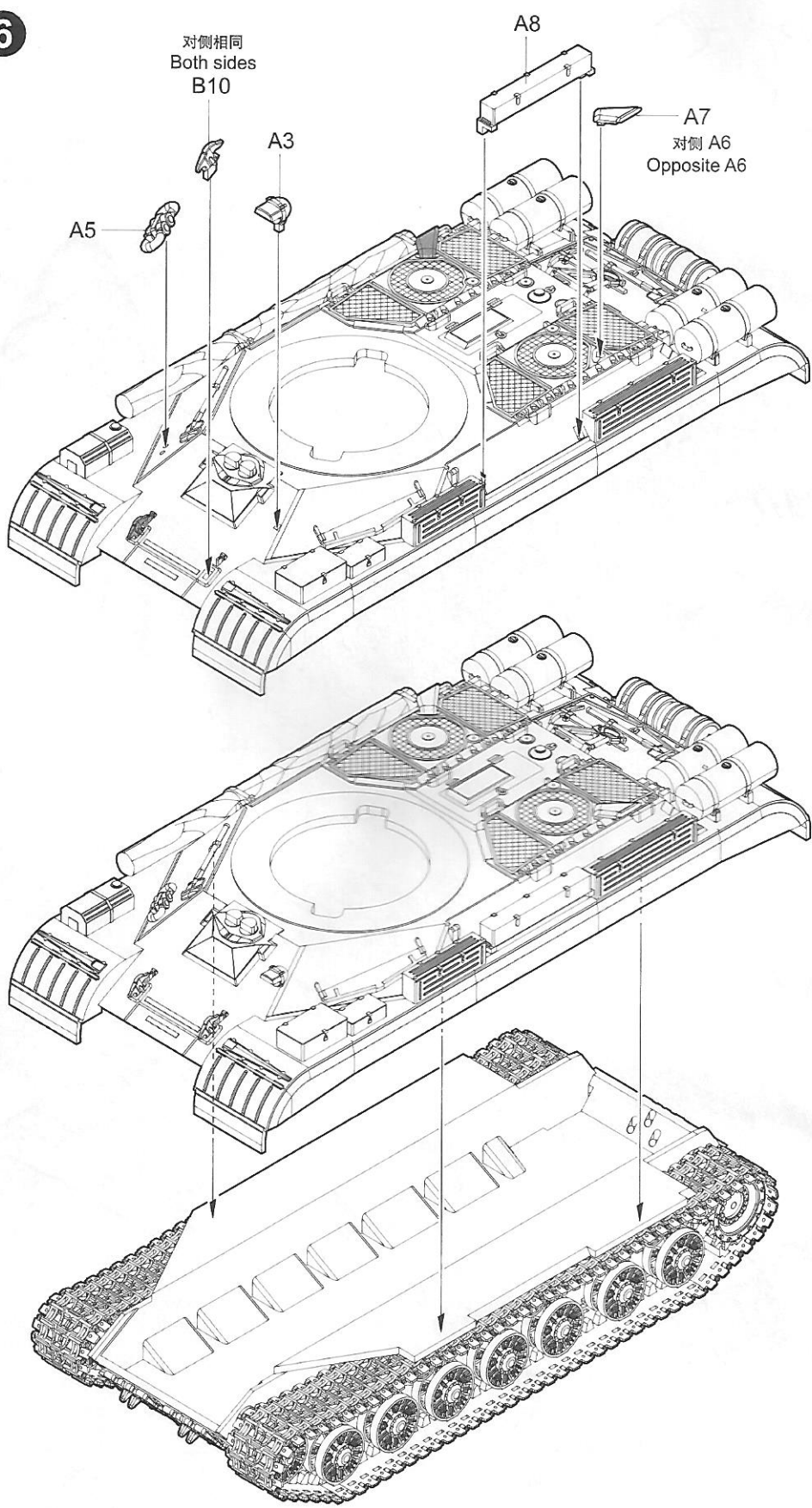

7

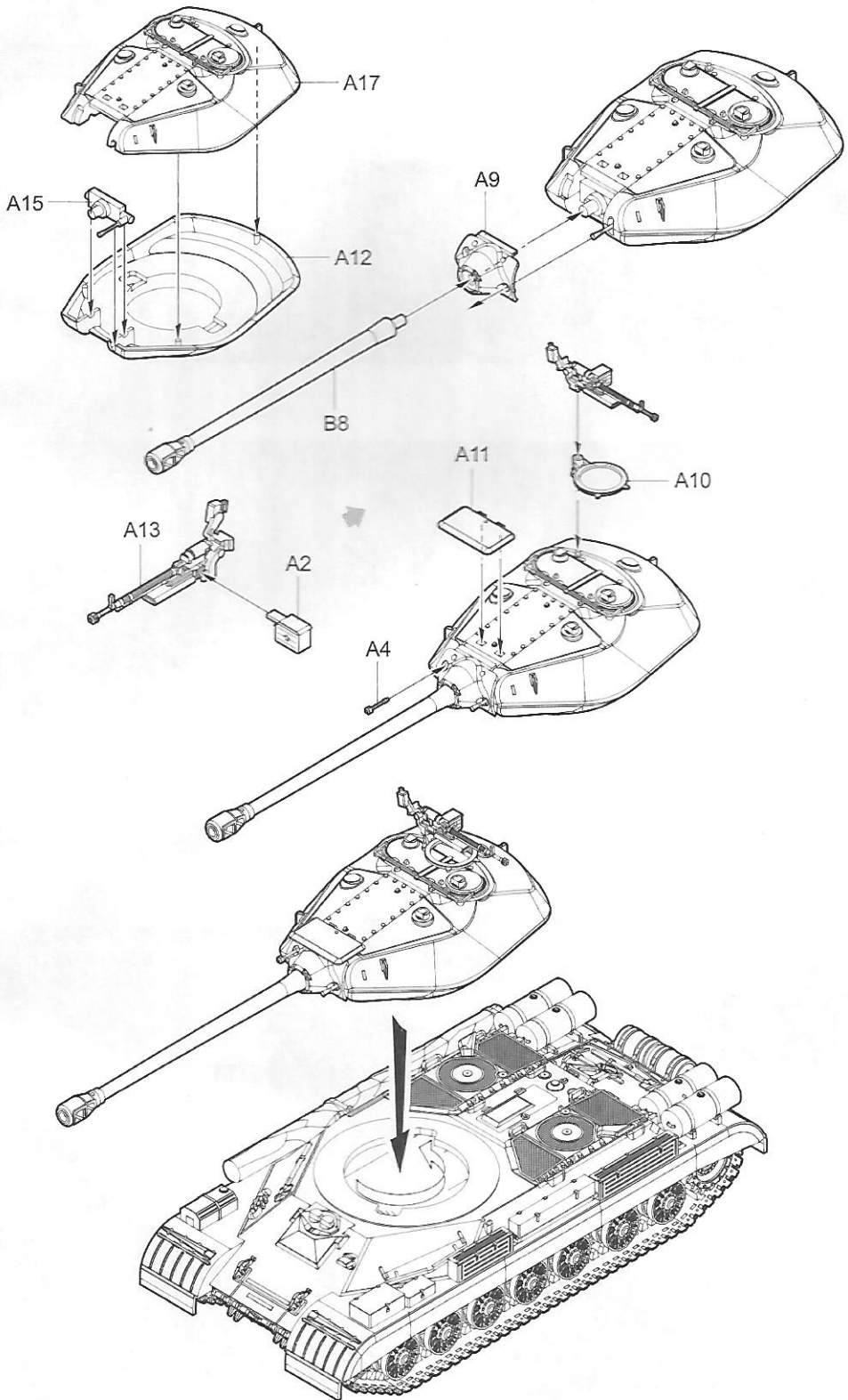

涂装同标贴指示

Painting & Marking guide

PAINT REFERENCE COLOUR

| Color | Mr.Hobby | Vallejo | Model Master | Tamiya | Humbrol |
|--------------------|-----------|---------|--------------|--------|---------|
| Light Green 浅绿色 | H 303 303 | — | 1713 | XF20 | 117 |
| Steel 黑铁色 | H 18 28 | 864 | 1402 | — | — |
| Silver 银色 | H 8 8 | 997 | 1546 | XF11 | 11 |

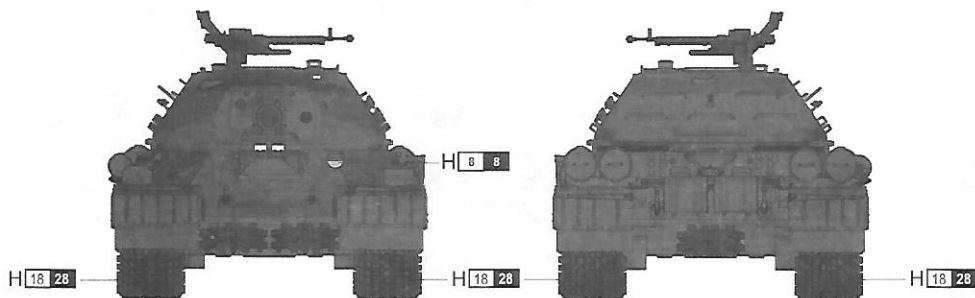
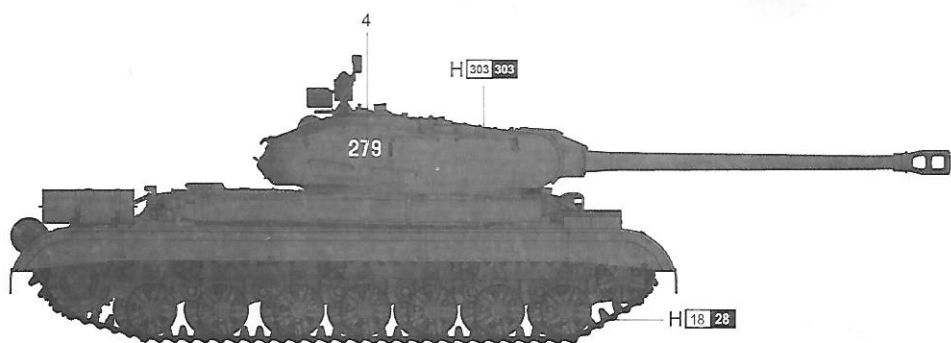
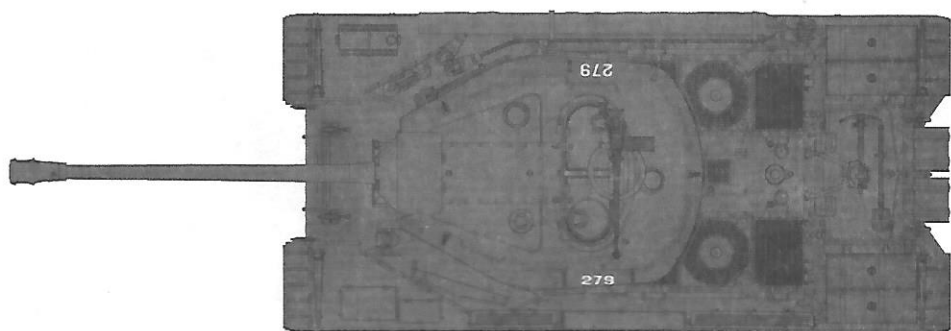
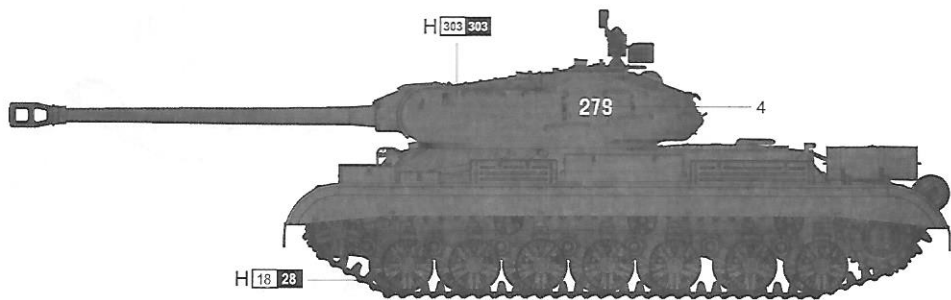

H AQUEOUS HOBBY COLOR Mr. COLOR