

Russian JS-3 with 122mm BL-9

俄罗斯JS-3坦克-122mm BL-9炮管



READ BEFORE ASSEMBLY:

- Study and understand these instructions thoroughly before beginning assembly
- When needed, remove photo-etch parts carefully using a modeling knife or photo etch sprue cutter, being careful not to damage or lose small parts.
- Take extra care in handling photo etch parts in order to avoid injury
- Apply instant cement sparingly to photo etch parts where instructed
- Tools recommended(not included in kit): Plastic and instant cements, sprue cutters, long nose pliers, modeling knife, small files, tweezers, pin vise & scissors. Soft cloth and sandpaper will also assist in construction
- Glue and paint are not included in the kit. Use plastic cement and hobby paints only. Color guide for purchasing paint is included in the kit.

装配之前仔细阅读

- 小心用模型锉刀锉平所有零件表面的注射浇口。
- 小心用刀片切下蚀刻片零件，不要遗失小零件。
- 用强力快干胶水粘合蚀刻片零件和金属轴。过量的快干胶水使用可能导致可动零件会粘住，小心涂胶。
- 取蚀刻片时应特别注意安全，防止利边划伤手指。
- 某些零件表面需贴水上贴纸，请选择在装配的同时进行。
- 推荐模型工具(自备)：胶水，水口剪刀，长咀钳，刀片，锉刀，镊子，钳，钻，剪刀，瞬间快干胶。
- 软布同砂纸同时也应该是必备工具。
- 请使用塑料胶水和油漆，模型内不含。



cyanocrylate glue
使用强力胶



weight
配重



make hole
钻孔



cut / remove
切除



bend
弯曲



file / sand
锉平



option
选择



no cement
不涂胶水



decal
贴纸



先装
Install it first

水贴纸的使用:

1. 从水贴纸上剪下印花;
2. 将印花放入温水中浸10秒, 然后放在干净布上。
3. 拿着印花纸板将印花移到模型上;
4. 手指蘸水将印花移到适当的位置;
5. 用软布轻压印花直至水干, 气泡消失。

DECAL APPLICATION

1. Cut off decal from sheet.
2. Dip the decal in tepid water 40°C for about 10 sec. and place on a clean cloth.
3. Hold the backing sheet edge and slide decal onto the model.
4. Move decal into position by wetting decal with finger.
5. Press decal gently down with a soft cloth until excess water and air bubbles are gone.
6. Allow decal to dry completely before handling model.

部品图
Parts

B

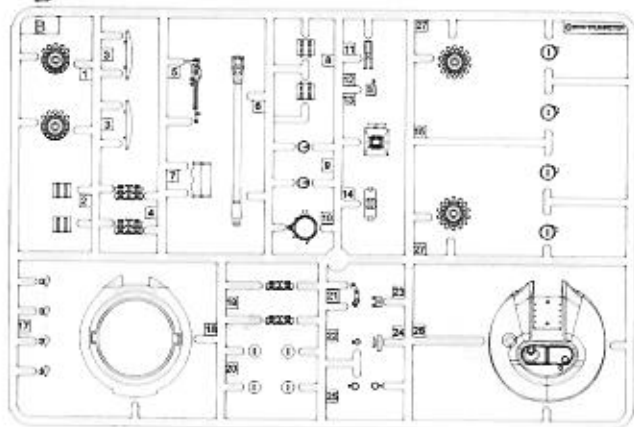

X2



《铜线》 x12
Brass wire x12

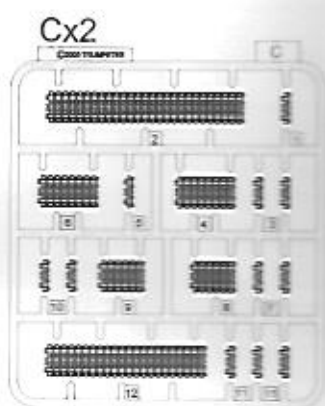
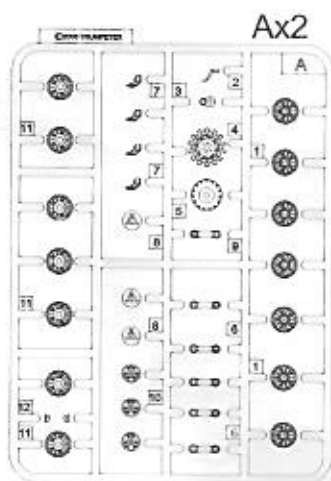

《车面》
Upper hull

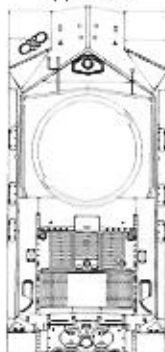

《车底》
Lower hull

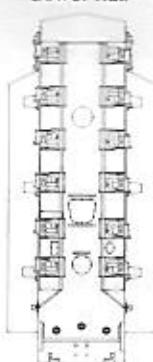

《底座》
Stand

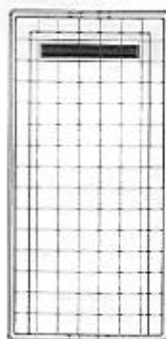

《左侧履带》
Left track



《右侧履带》
Right track



《水贴纸》
Decal



07163 1/72 Russian JS-3 with 122mm BL-9

1

车轮组装 Wheels assembly

?

选择
Option

*参阅第4页车轮组装
Please refer to page 4 for assembly
任选一种车轮组装
Select one two included
wheels for assembly

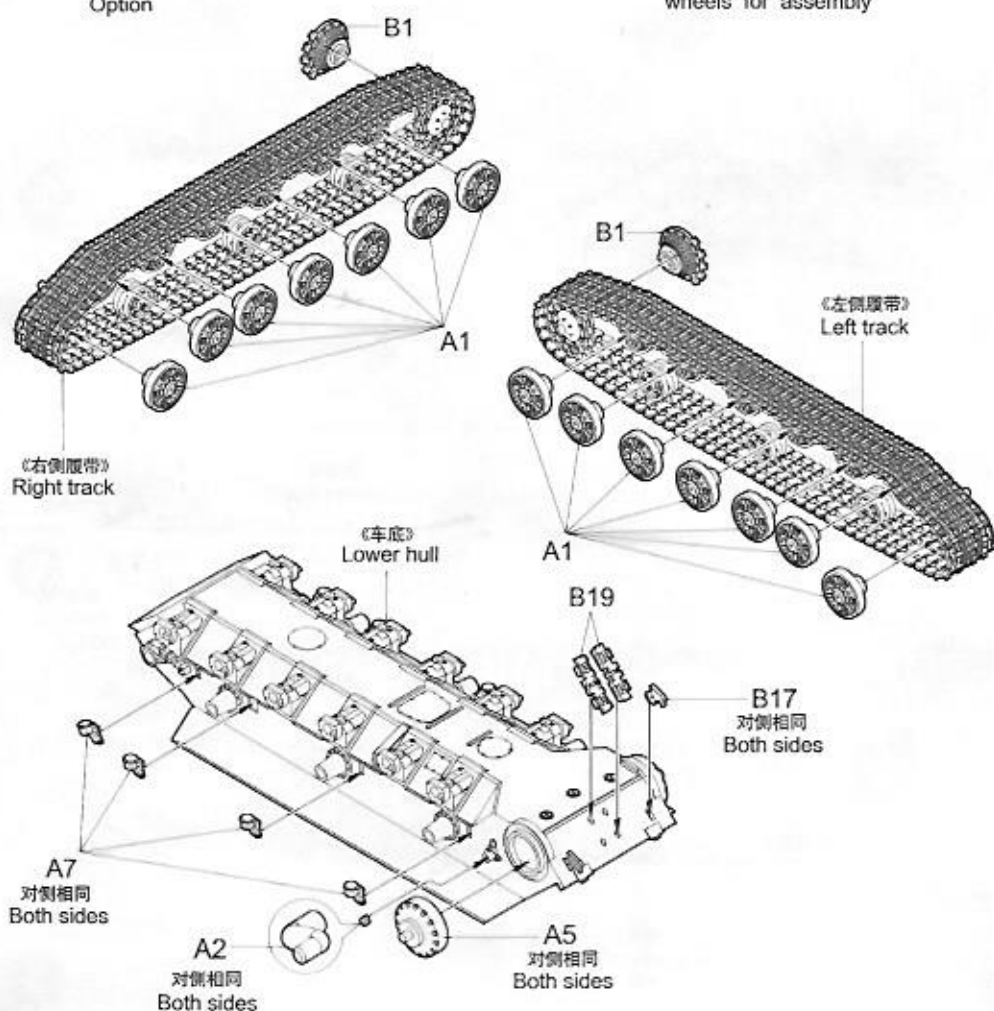
**2**

车轮安装 Attaching wheels

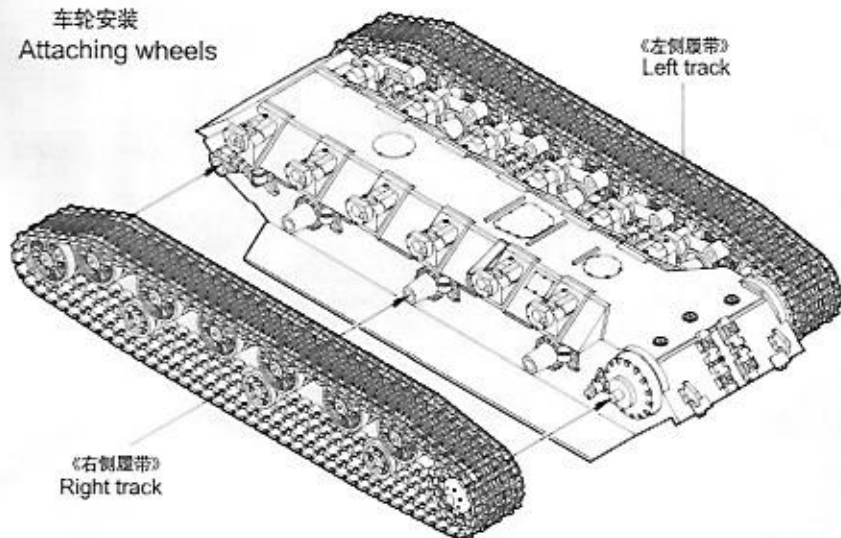

3

车轮安装 Attaching wheels

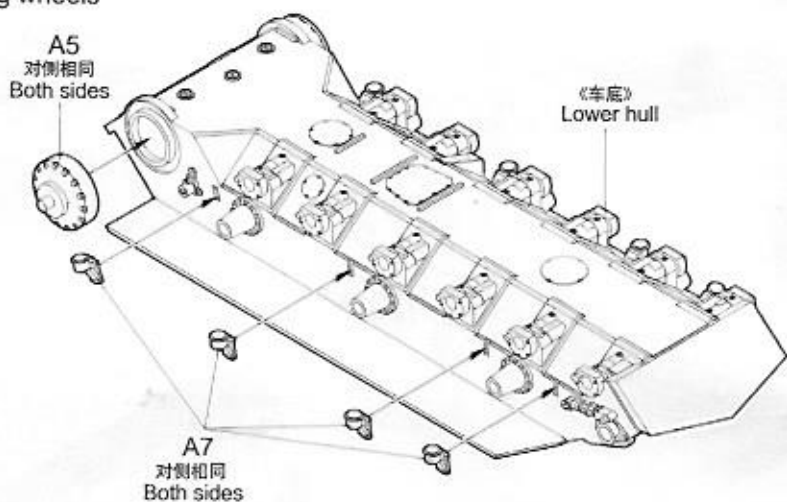

4

车轮安装 Attaching wheels

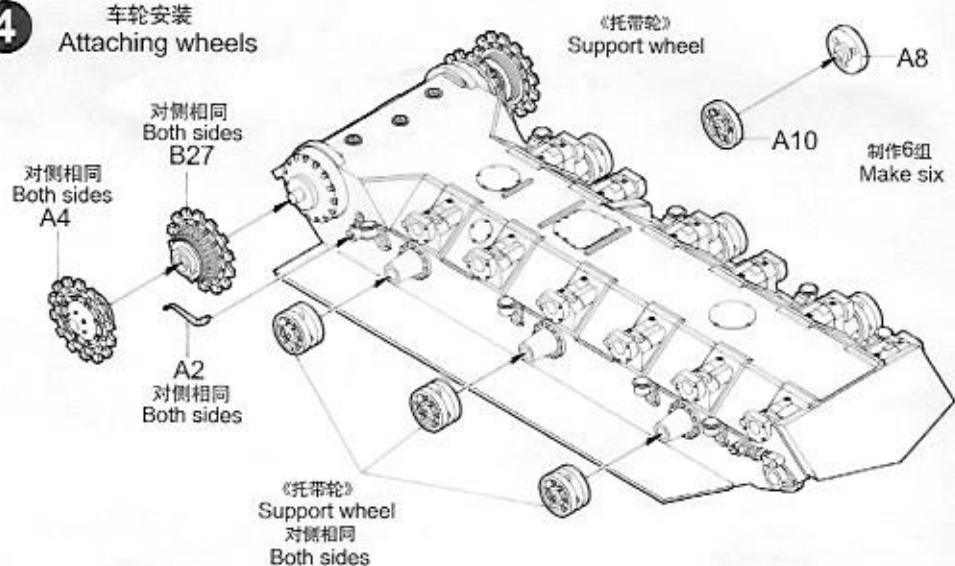

5

车轮安装 Attaching wheels

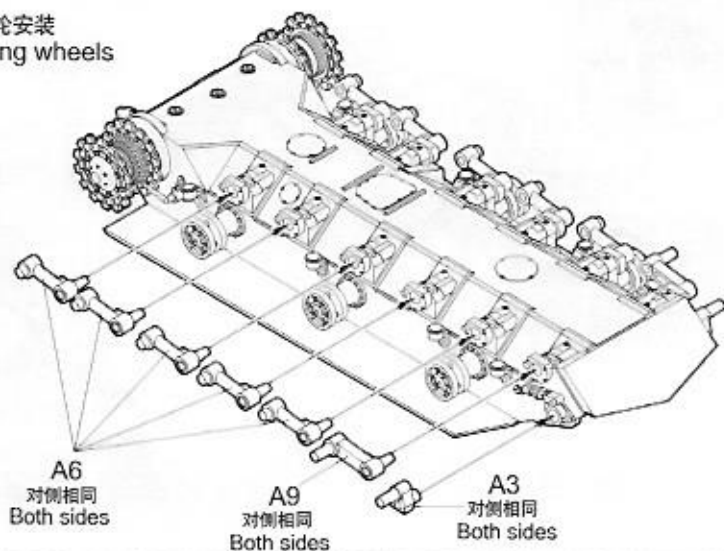

6 车轮安装 Attaching wheels

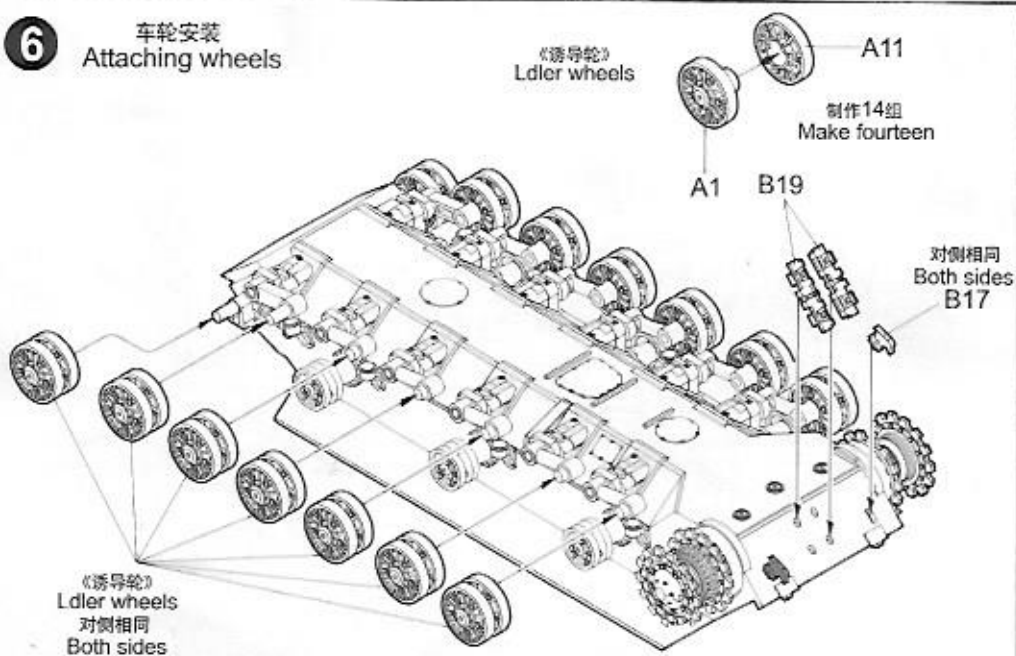

7 履带连接 Track

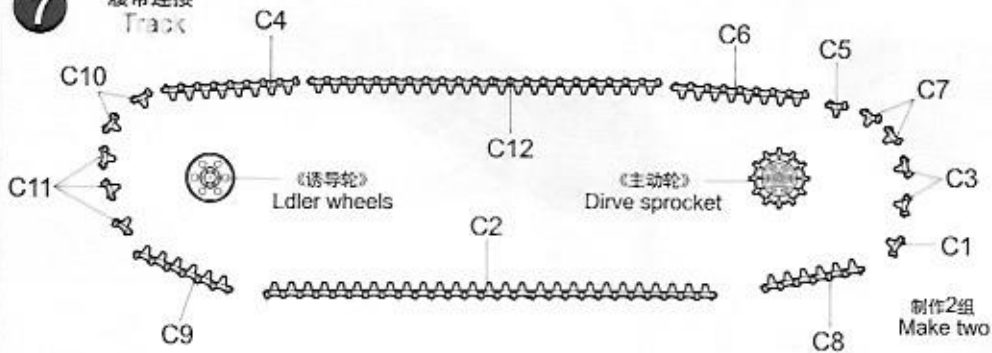

8 车面组装 Upper hull assmebly

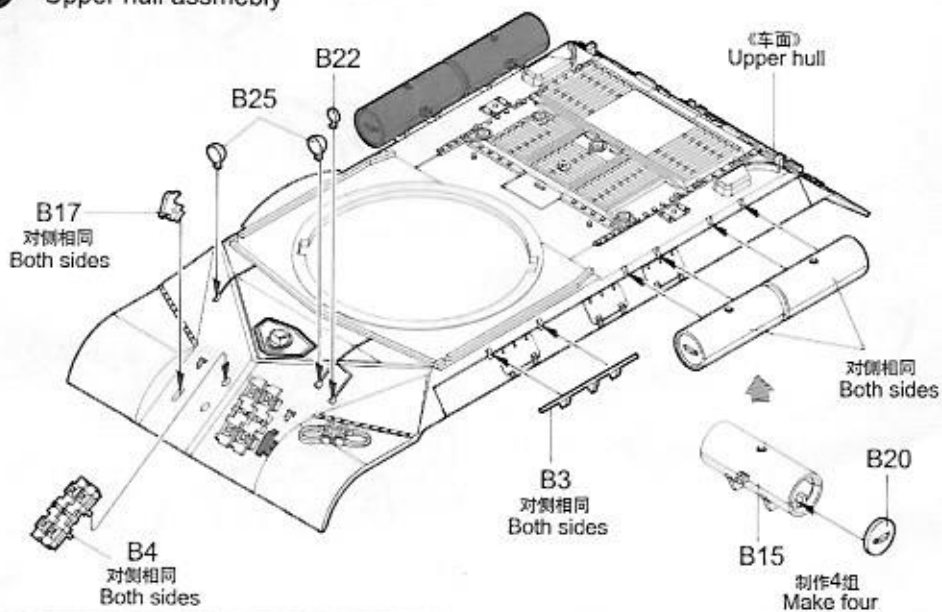

9

车面安装
Attaching upper hull

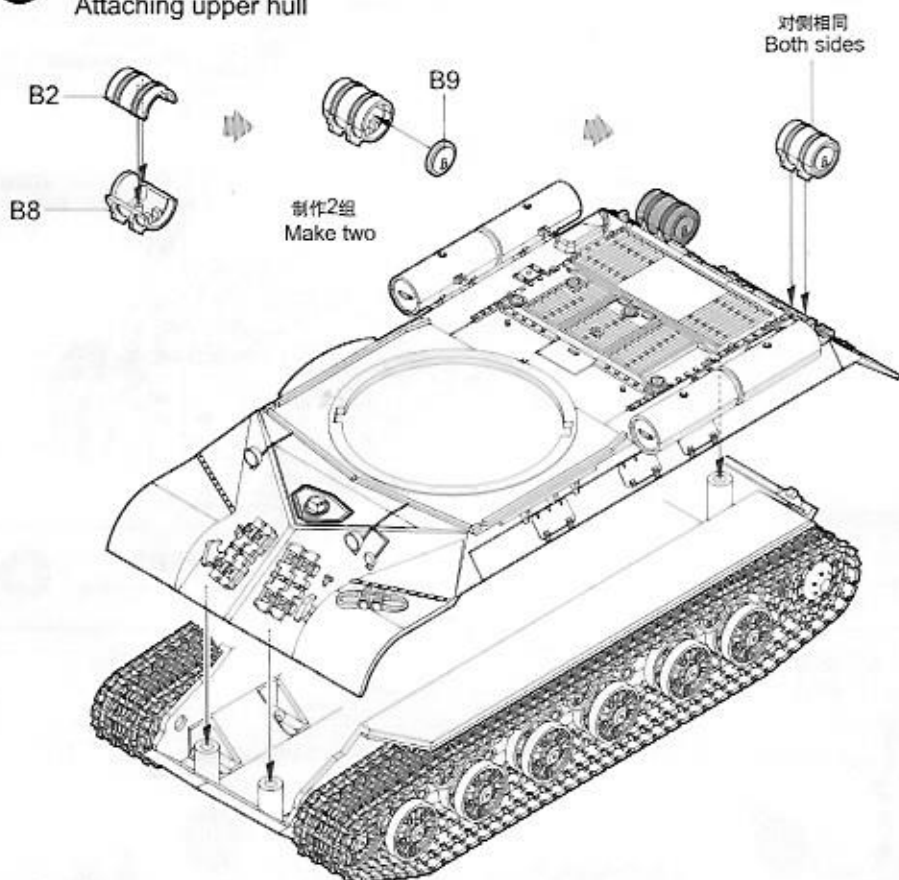

10

炮塔组装
Turret assembly

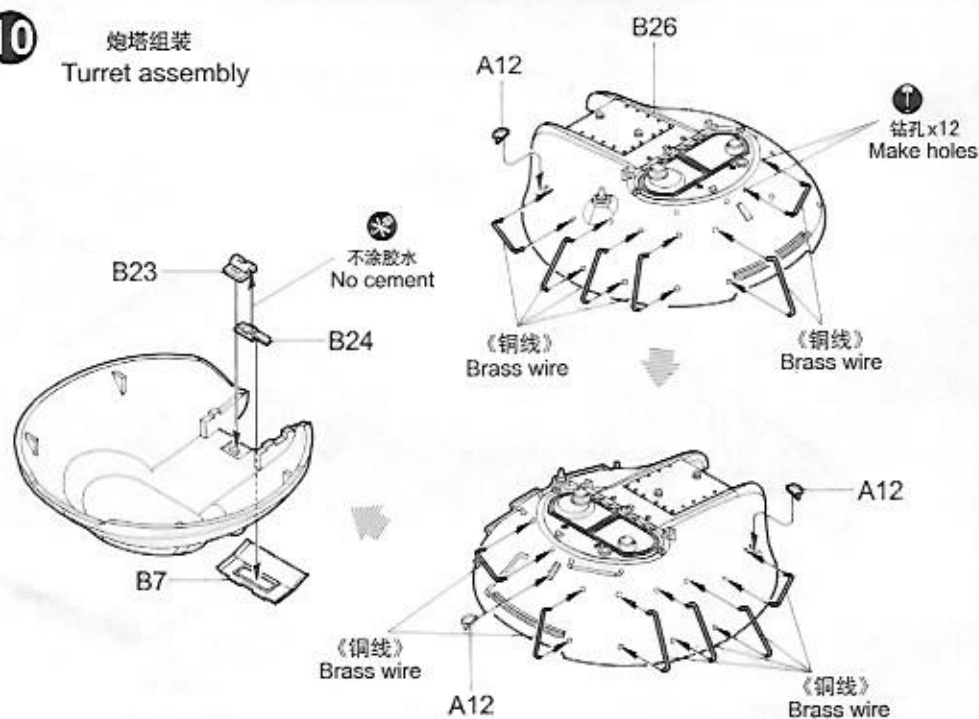

11

主炮组装
Main gun assembly

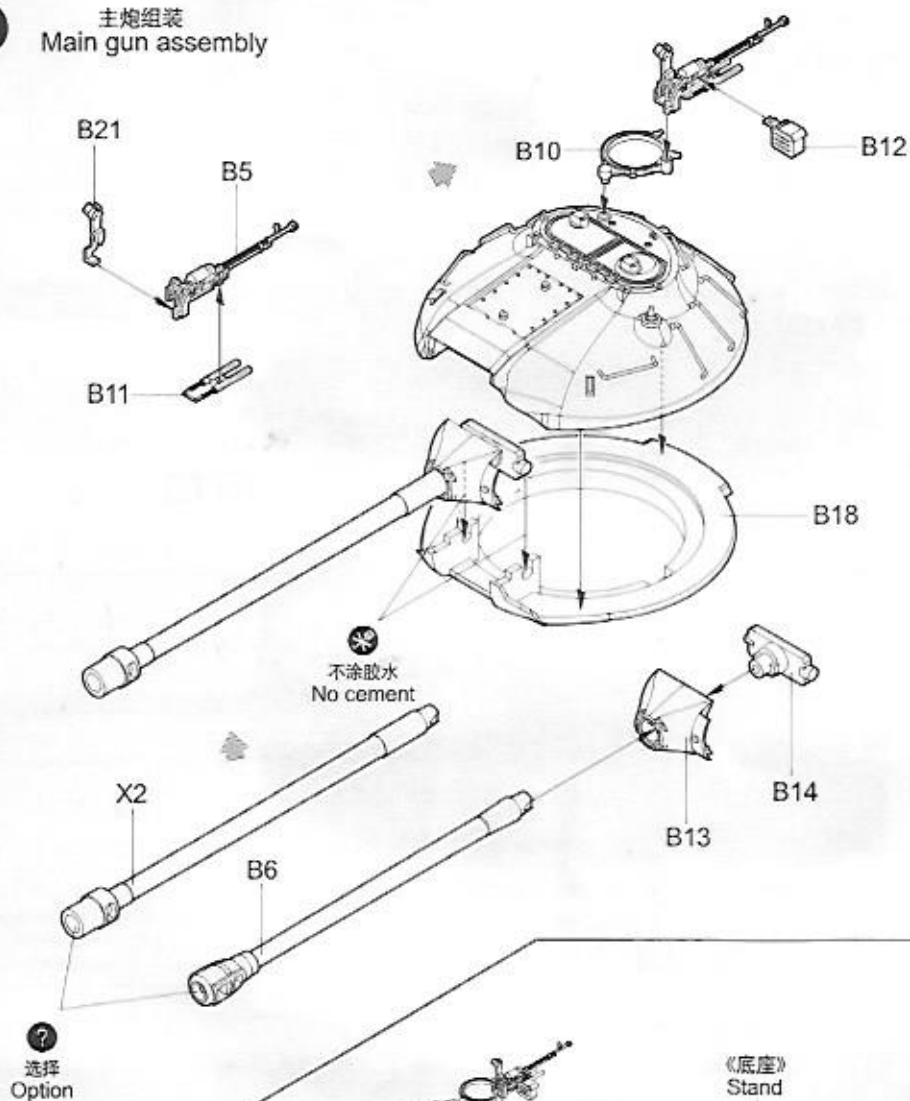

12

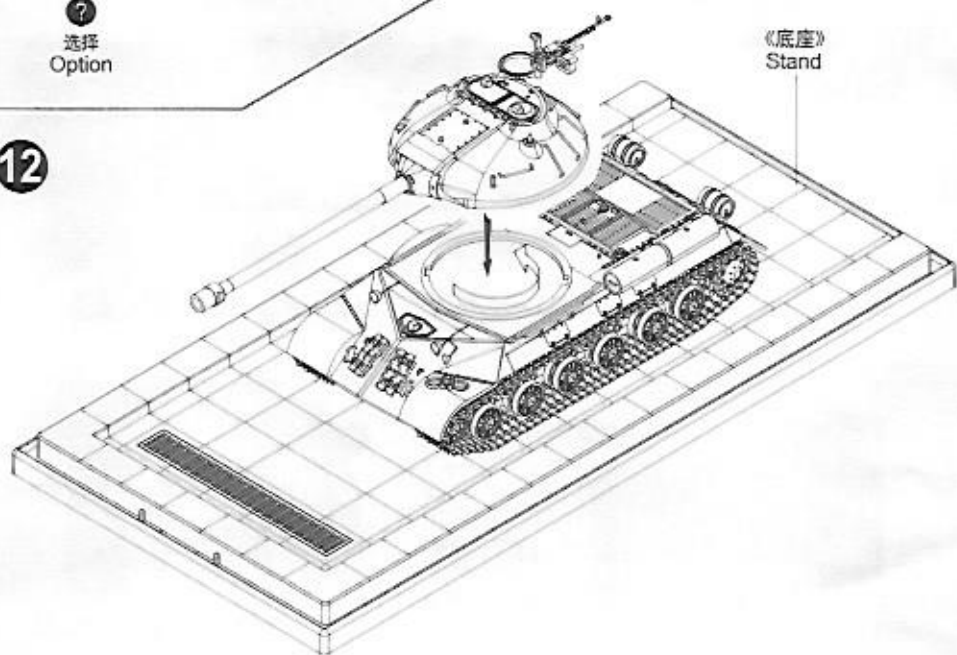

涂装同标贴指示
Painting & Marking guide

PAINT REFERENCE COLOUR

Color	Mr.Hobby	Vallejo	Model Master	Tamiya	Humbrol
Olive Drab(2) (橄榄色)	H 78 38	—	—	—	—
Steel 灰铁色	H 18 28	864	1402	—	—
Silver 银色	H 8 8	997	1546	XF11	11

