

1/350 SCALE

ITEM NO.:05356

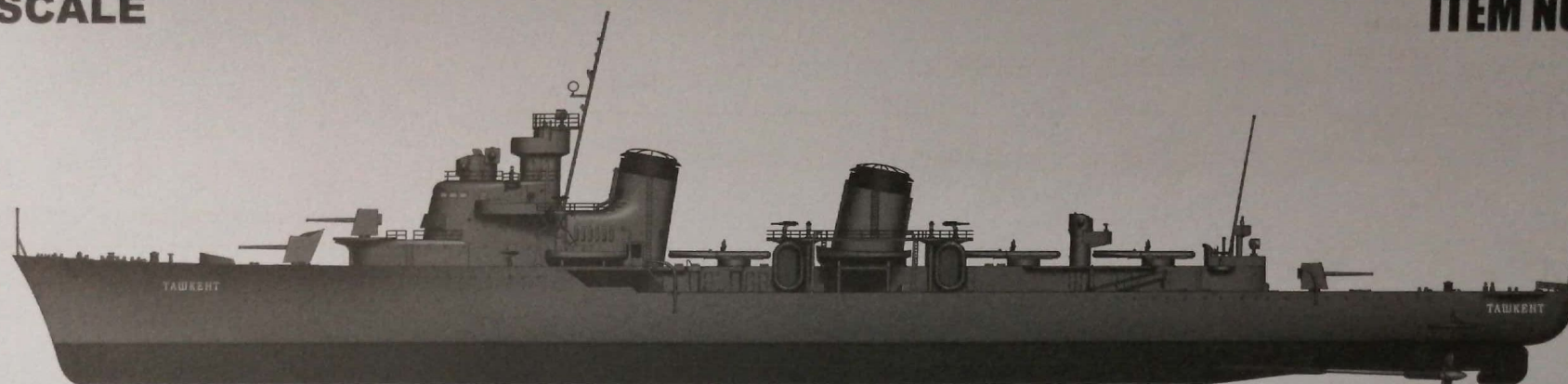

Russian Destroyer Tazkient 1940

俄罗斯“塔什干”驱逐舰1940

READ BEFORE ASSEMBLY:

- This kit is not recommended for inexperienced modelers or for children under 14 years of age
- Study and understand these instructions thoroughly before beginning assembly
- When needed, remove photo-etch parts carefully using a modeling knife or photo etch sprue cutter, being careful not to damage or lose small parts.
- Take extra care in handling photo etch parts in order to avoid injury
- Apply instant cement sparingly to photo etch parts where instructed
- Tools recommended(not included in kit):Plastic and instant cements,sprue cutters,long nose pliers,modeling knife, small files, tweezers, pin vise & scissors. Soft cloth and sandpaper will also assist in construction
- Glue and paint are not included in the kit. Use plastic cement and hobby paints only. Color guide for purchasing paint is included in the kit.
- Keep out of reach of children. They must not be allowed to ingest small parts or handle plastic bags in any way.

装配之前仔细阅读

- 小心用模型锉刀锉平所有零件表面的注射浇口。
- 小心用刀片切下蚀刻片零件，不要遗失小零件。
- 用强力快干胶水粘合蚀刻片零件和金属轴。过量的快干胶水使用可能导致可动零件会粘住，小心涂胶。
- 取蚀刻片时应特别注意安全，防止利边划伤手指。
- 某些零件表面需贴水贴纸，请选择在装配的同时进行。
- 推荐模型工具(自备)：胶水，水口剪刀，长咀钳，刀片，锉刀，镊子钳，钻，剪刀，瞬间快干胶。
- 软布同砂纸同时也应该是必备工具。
- 请使用塑料胶水和油漆，模型内不含。
- 谨防小孩吸吮塑料零件，或者将塑料袋套在头上，制作时应将套材远离小孩接触。
- 本产品不适合14岁以下没有经验的模型爱好者。

水贴纸的使用:

- 1.从水贴上剪下印花;
- 2.将印花放入温水中浸10秒,然后放在干净布上.
- 3.拿着印花纸板将印花移到模型上;
- 4.手指蘸水将印花移到适当的位置;
- 5.用软布轻压印花直至水干, 气泡消失

DECAL APPLICATION

- 1.Cut decals from sheet as needed
- 2.Dip the decal in warm water for about 10 seconds and then place on soft clean cloth.
- 3.Hold the decal backing sheet edge and gently slide the decal onto the model in its proper position.

- 4.While still wet,decal can be adjusted for better fit on model by dampening it gently with your finger.
- 5.When placed in the proper position,gently press decal down with a soft cloth until excess water and air bubbles are gone.
- 6.Allow decal to dry completely before handling model.



配重
Weight



使用强力胶
Cyanoacrylate glue



钻孔
Make hole



切除
Cut / Remove



贴纸
Decal



锉平
File / Sand



选择
Option



不涂胶水
No cement



弯曲
Bend



先装
Install it first

部品图 Parts

《船体》
Hull

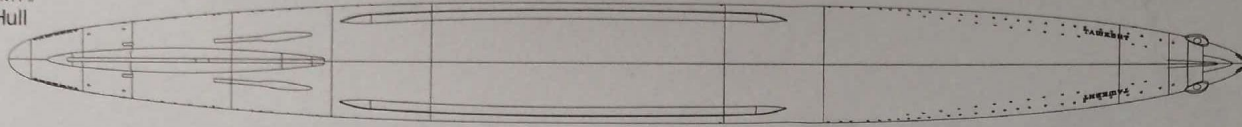

《前甲板》
Front Deck

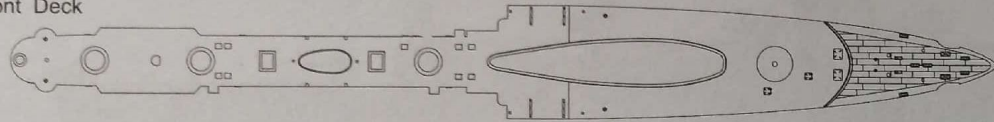

《后甲板》
Rear Deck

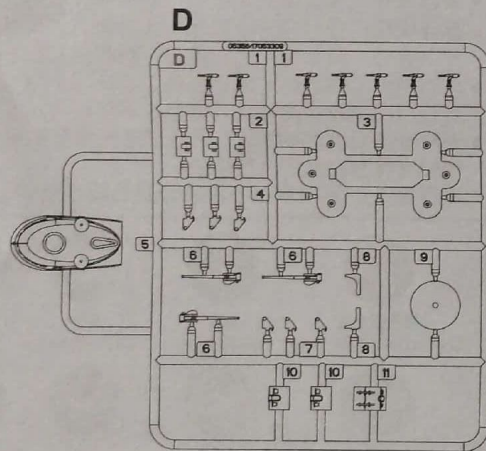
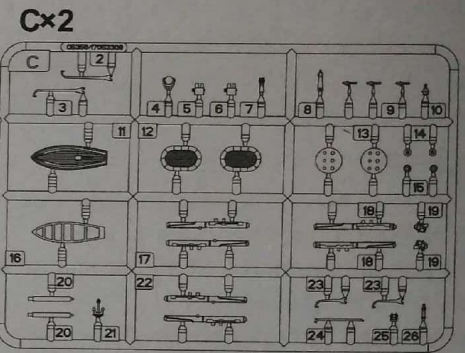
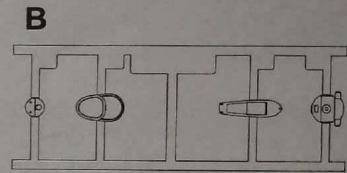
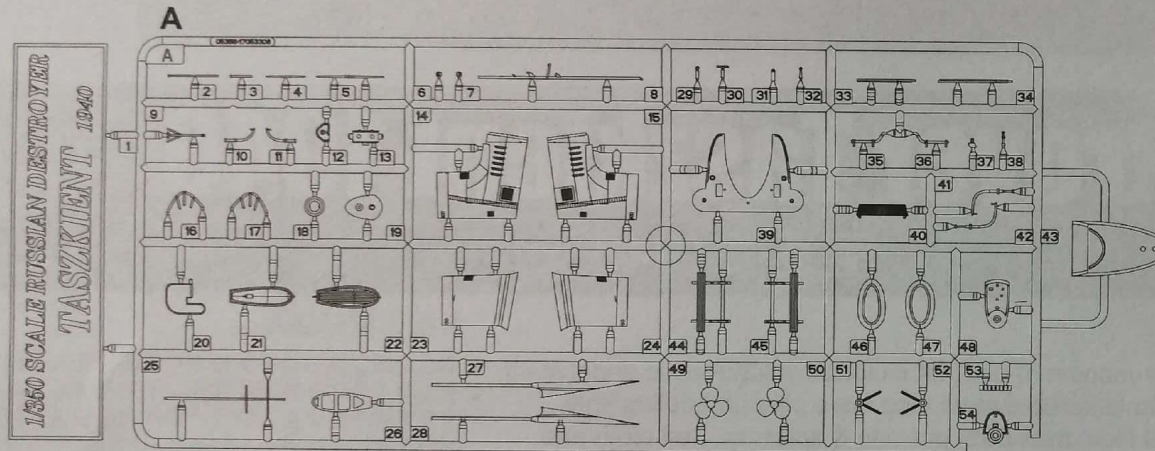
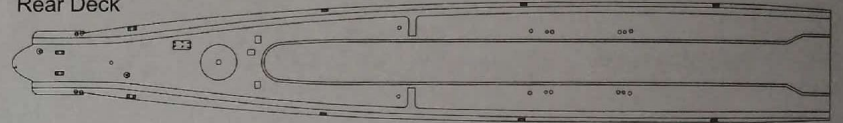

座架
Stand

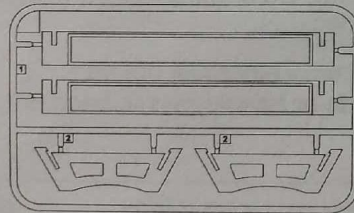

《蚀刻片》
Photo Etched

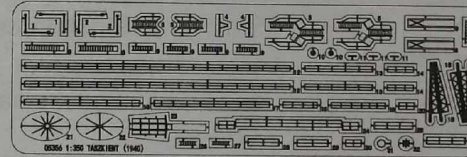

《贴纸》
Decal



1

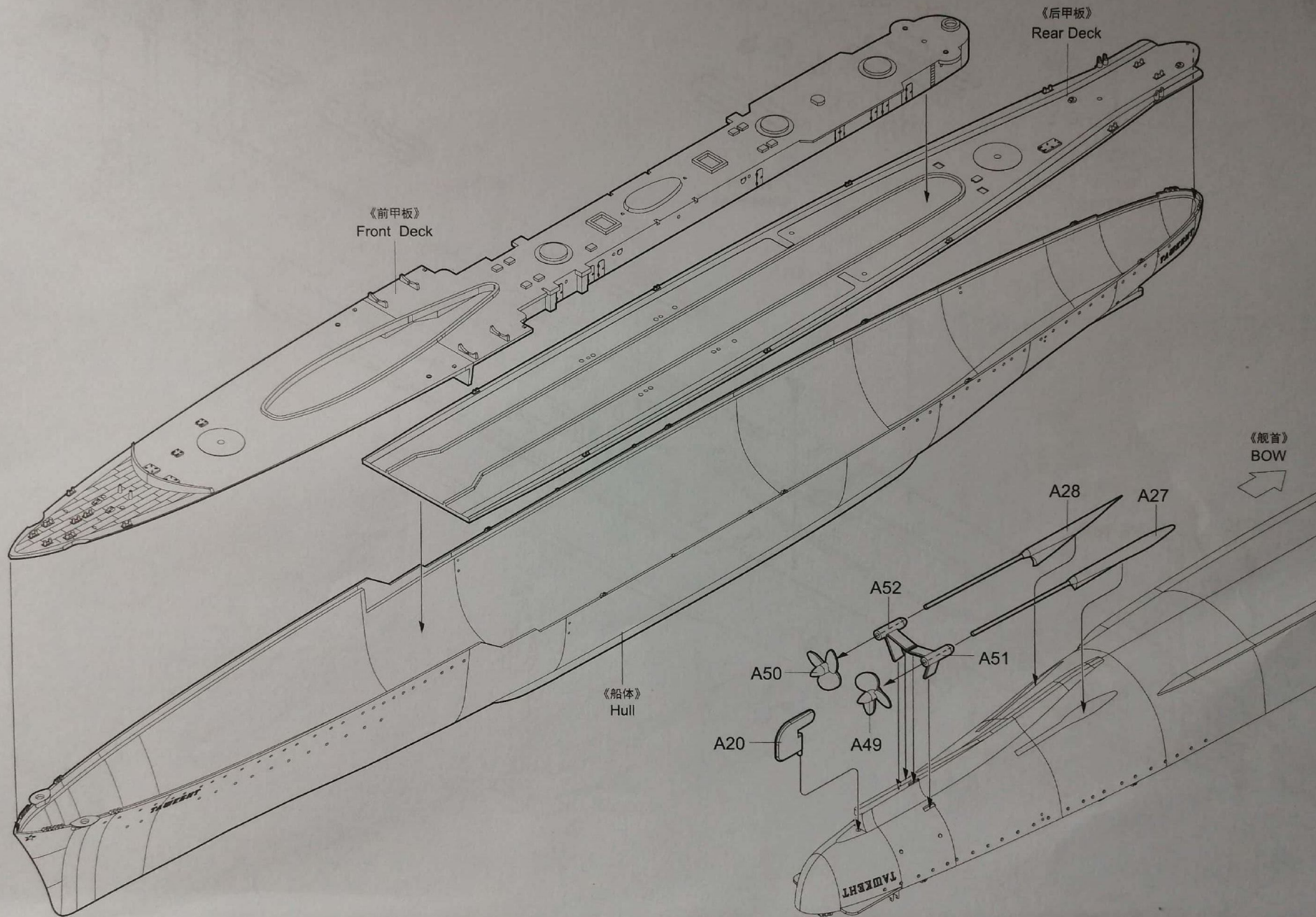

2

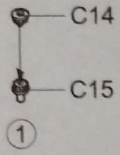

制作3组
Make three

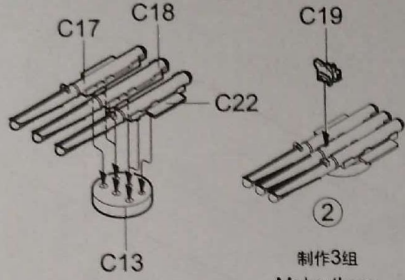

制作3组
Make three

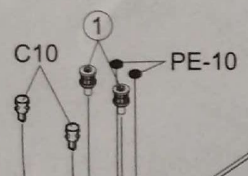
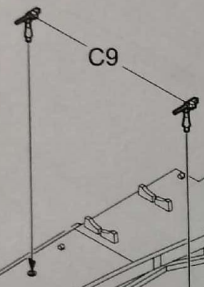
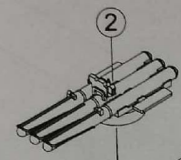
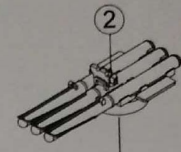
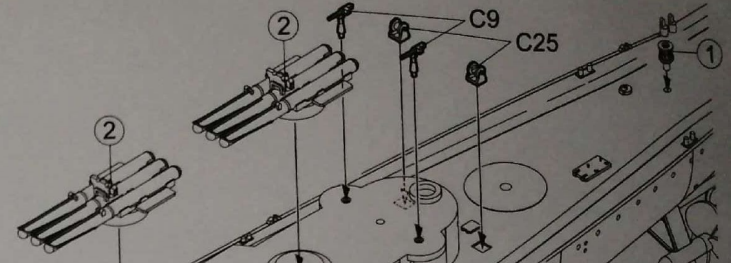

《舰首》
BOW

对侧相同
C21 Both sides

3

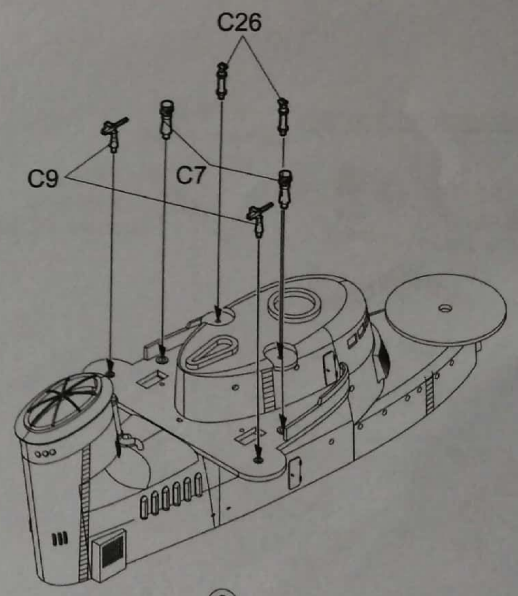
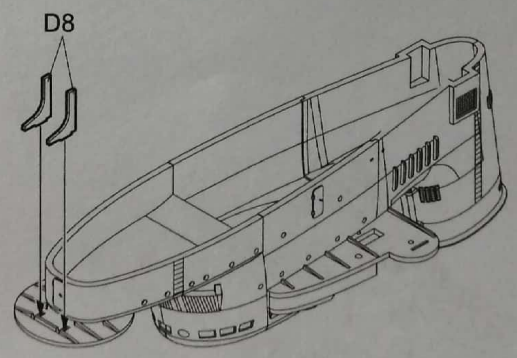
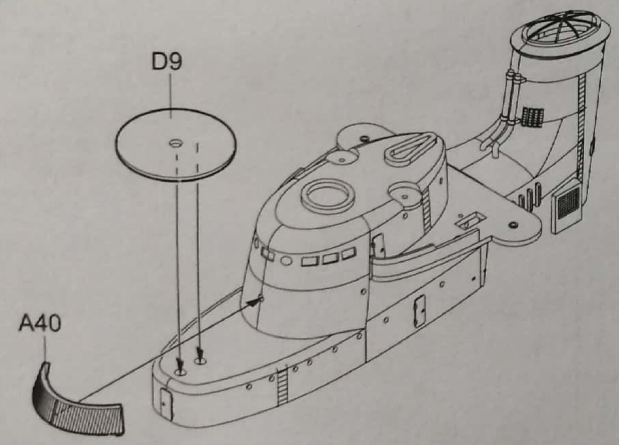
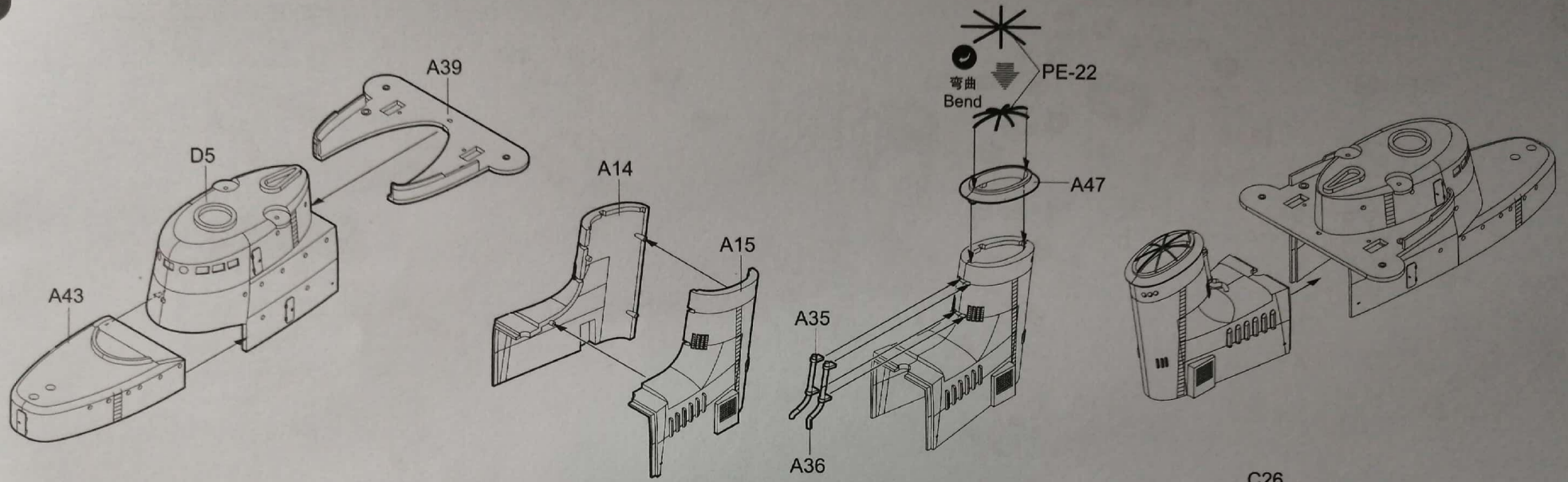

3

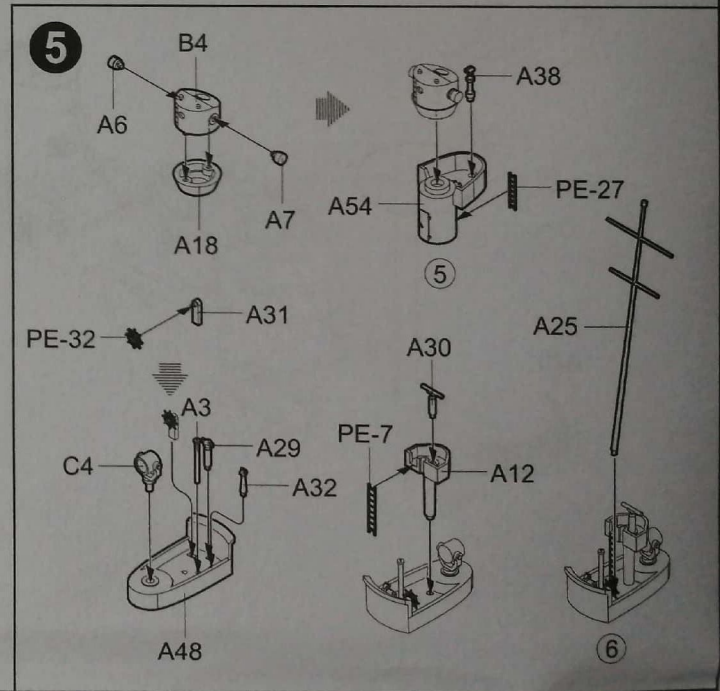
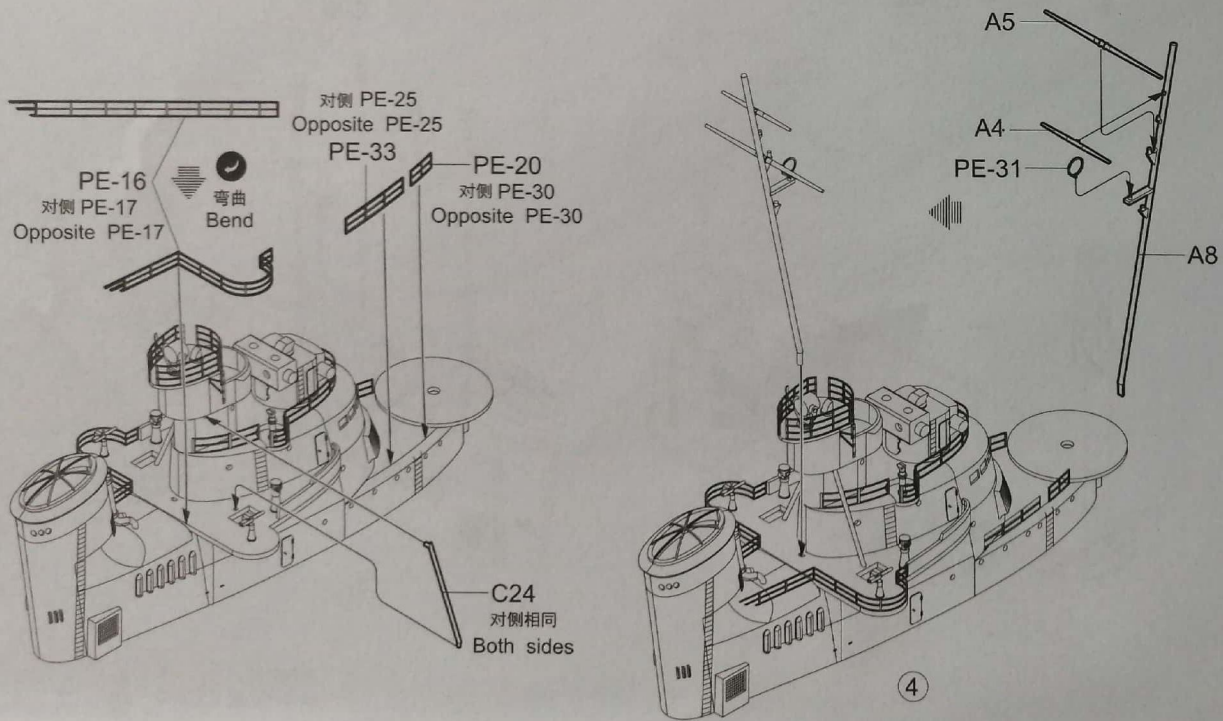
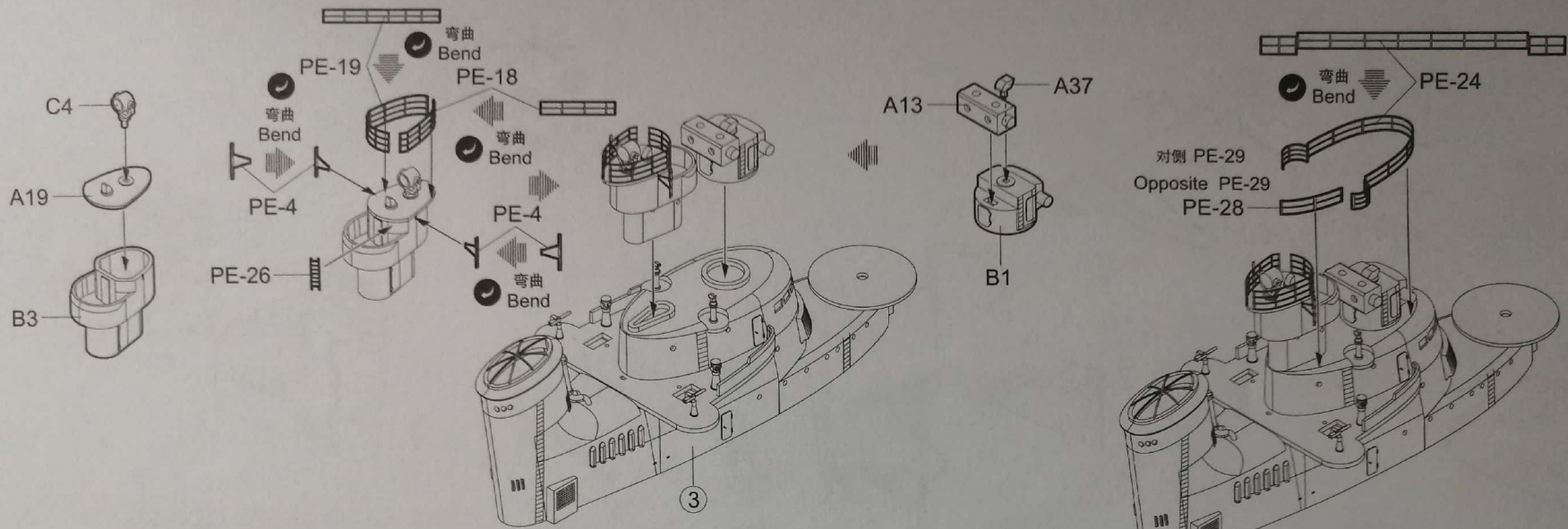

6

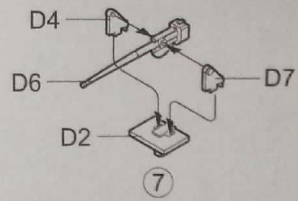

制作3组
Make three

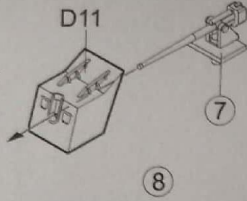

8

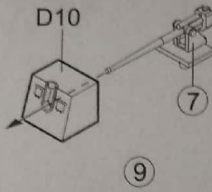

9

制作2组
Make two

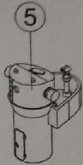
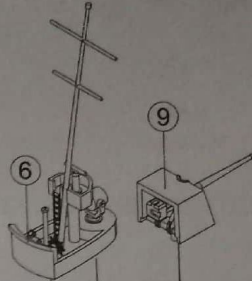
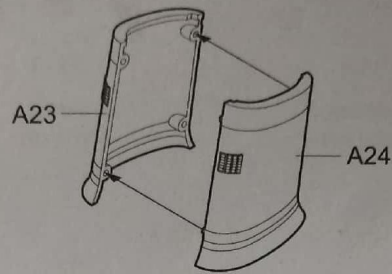

A33

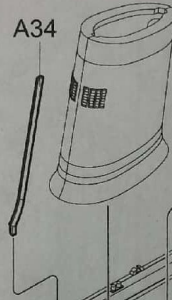

A34

4

9

8

《舰首》
BOW



7

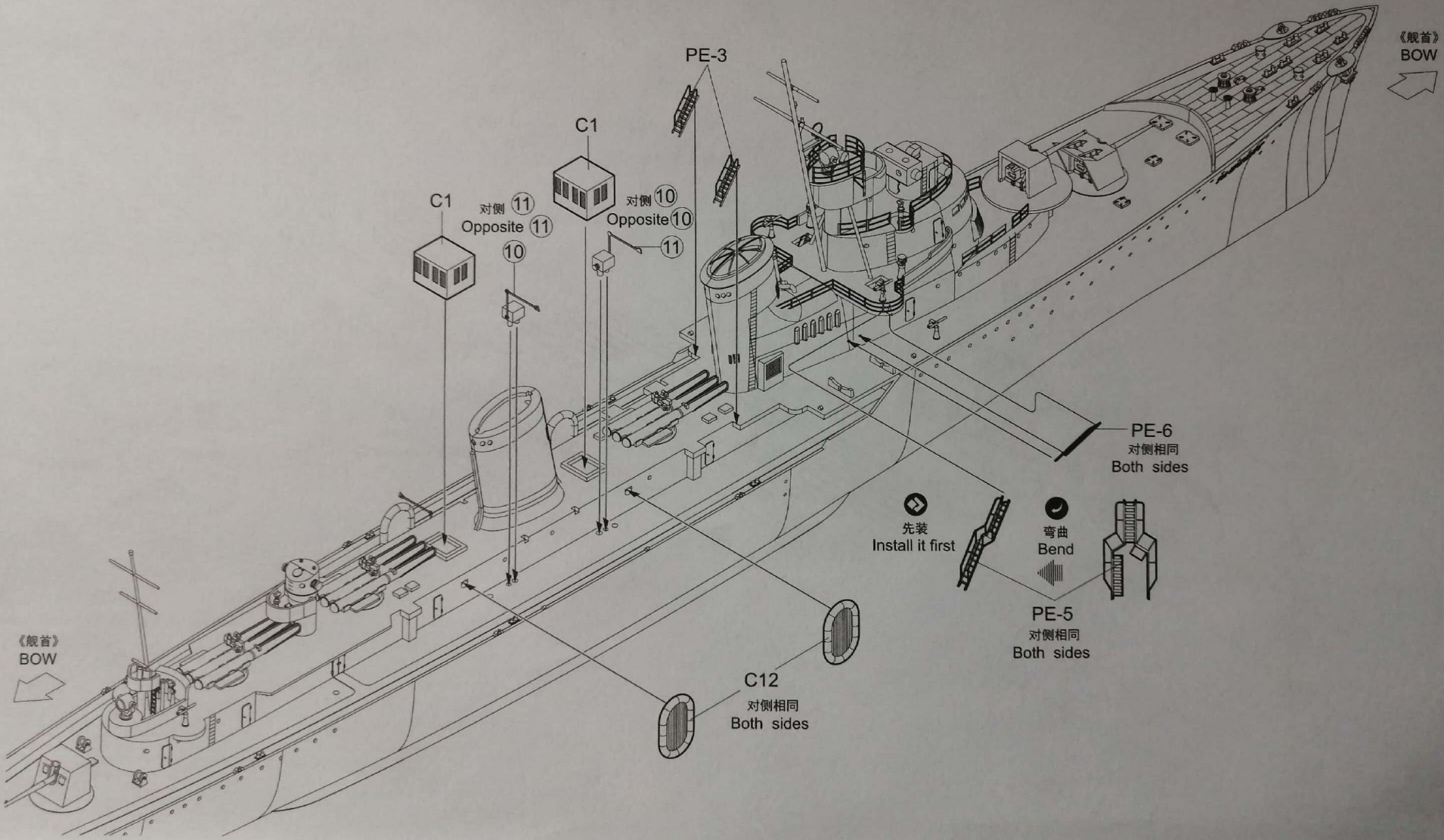
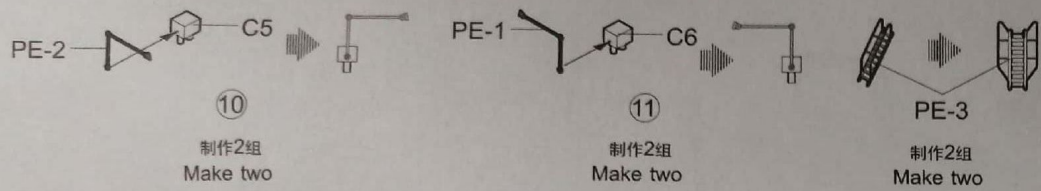

8

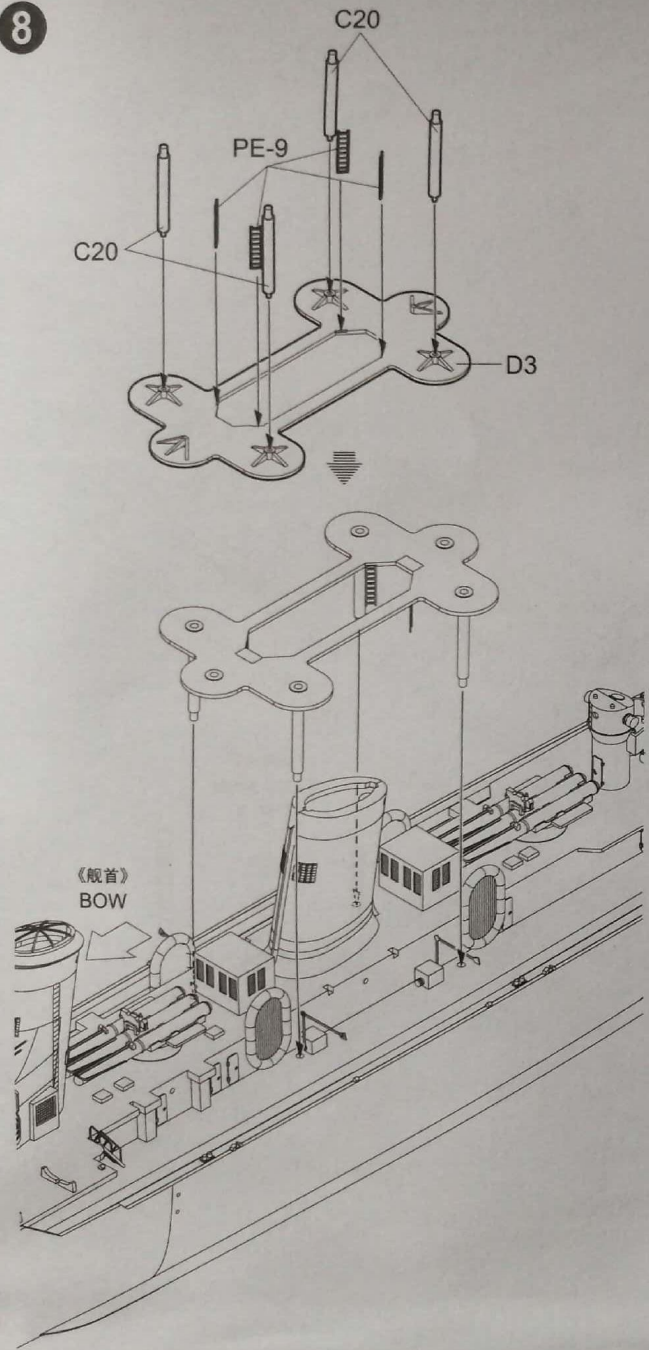

9

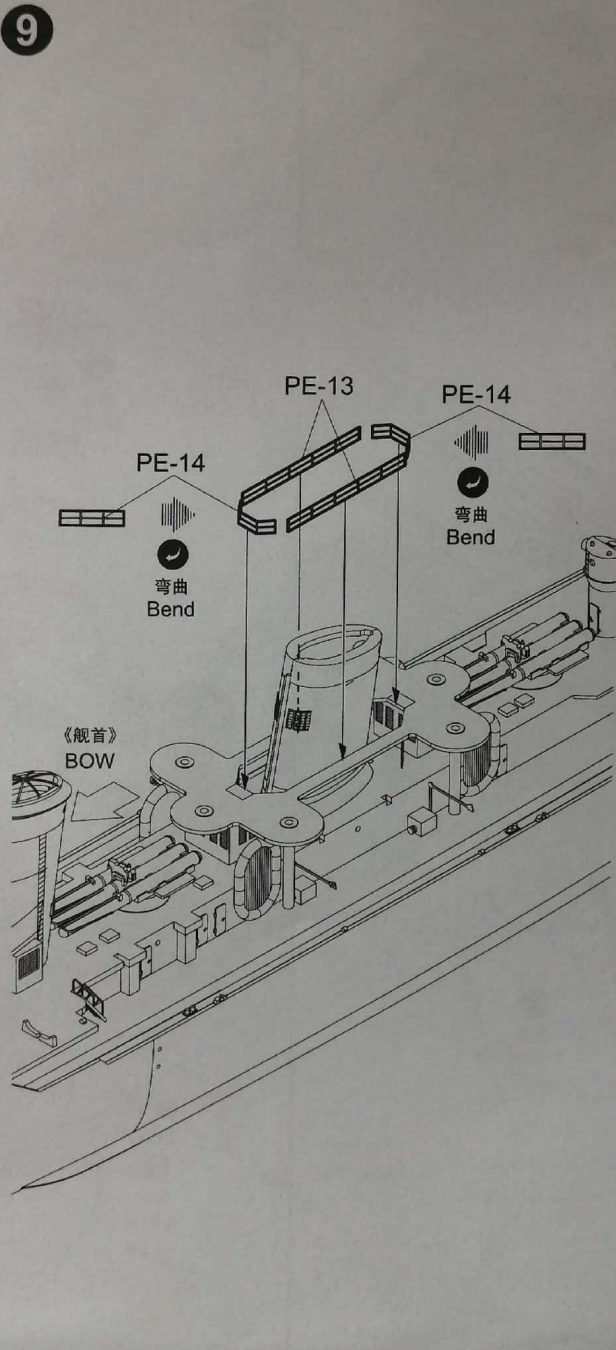

10

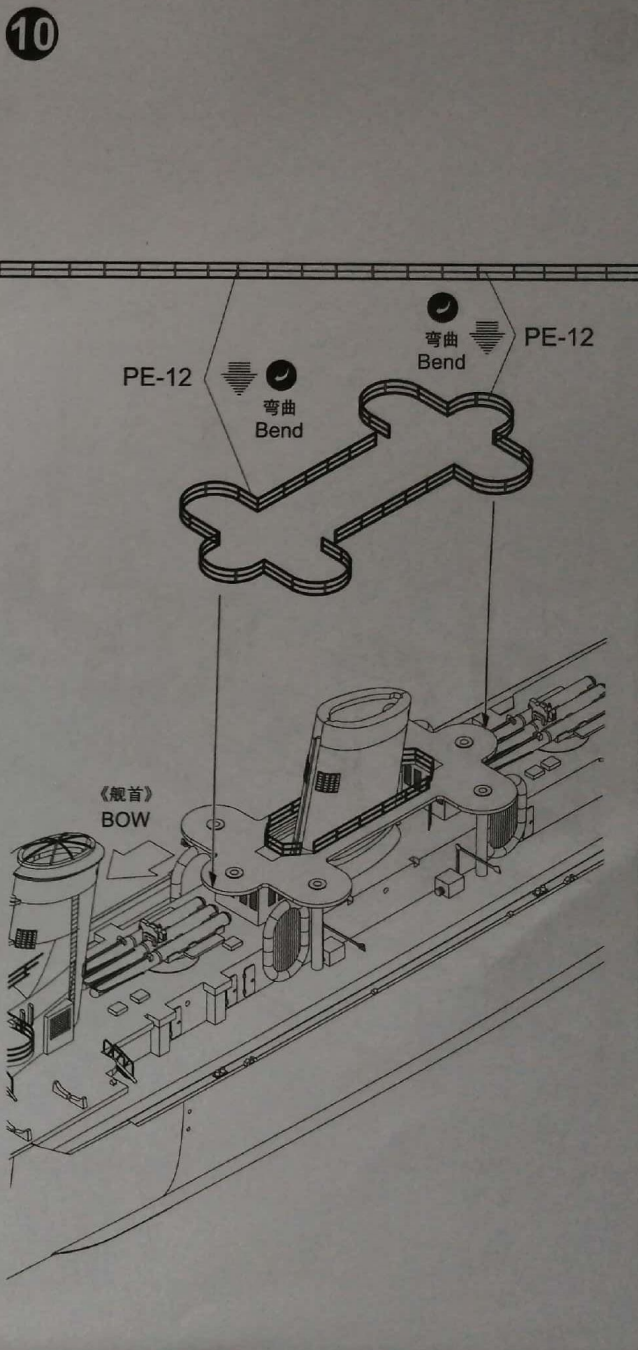

11

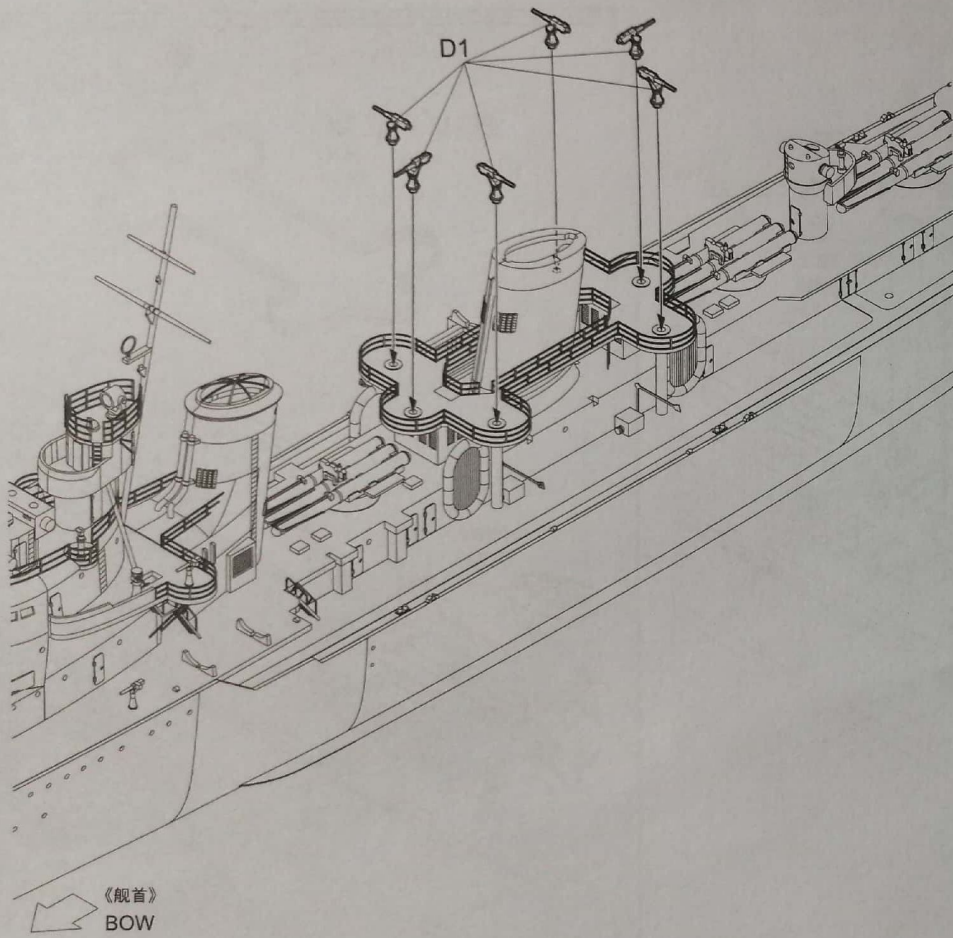

12

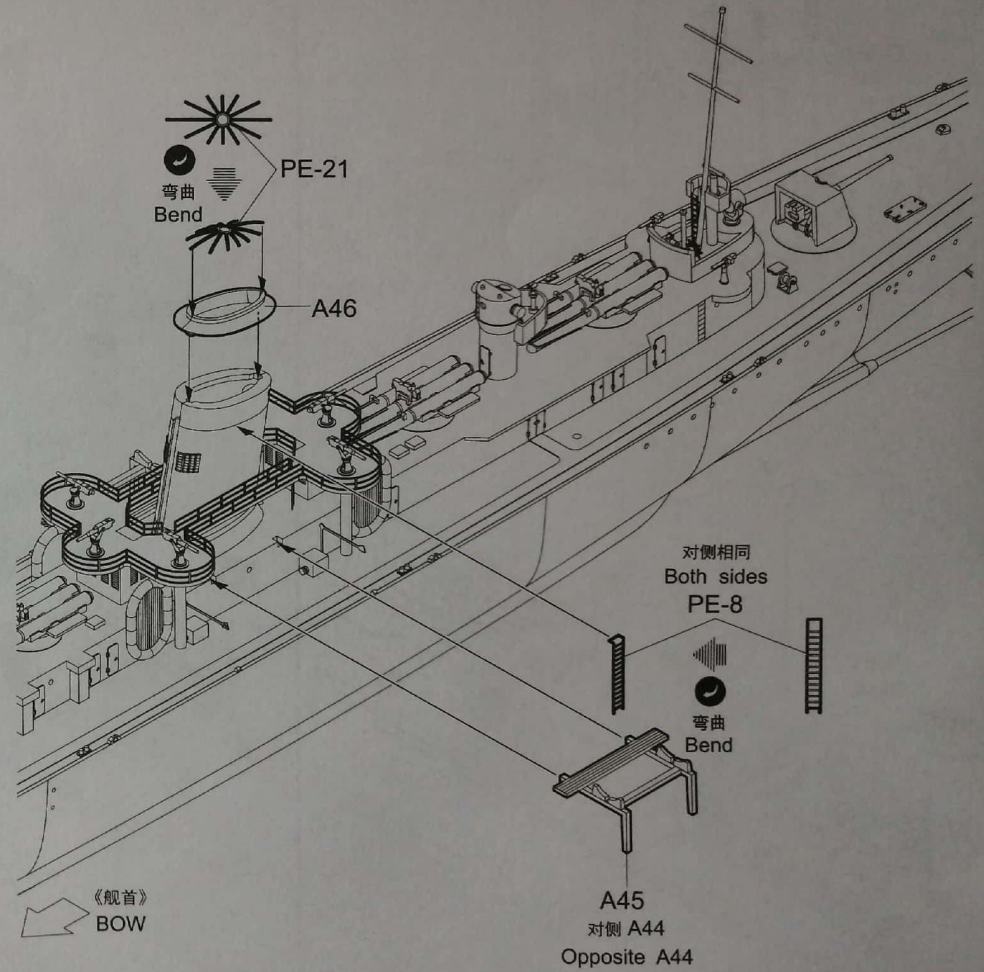

13

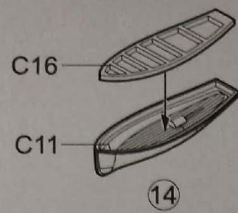
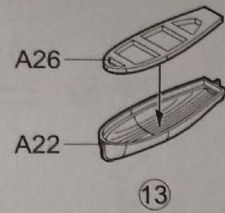
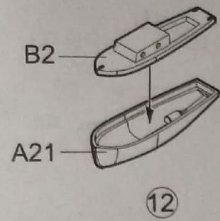

制作2组
Make two

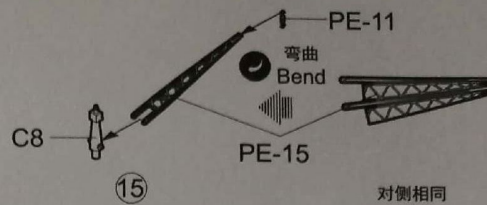

制作2组
Make two

对侧相同
Both sides

⑮

对侧相同
Both sides

⑭

对侧
Opposite ⑬

⑫

《舰首》
BOW



C3 对侧 C2
Opposite C2

选择
Option

选择
Option

选择
Option

C2
对侧 C3
Opposite C3

C23
对侧相同
Both sides

选择
Option

C23
对侧相同
Both sides

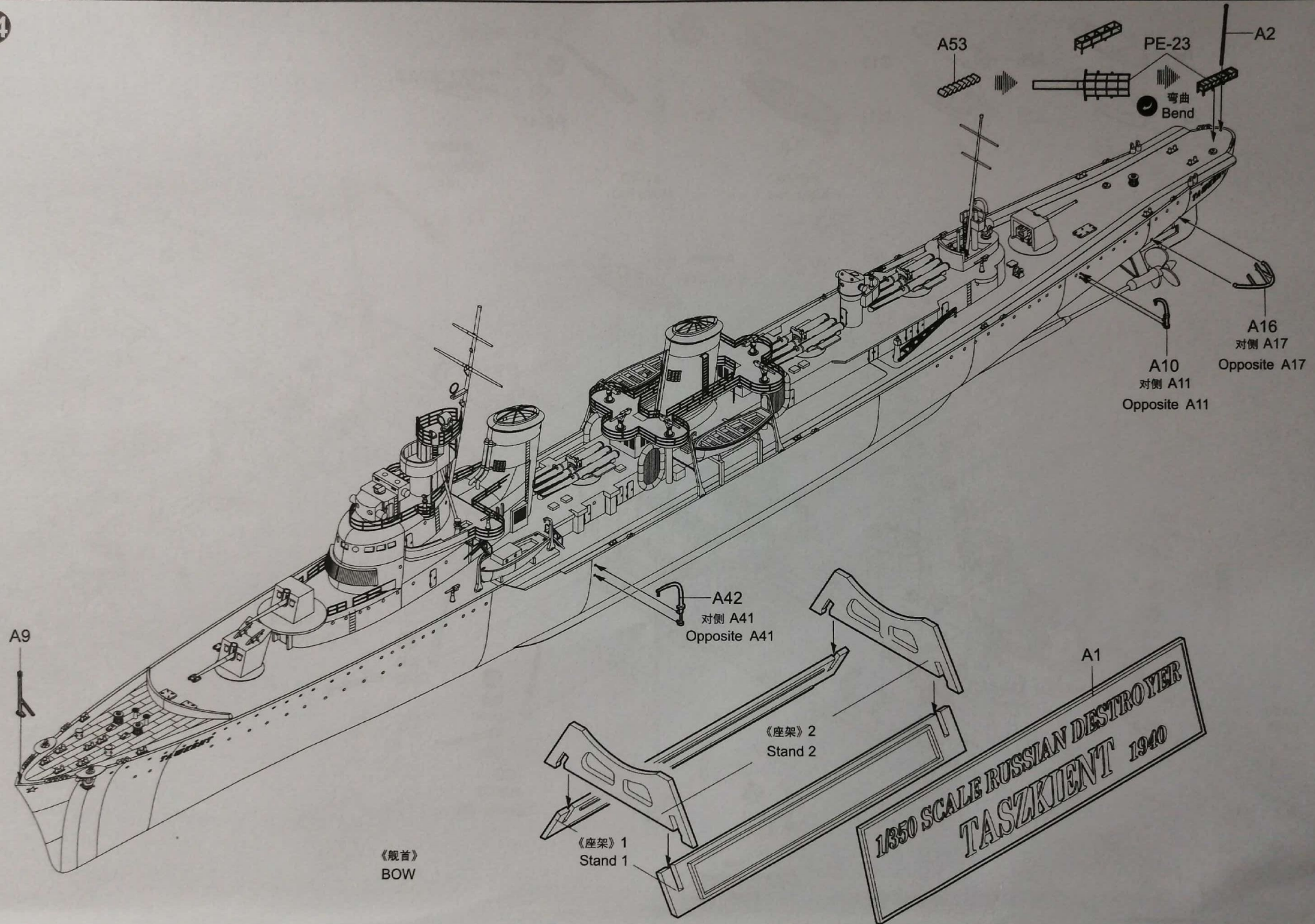



The kit consists of 106 parts on 10 sprue, 31 parts photo-etched and 3 tire.

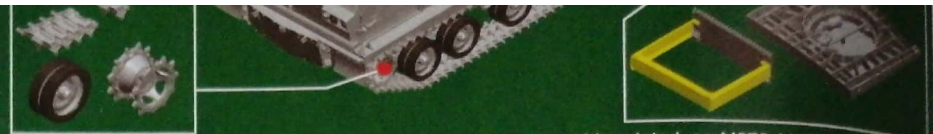

M270 MLRS (M270 Multiple Launch Rocket System, often abbreviated as M270 MLRS) is a feature armored self-propelled multiple rocket launcher weapon system. Since 1983, the U.S. military first used the M270 rocket launchers, NATO member states have begun to adopt a number of M270, and gradually become NATO standard weapons. After the United States and European countries produced a total of approximately 1,300 units of M270 and about 700,000 branch rocket. When in 2003, after delivery of the last batch of the Egyptian Army M270, M270 officially discontinued.

The kit consists of 806 parts on 30 sprue, 29 parts photo-etched and 2 copper tube.



Object 730 was a Soviet heavy tank of the Cold War, the final development of the KV and IS tank series. During development, it was called IS-8.

The kit consists of 535 parts on 23 sprue, 17 parts photo-etched and copper cable.

Soviet JS-5 Heavy Tank

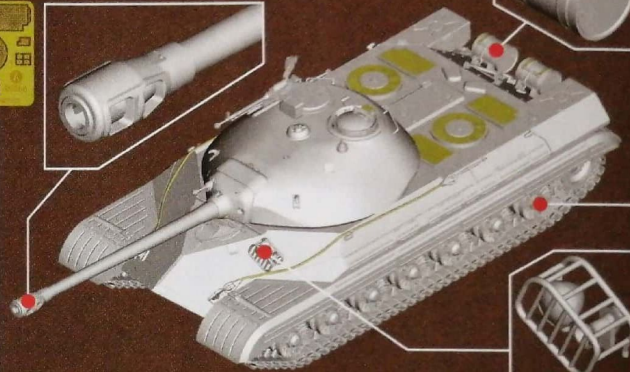
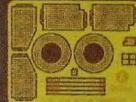

Tazskient lead destroyer on January 11, 1935 start of construction in Italy, November 28, 1937 launch, October 22, 1939 the Soviet Union to receive service. Tazskient design avant-garde at the time was an exception, it is one of the few speed can exceed 40 knots large ships during World War II, after the 1942 reform, even up to the light cruiser firepower level.

During World War II, as her main task is to transport people and goods to ship. In Sevastopol transport supplies to Soviet ships, the "Tazskient" was quite legendary, even the Germans know its name, it is surrounded by the Soviets before and after the delivery of supplies to dozens of times, during the German air force was air strikes more than 90 times, the Germans dropped bombs on it to a total of more than 400, a torpedo 10, but it only suffered a proximity bomb.

After the withdrawal of Tazskient Novorossiysk naval base, during an air raid on July 2 in the boat was completely destroyed in the stage, salvaged in 1944, because there was no repair value demolished in 1945.

The kit consists of 169 parts on 10 sprue, 50 parts photo-etched.

Russian Destroyer Tazskient 1940

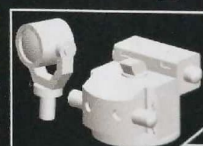
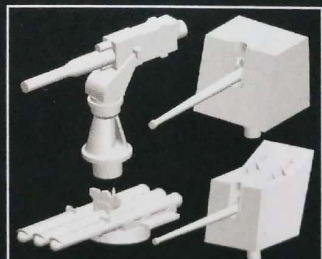

涂装同标贴指示
Painting & Marking guide

PAINT REFERENCE COLOR

Color	Mr.Hobby	Acrycion	Vallejo	Model Master	Tamiya	Humbrol	Color	Mr.Hobby	Acrycion	Vallejo	Model Master	Tamiya	Humbrol
Flat Black 消光黑	H 12 33	N 12	950	1749	XF1	33	Gold 金色	H 9 9	N 9	878	1744	X12	16
Rim78 Light Blue 浅兰色	H 118 118	N 118	--	--	--	175	Field Green 原野绿	H 340 340	N 340	--	1712	XF26	105
Hull Red 舰底红	H 17 29	N 17	985	--	XF9	177	Neutral Gray 灰色	H 53 13	N 53	992	--	--	5
Tan 黄褐色	H 27 44	N 27	981	--	--	9	Flat White 消光白	H 11 62	N 11	951	1768	XF2	34
Silver 银色	H 8 8	N 8	997	1546	X11	11							

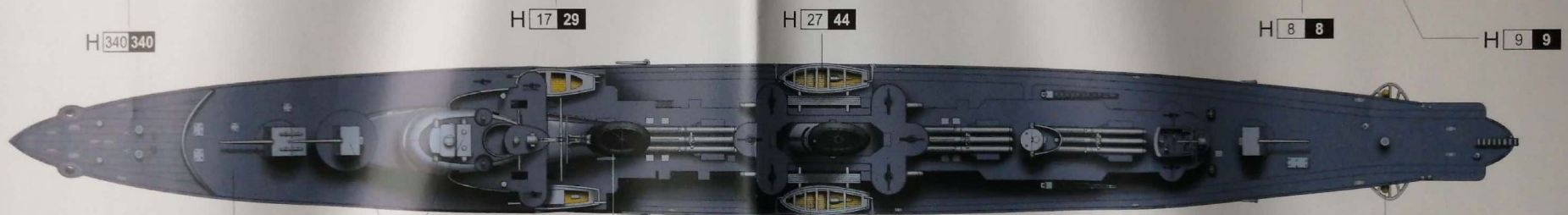
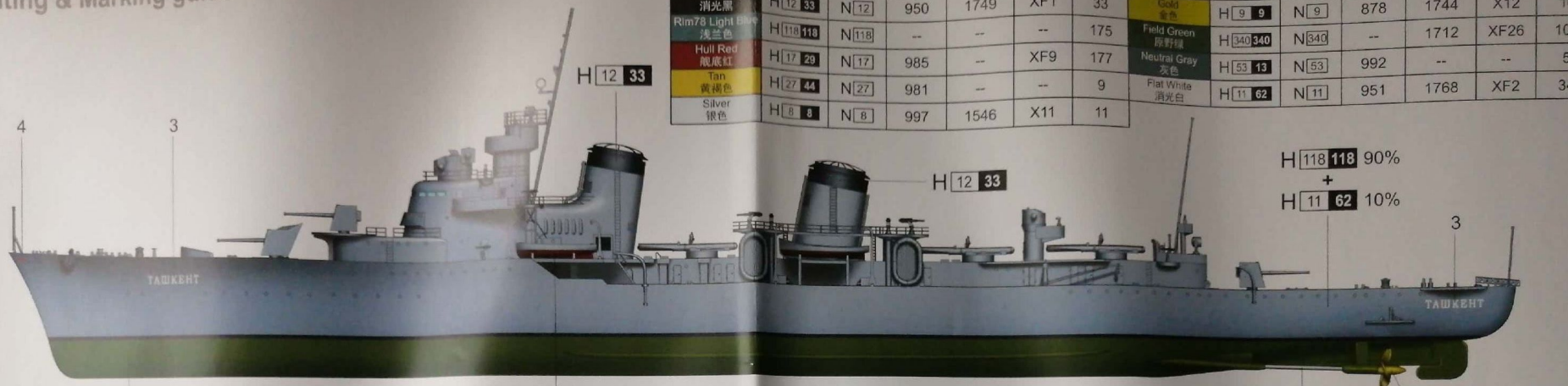

H AQUEOUS HOBBY COLOR Mr. COLOR N ACRYSION COLOR

05356 1/350 Russian Destroyer Tazskient 1940