

1:72 SCALE

ITEM NO.:01621

CH-47A Chinook CH-47A “支努干”



READ BEFORE ASSEMBLY:

- This kit is not recommended for inexperienced modelers or for children under 14 years of age
- Study and understand these instructions thoroughly before beginning assembly
- When needed, remove photo-etch parts carefully using a modeling knife or photo etch sprue cutter, being careful not to damage or lose small parts.
- Take extra care in handling photo etch parts in order to avoid injury
- Apply instant cement sparingly to photo etch parts where instructed
- Tools recommended(not included in kit):Plastic and instant cements, sprue cutters,long nose pliers,,modeling knife, small files, tweezers, pin vise & scissors. Soft cloth and sandpaper will also assist in construction
- Glue and paint are not included in the kit. Use plastic cement and hobby paints only. Color guide for purchasing paint is included in the kit.
- Keep out of reach of children. They must not be allowed to ingest small parts or handle plastic bags in any way.

装配之前仔细阅读

- 小心用模型锉刀锉平所有零件表面的注射浇口。
- 小心用刀片切下蚀刻片零件，不要遗失小零件。
- 用强力快干胶水粘合蚀刻片零件和金属轴。过量快干胶水使用可能导致可动零件会粘住，小心涂胶。
- 取蚀刻片时应特别注意安全，防止利边划伤手指。
- 某些零件表面需贴水上贴纸，请选择在装配的同时进行。
- 推荐模型工具(自备)：胶水，水口剪刀，长咀钳，刀片，锉刀，镊子，钳，钻，剪刀，瞬间快干胶。
- 软布同砂纸同时也应该是必备工具。
- 请使用塑料胶水和油漆，模型内不含。
- 谨防小孩吸吮塑料零件，或者将塑料袋套在头上，制作时应将套材远离小孩接触。
- 本产品不适合14岁以下没有经验的模型爱好者。



Cyanoacrylate glue
使用强力胶



Weight
配重



Make hole
钻孔



Cut /Remove
切除



Bend
弯曲



File / Sand
锉平



Option
选择



No cement
不涂胶水



Decal
贴纸

水贴纸的使用:

1. 从水贴纸上剪下印花;
2. 将印花放入温水中浸10秒, 然后放在干净布上。
3. 拿着印花纸板将印花移到模型上;
4. 手指蘸水将印花移到适当的位置;
5. 用软布轻压印花直至水干, 汽泡消失。

DECAL APPLICATION

1. Cut off decal from sheet.
2. Dip the decal in tepid water 40°C for about 10 sec. and place on a clean cloth.
3. Hold the backing sheet edge and slide decal onto the model.
4. Move decal into position by wetting decal with finger.
5. Press decal gently down with a soft cloth until excess water and air bubbles are gone.

部品图
PART

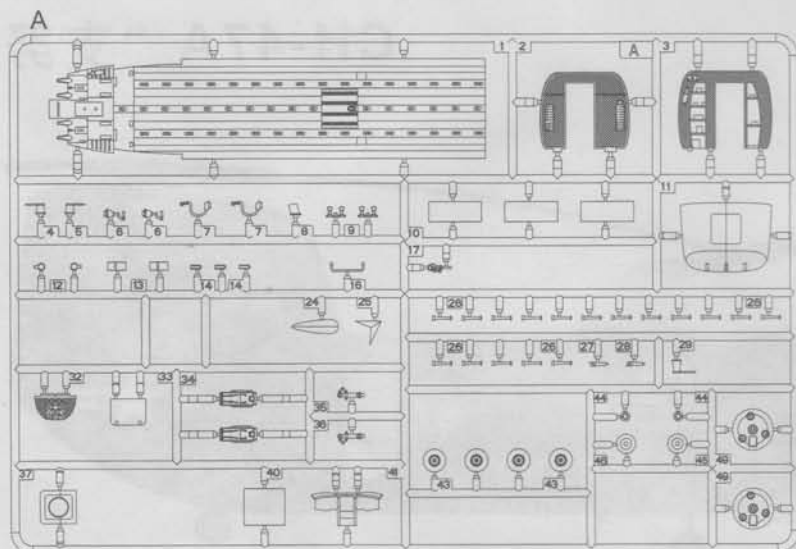

《左机身》
Left fuselage

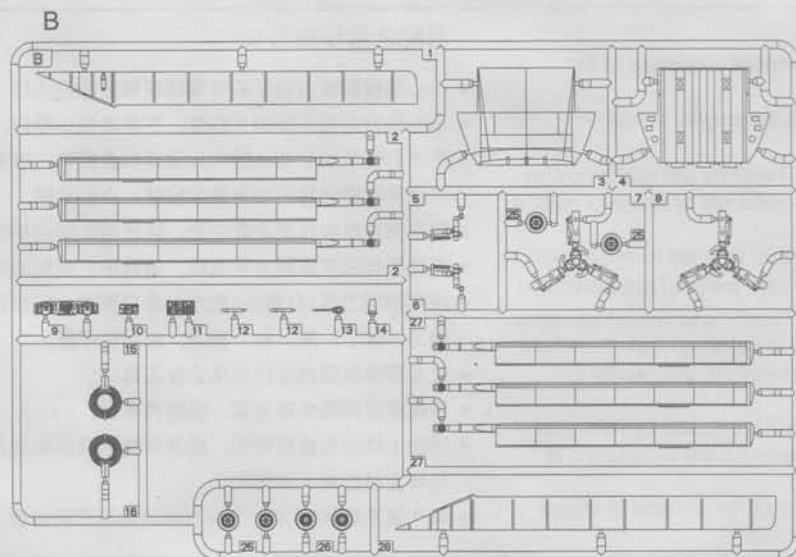

《右机身》
Right fuselage

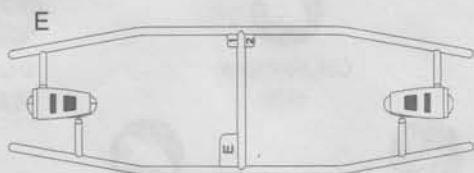

轴: $\varnothing 1.5 \times 9.5\text{mm}$
Shaft  $\times 2$

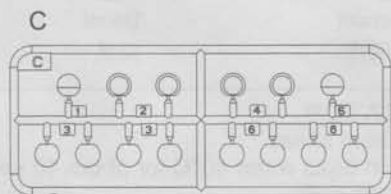

《座舱罩》
Canopy

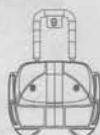

《水贴》
Decal

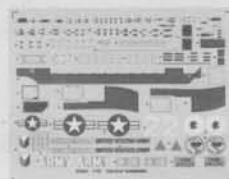

1

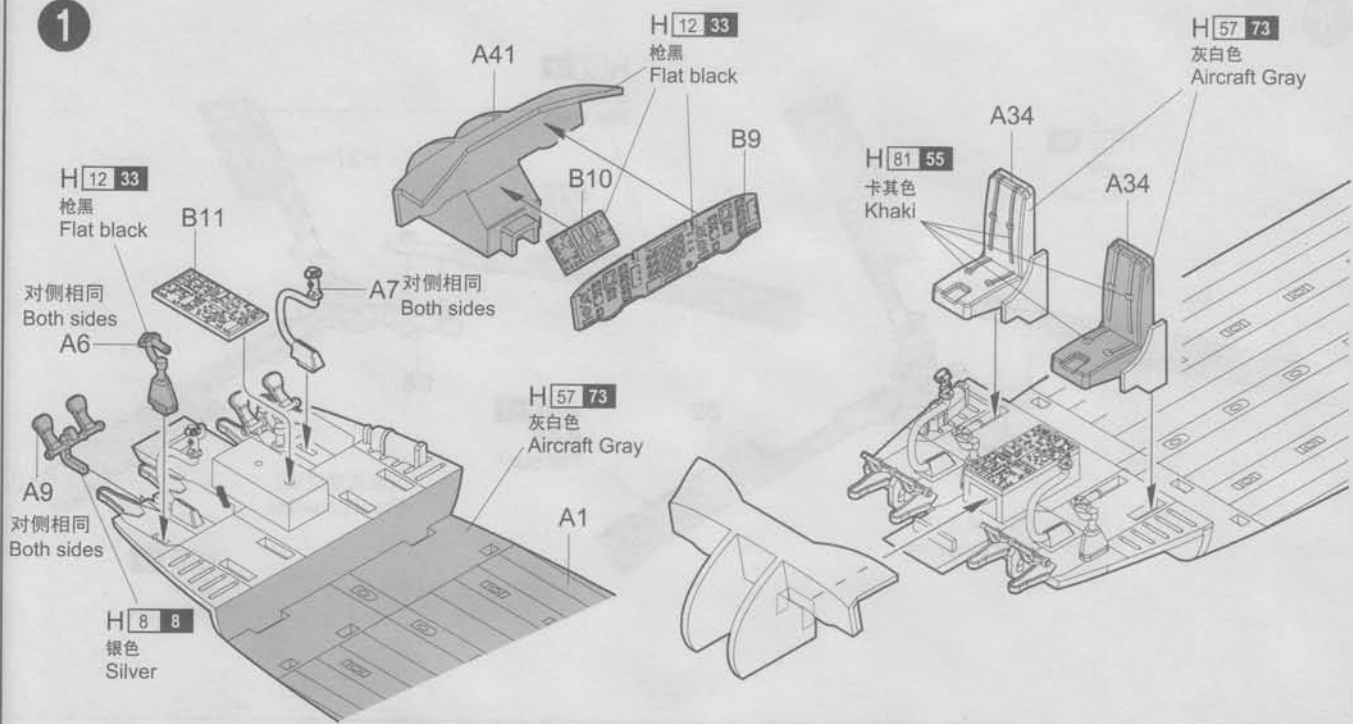

2

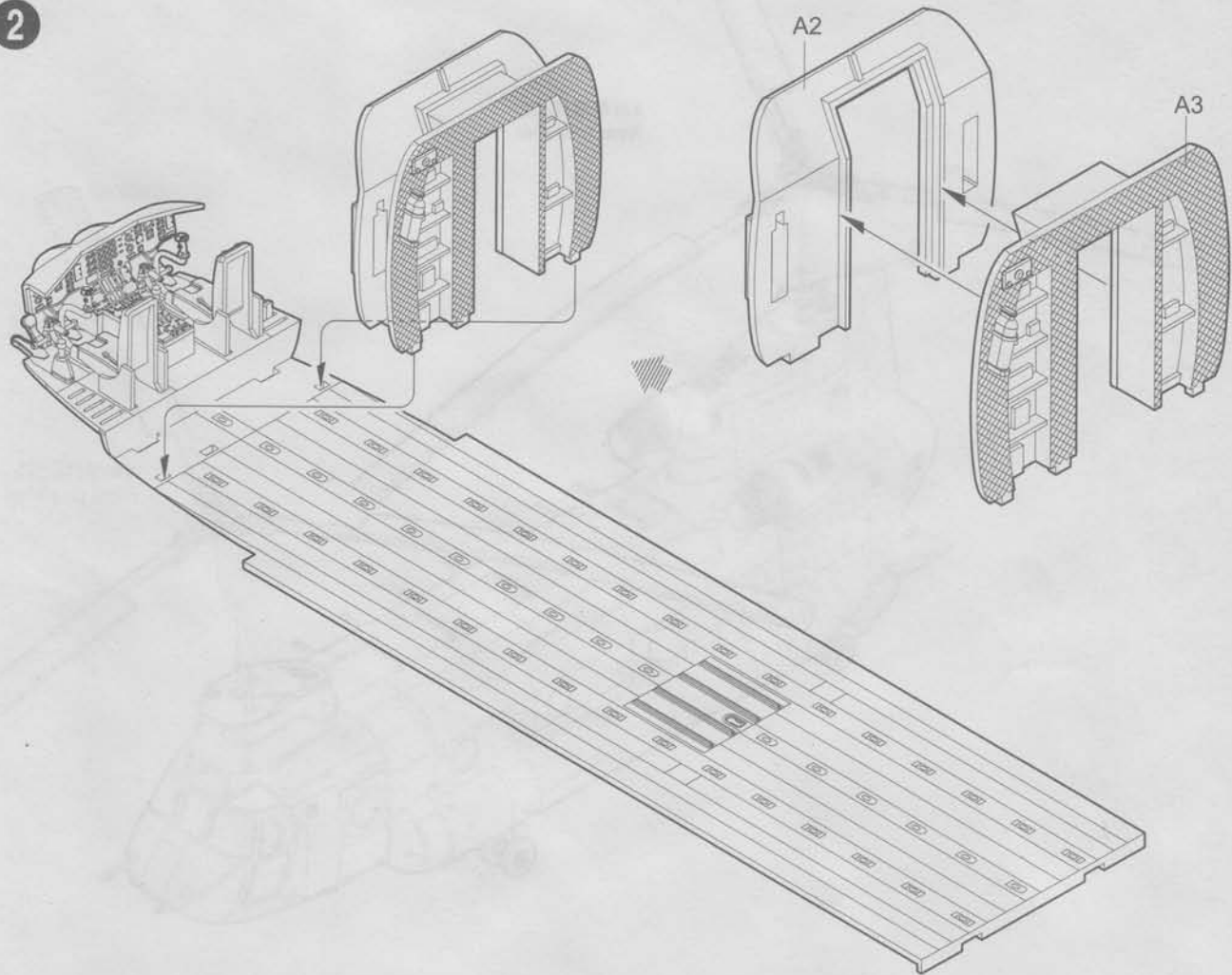

3

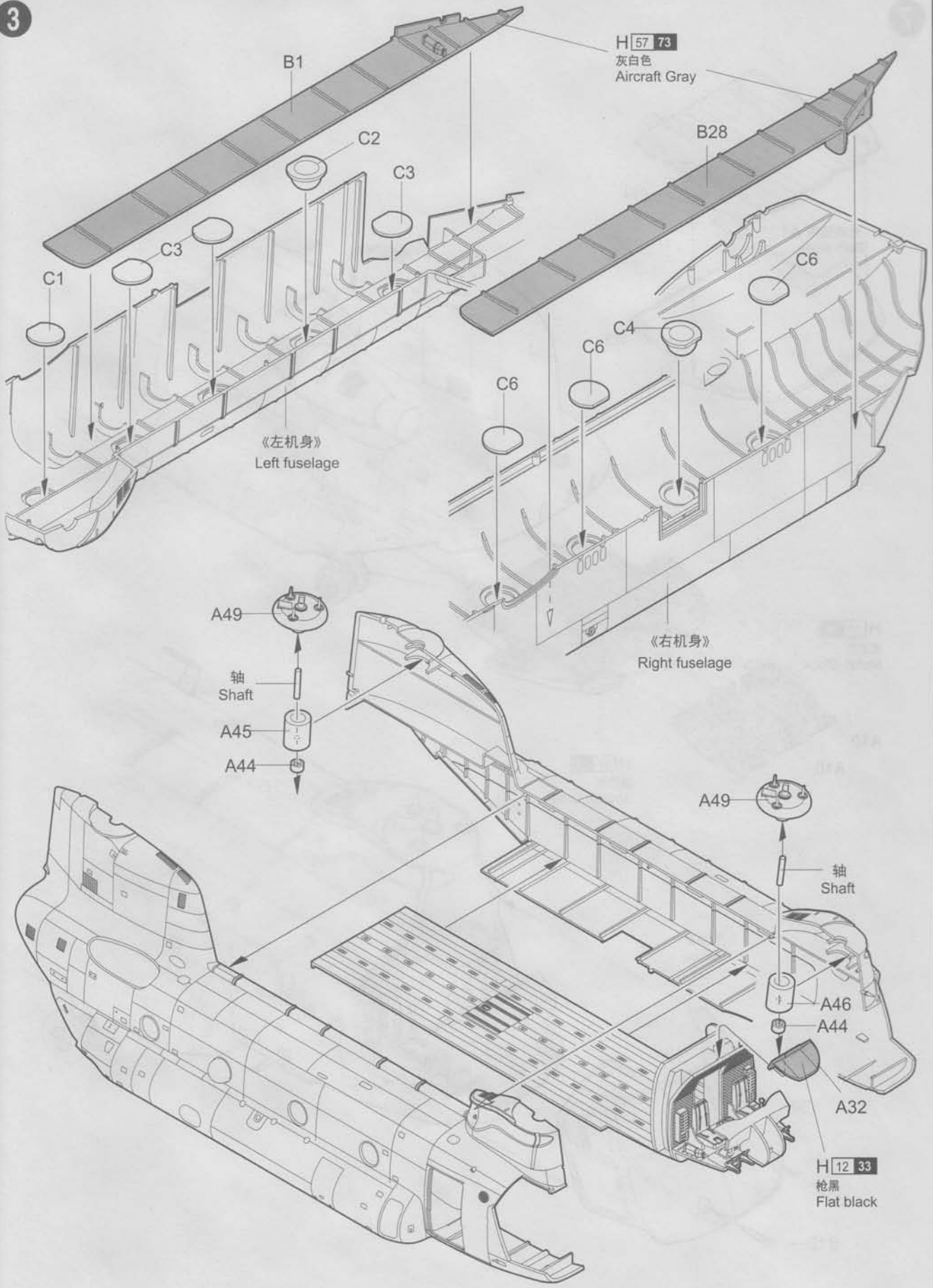

H 57 73
灰白色
Aircraft Gray

B1

B28

C2

C3

C6

C1

C3

C4

C6

C6

《左机身》
Left fuselage

《右机身》
Right fuselage

A49

轴
Shaft

A45

A44

A49

轴
Shaft

A46
A44

A32

H 12 33
枪黑
Flat black

4

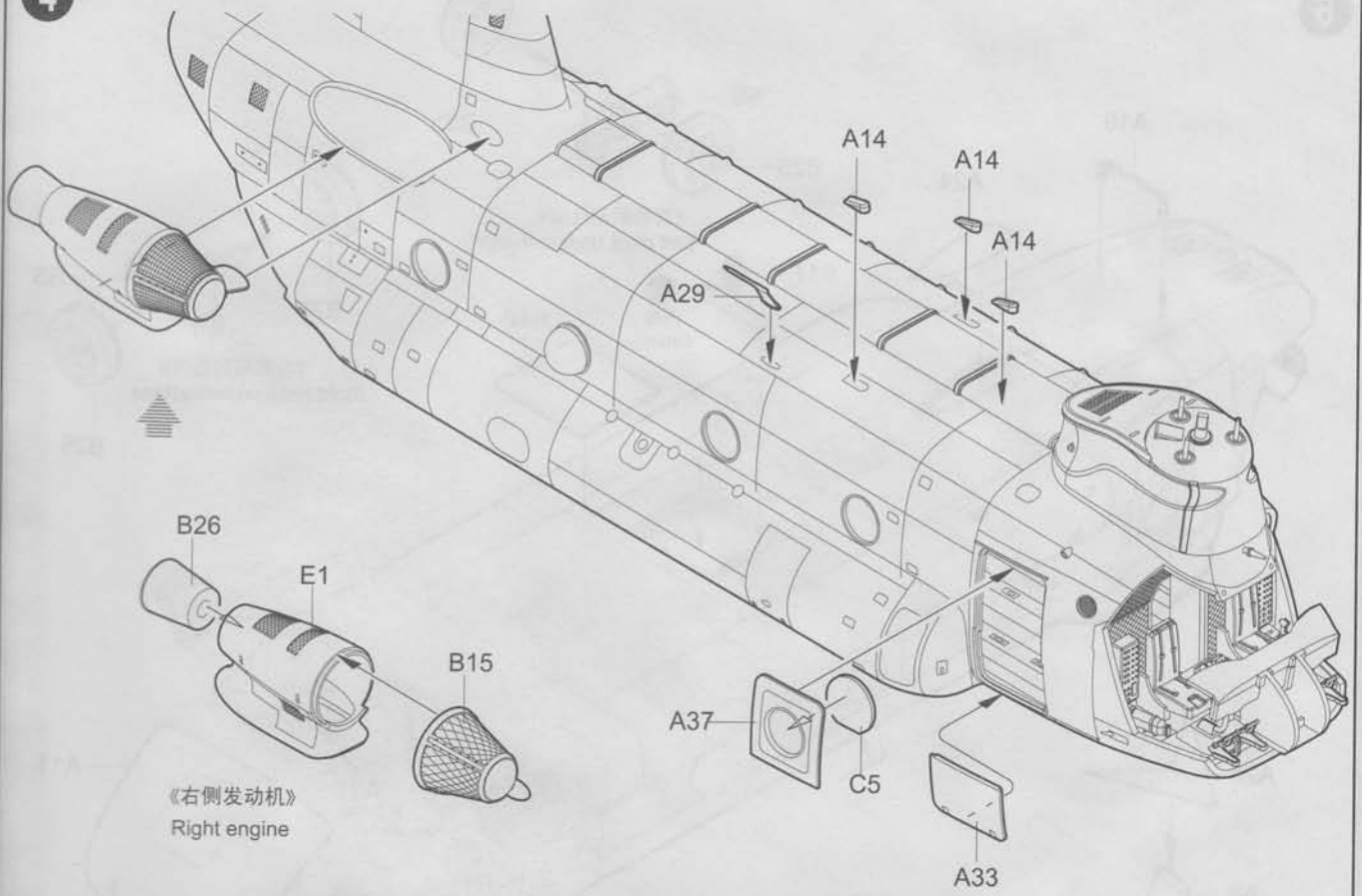

5

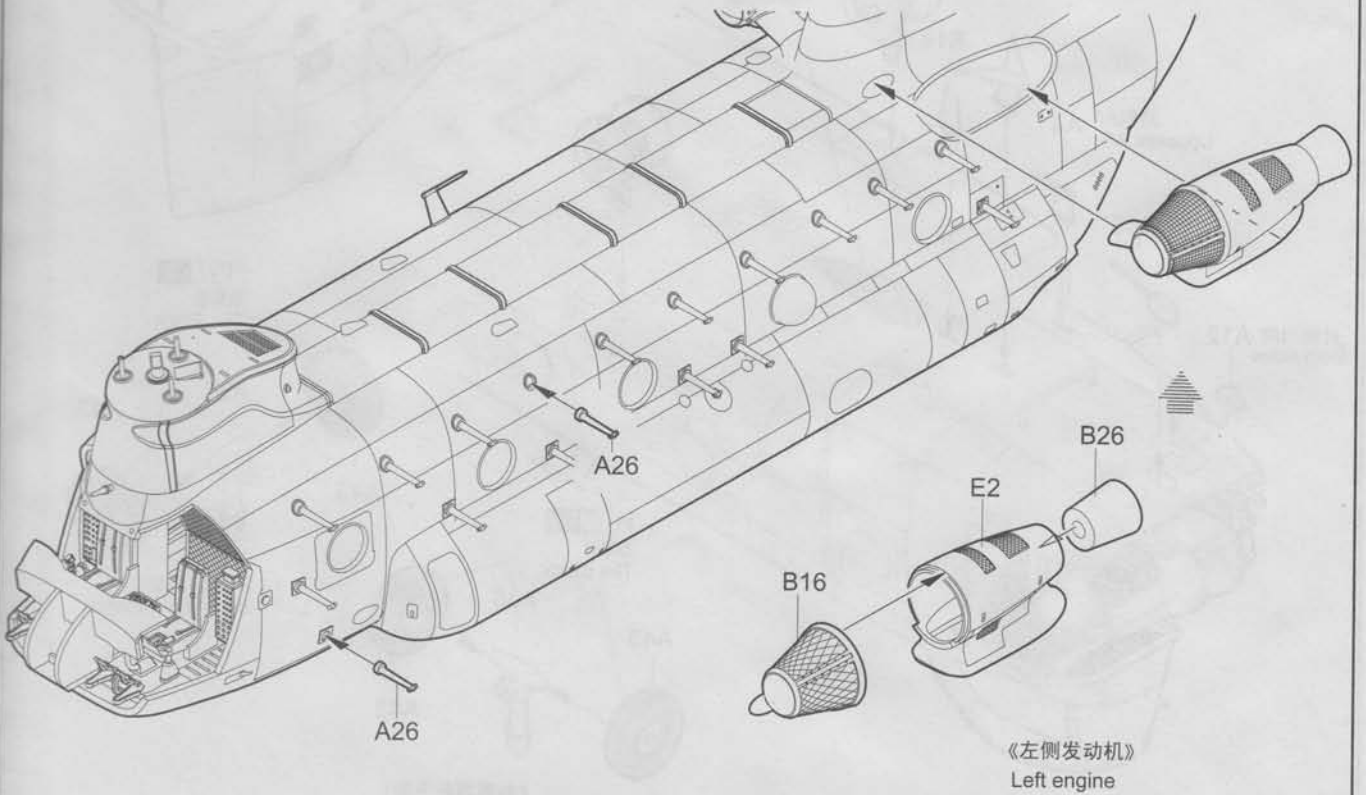

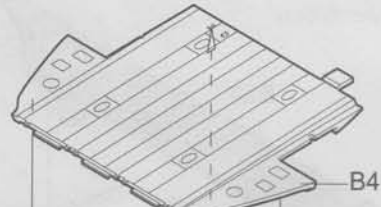

B4

对侧相同 A13
Both sides

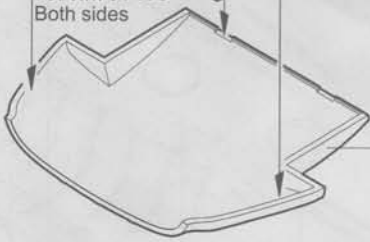

B3

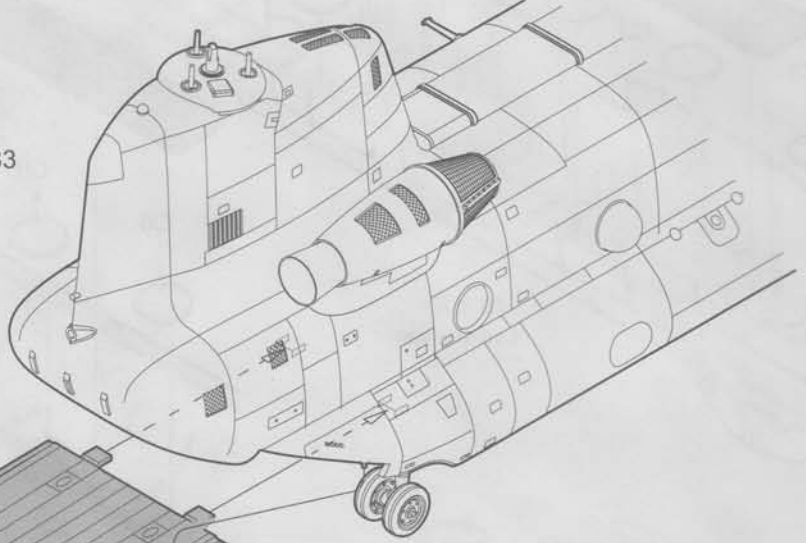

H 18 28

黑铁色
Metal Black

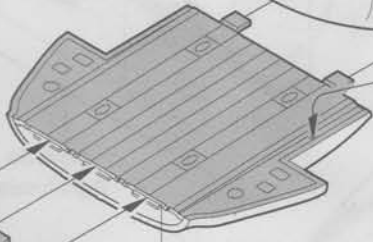

A10

A10

A10

H 57 73

灰白色
Aircraft Gray

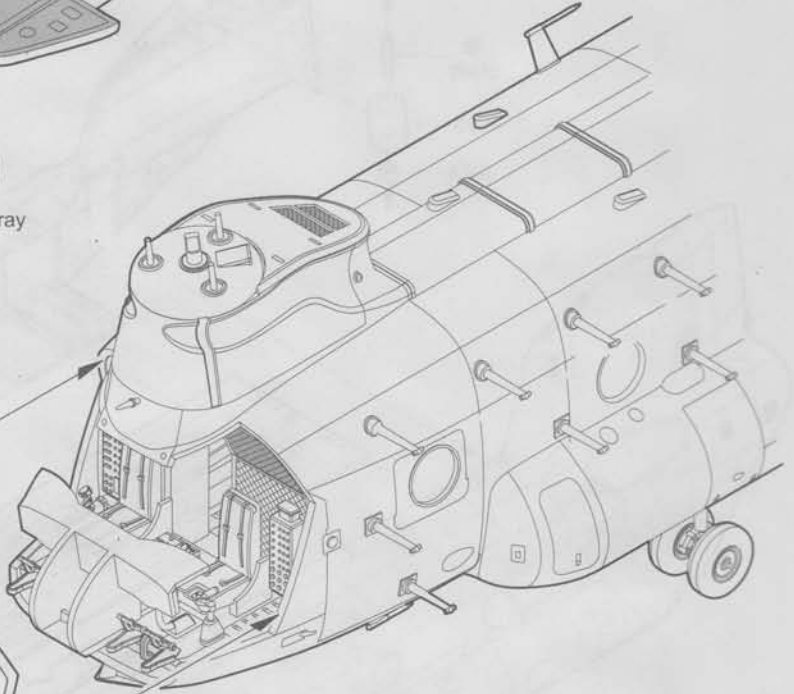

《座舱罩》
Canopy

C9

B12

B12

8

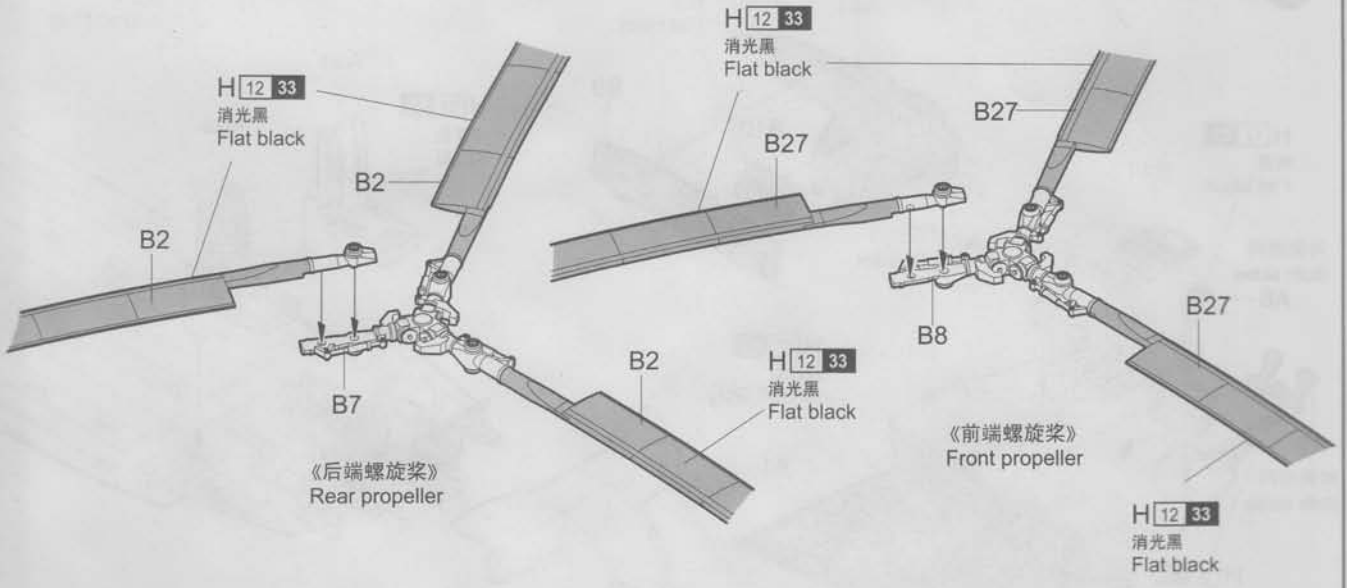

9

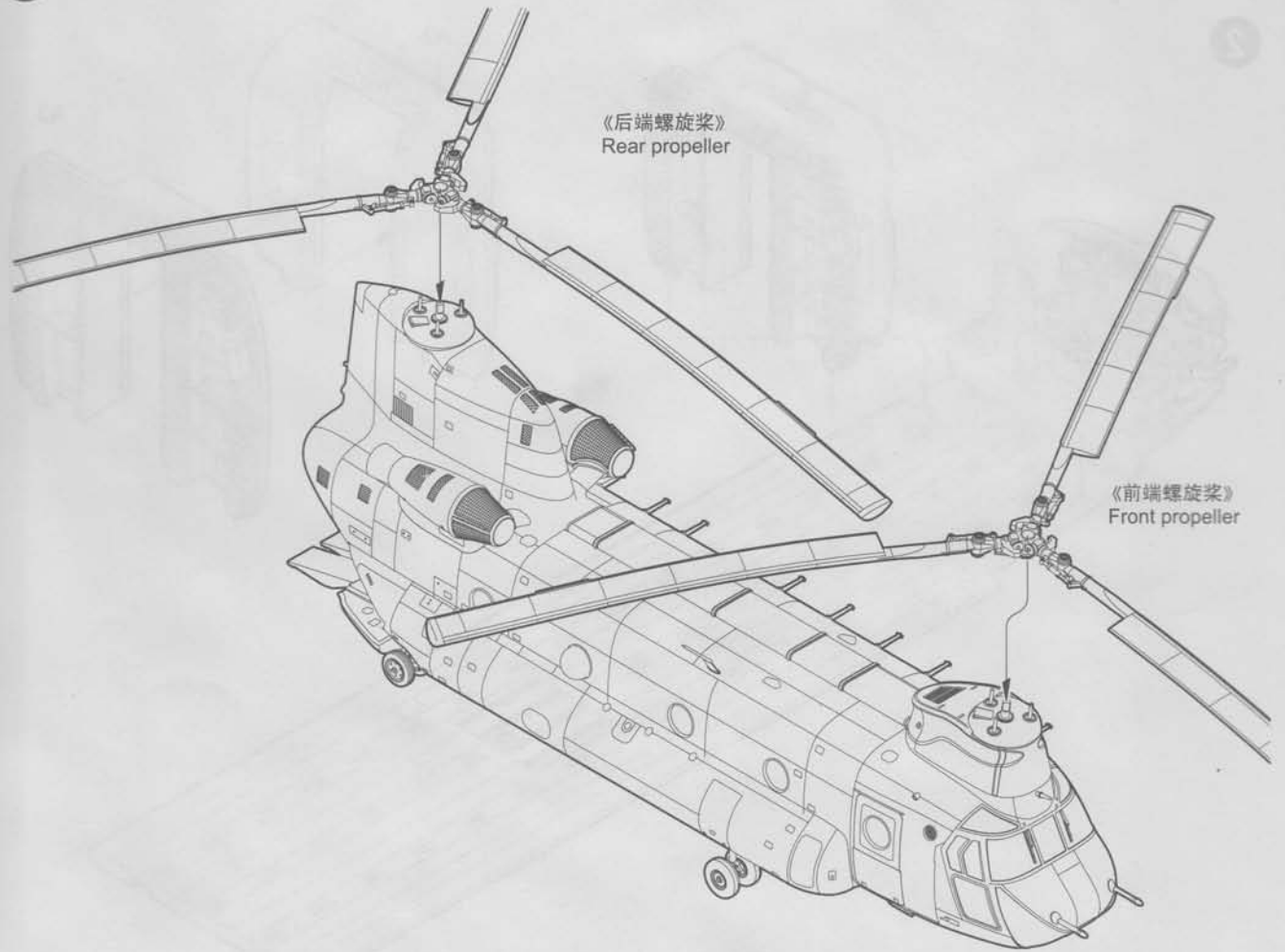

涂装同标贴指示
Painting & Marking guide

63 61

使用MR.HOBBY涂料
Mr. color used

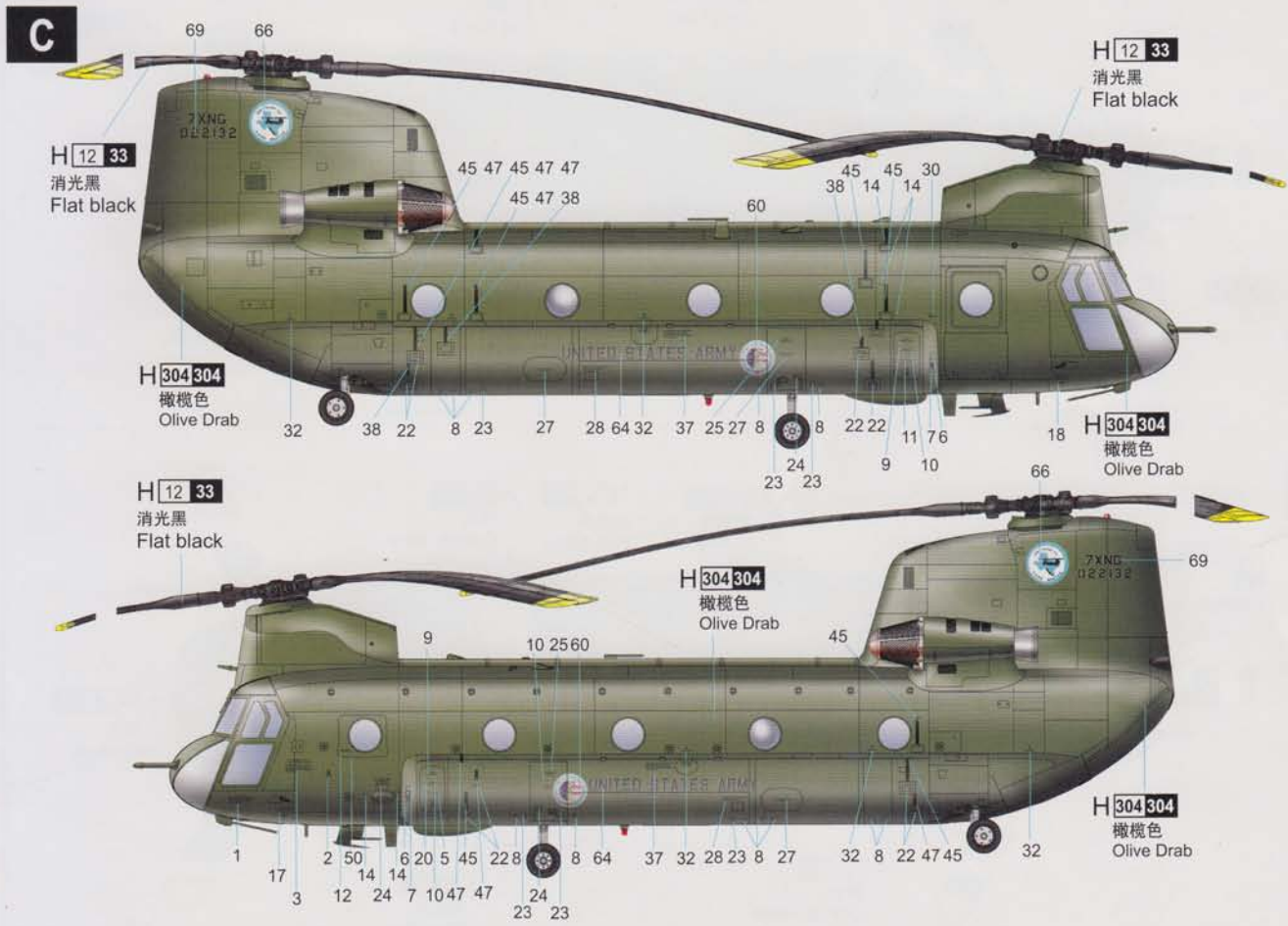
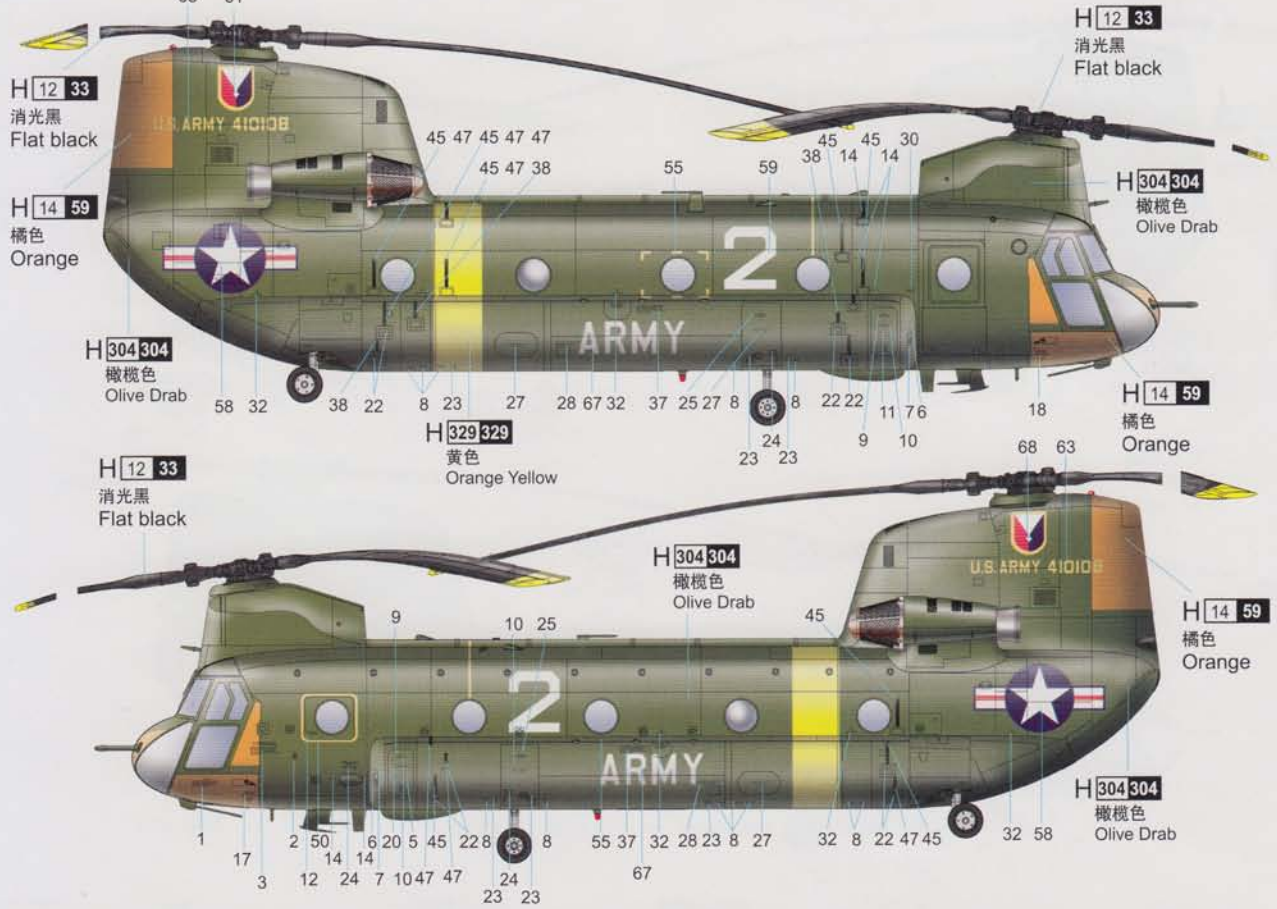

H □ AQUEOUS HOBBYCOLOR

■ Mr. COLOR