

1:700 SCALE **USSR AIRCRAFT CARRIER**

前苏联明斯克号航空母舰

颜色指示
COLOR

白色	White	金色	Gold
黑色	Black	浅灰色	Light gray
蓝色	Blue	明灰白	ljn gray
绿色	Green	橙色	Orange

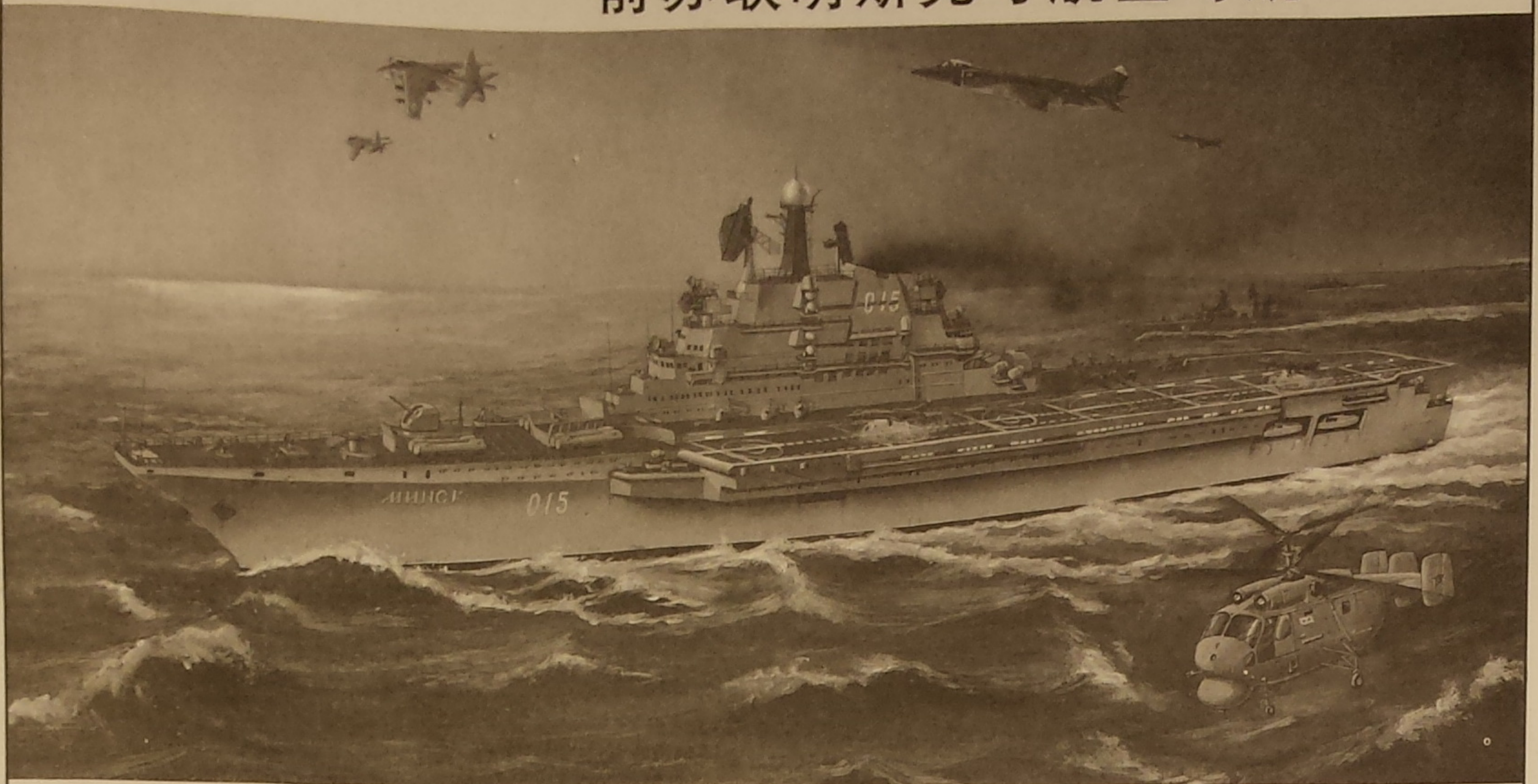
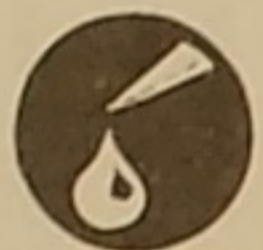

cyanoacrylate glue
使用强力胶

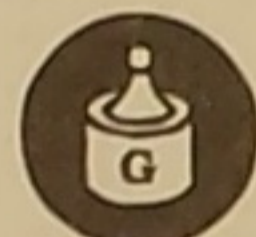

weight
配重

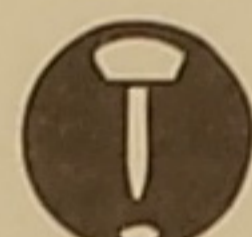

make hole
钻孔

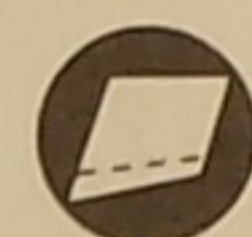

cut / remove
切除



bend
弯曲



file / sand
锉平

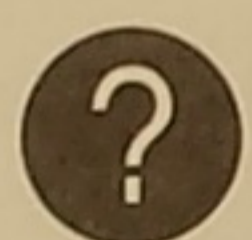

option
选择



no cement
不涂胶水

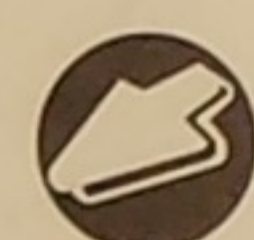

decal
贴纸

水贴纸的使用:

1. 从水贴上剪下印花;
2. 将印花放入温水中浸10秒, 然后放在干净布上。
3. 拿着印花纸板将印花移到模型上;
4. 手指蘸水将印花移到适当的位置;
5. 用软布轻压印花直至水干, 气泡消失。

DECAL APPLICATION

1. Cut off decal from sheet.
2. Dip the decal in tepid water 40°C for about 10 sec. and place on a clean cloth.
3. Hold the backing sheet edge and slide decal onto the model.
4. Move decal into position by wetting decal with finger.
5. Press decal gently down with a soft cloth until excess water and air bubbles are gone.

部品图
Parts

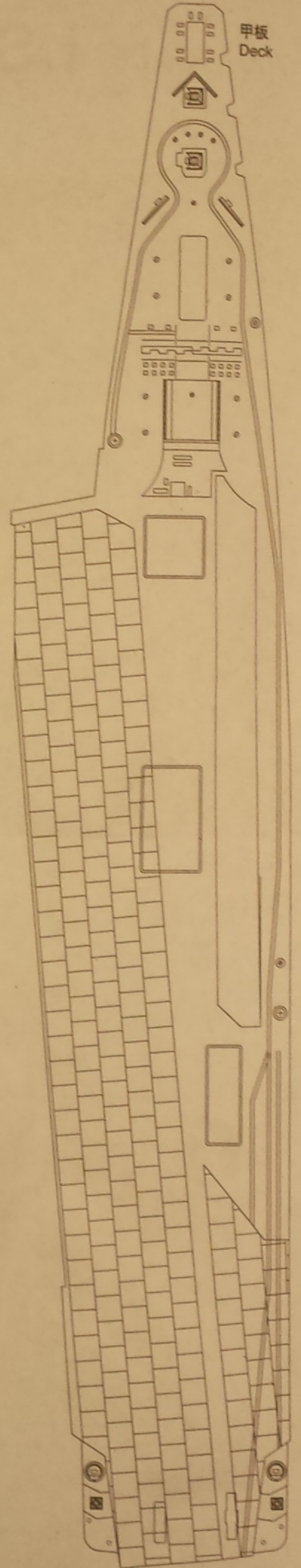
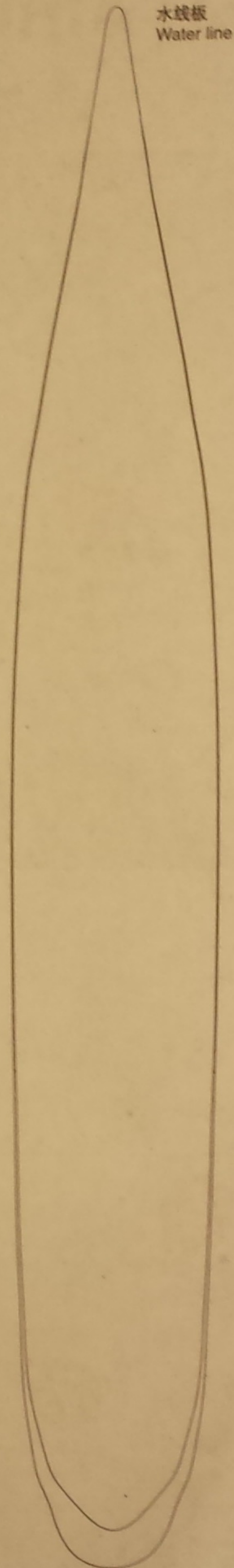
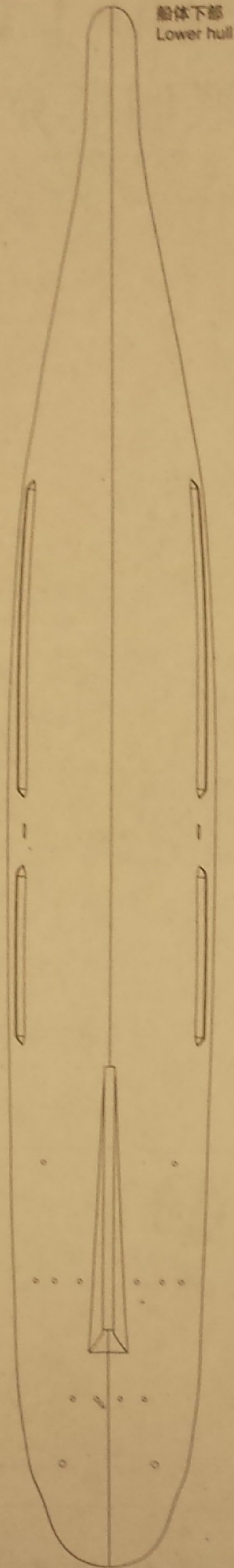
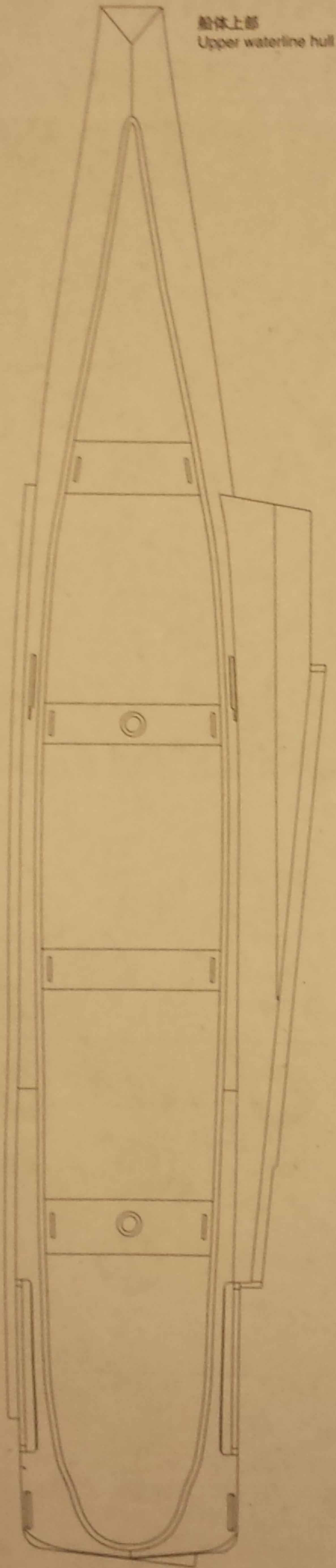

舰桥
Bridge

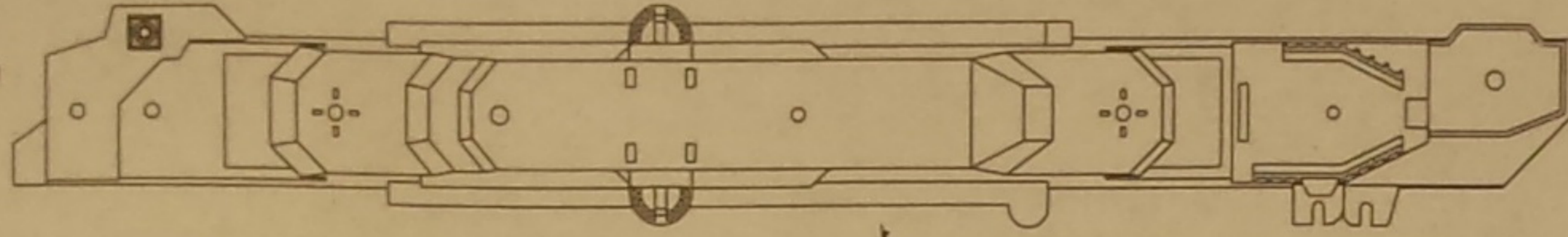

部品A
Parts A

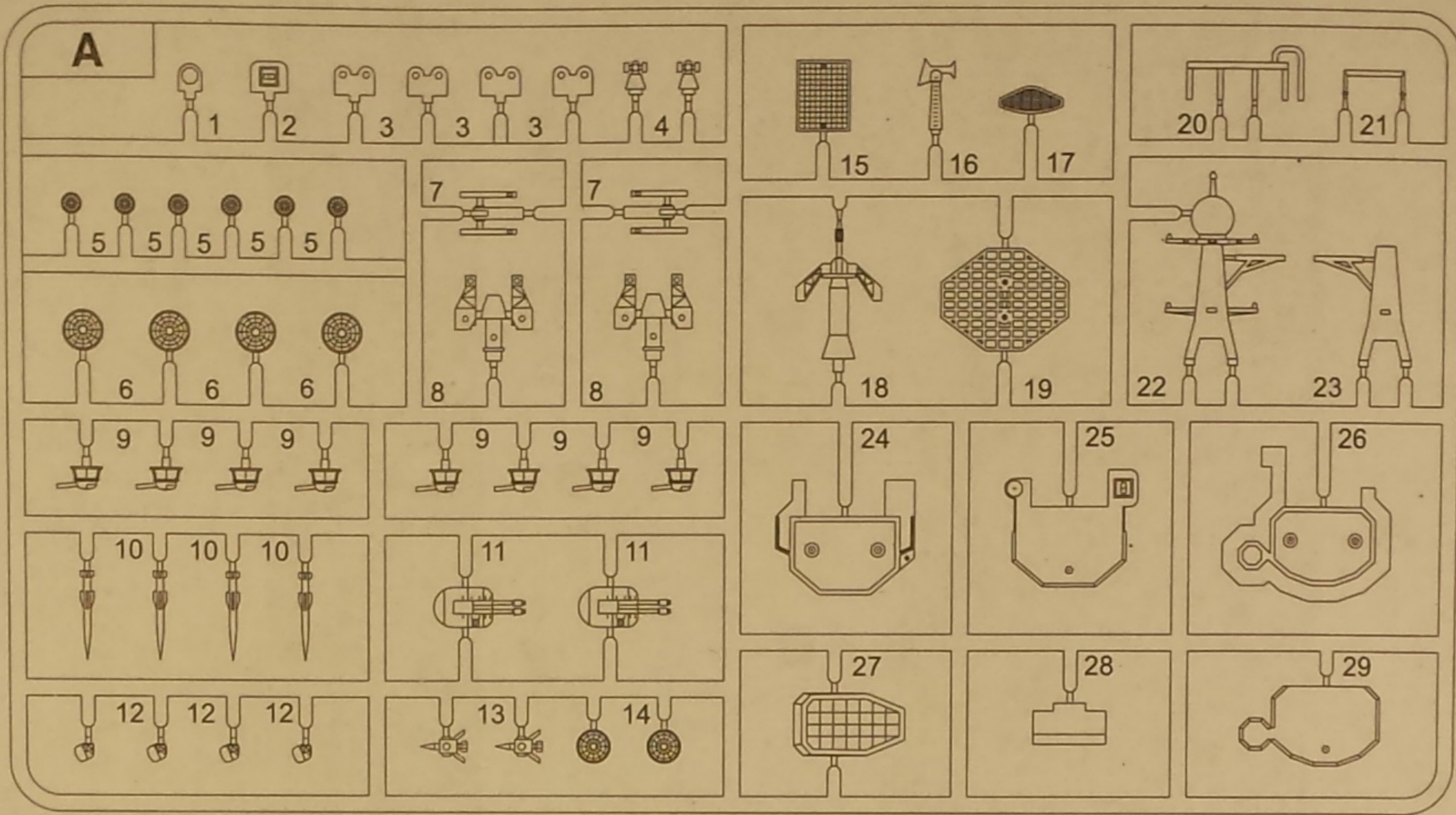

部品B
Parts B

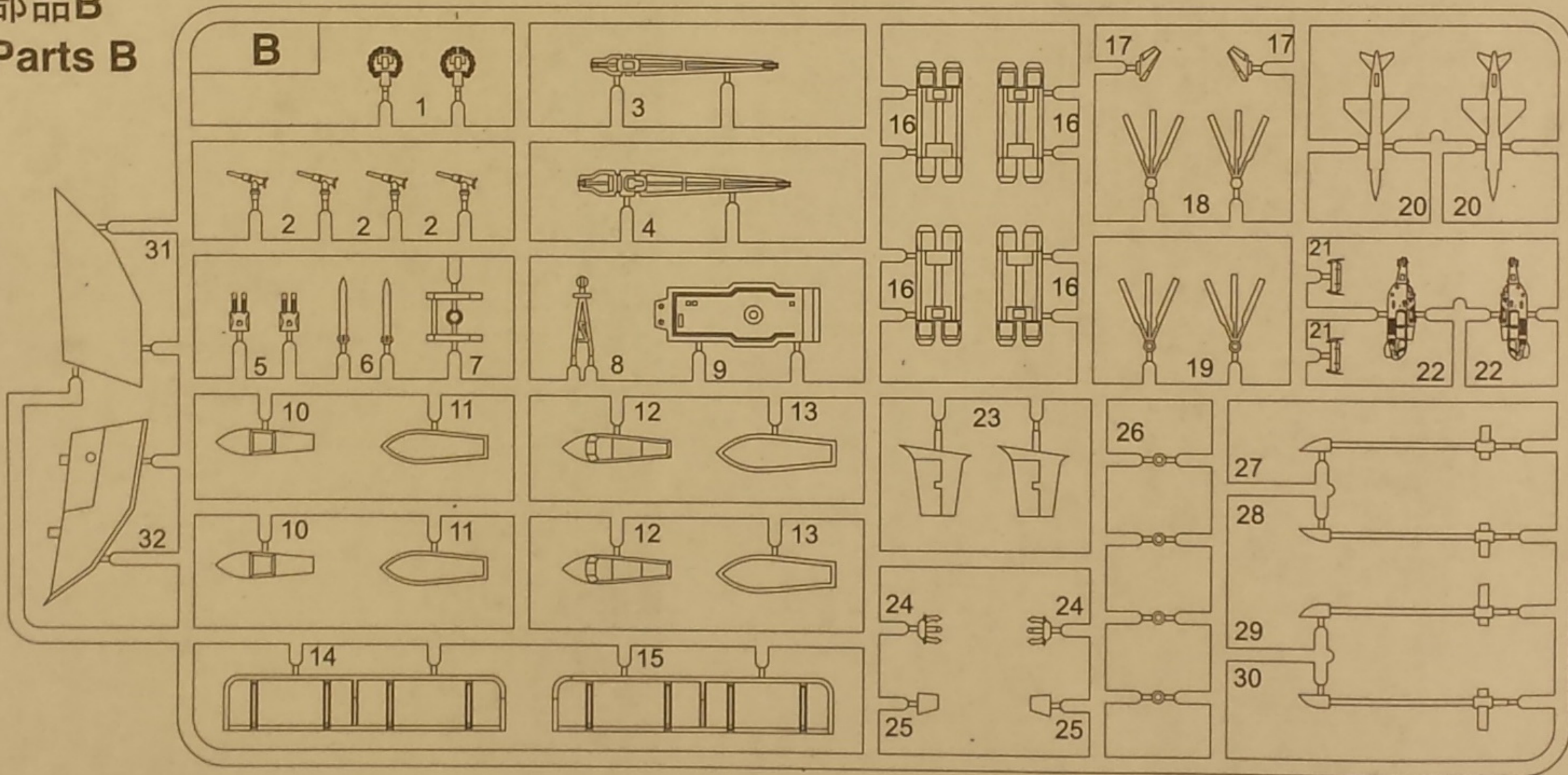

F 座架
Stand

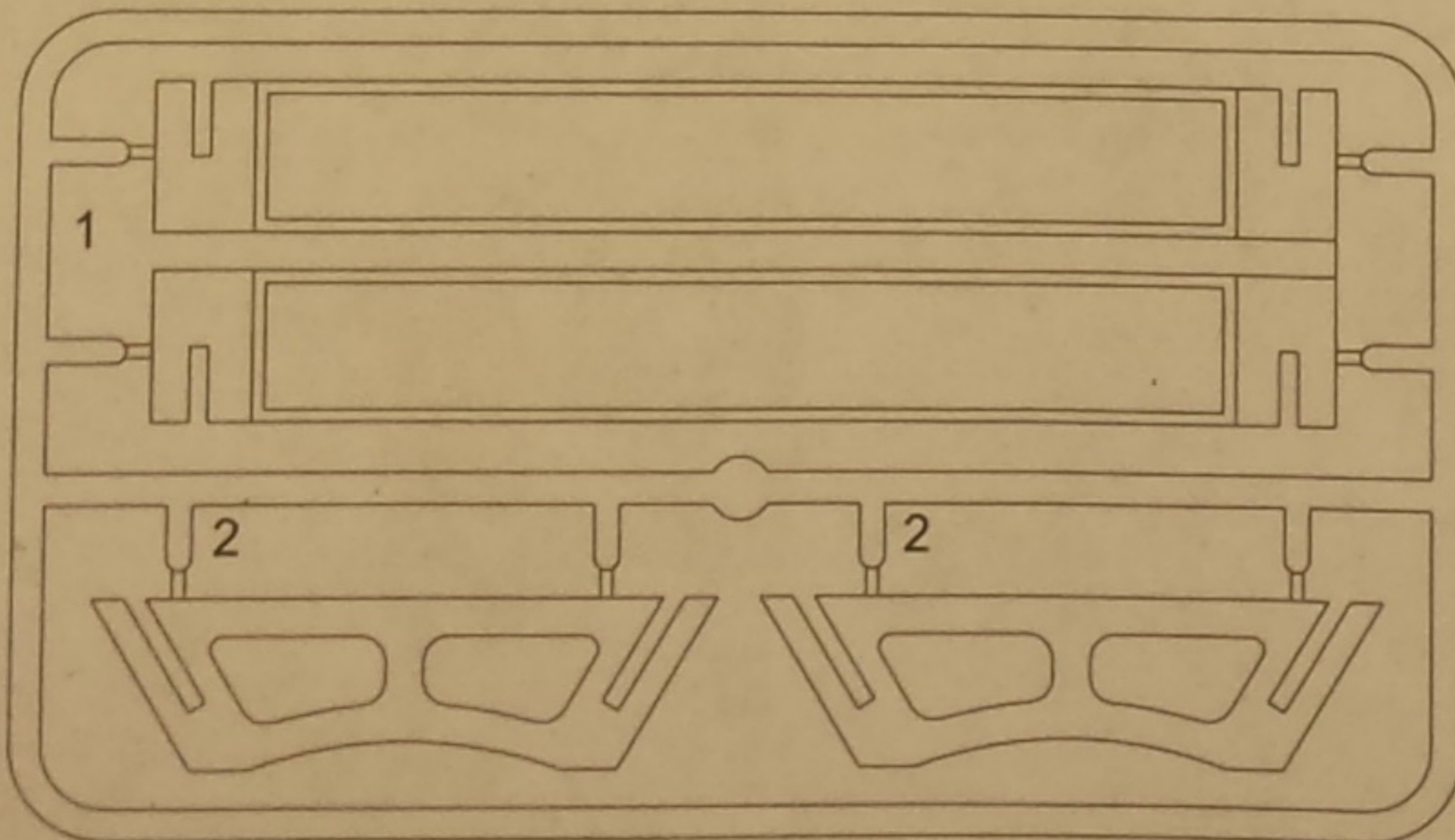

Brass propellers

Left × 2 Right × 2



1

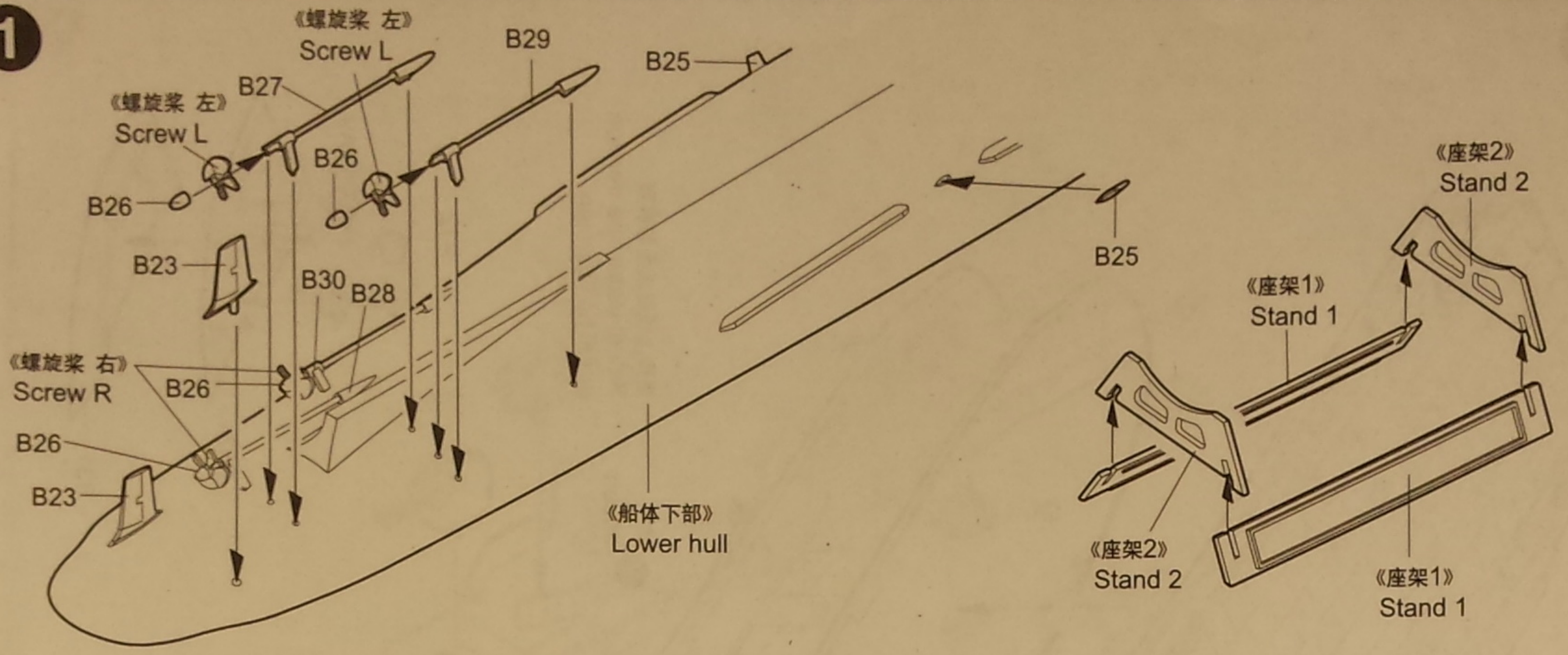

2

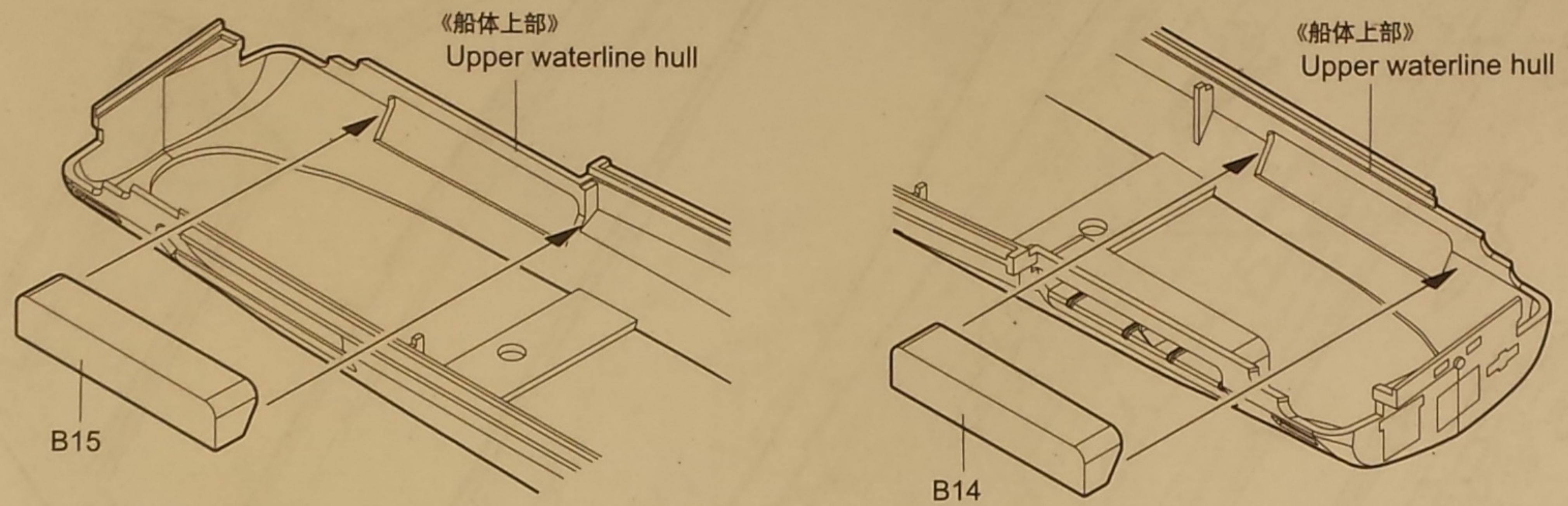

3

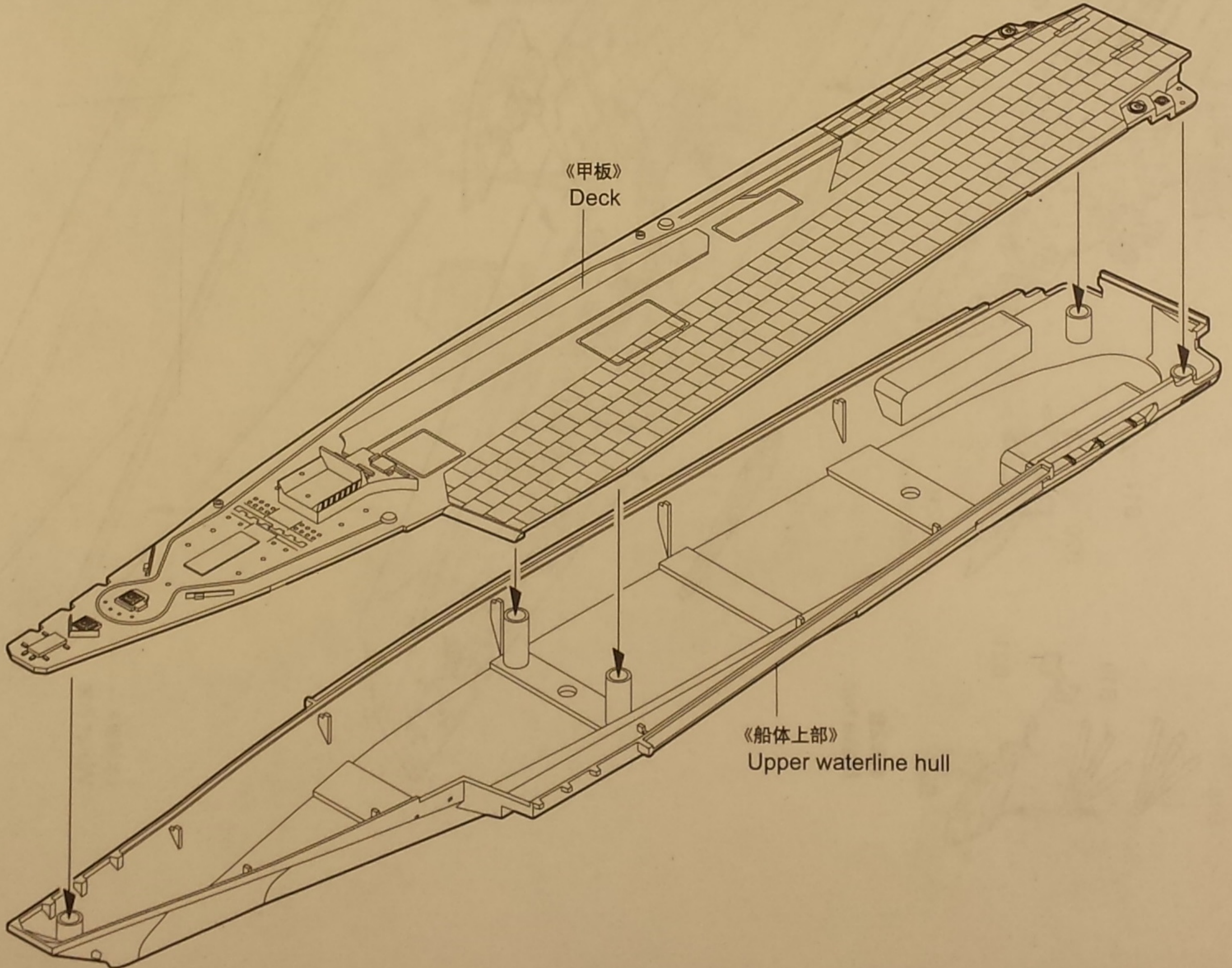

4

《救生艇 A》
Life boat A

《救生艇 B》
Life boat B

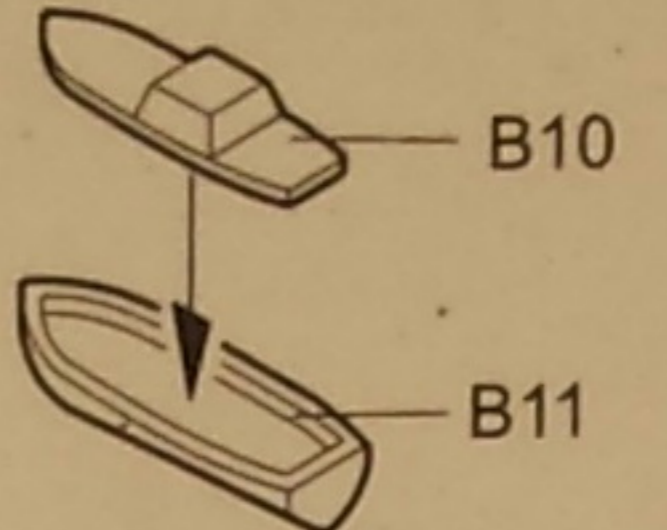
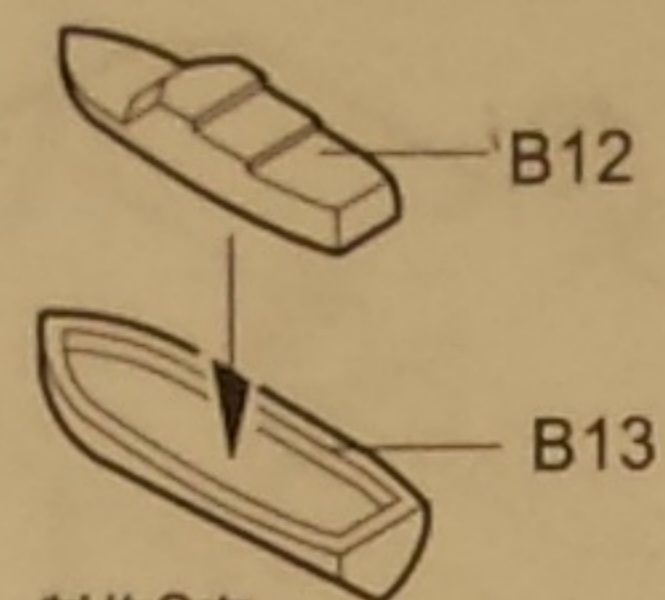

制作2套
Make two

制作2套
Make two

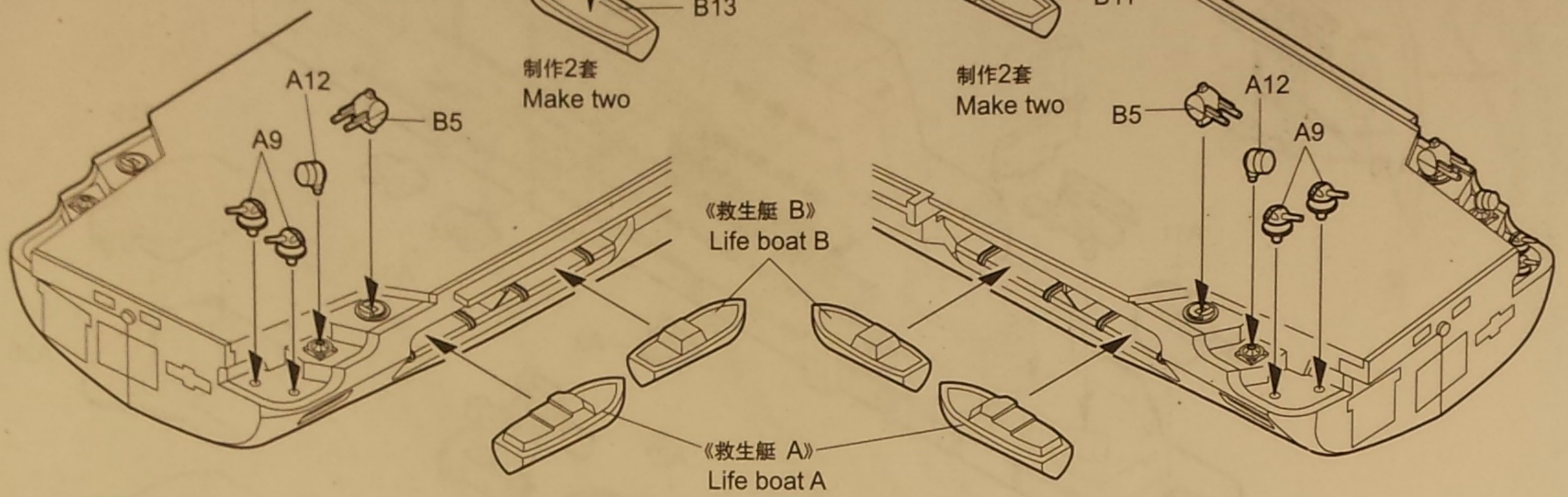

5

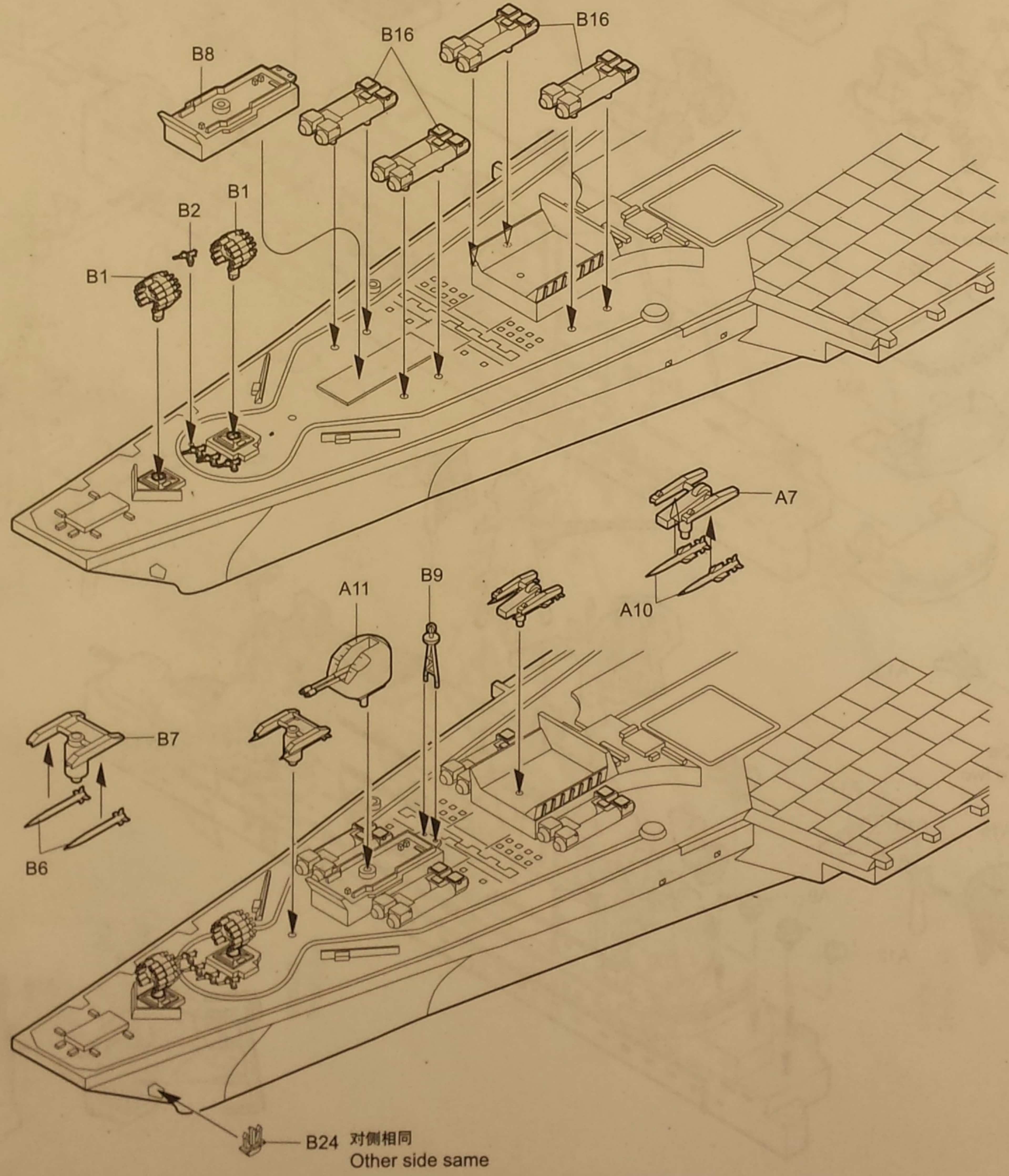

《舰桥》
Bridge

