



USS Gerald R. Ford CVN-78

美国海军“福特”号航空母舰

READ BEFORE ASSEMBLY:

- This kit is not recommended for inexperienced modelers or for children under 14 years of age
 - Study and understand these instructions thoroughly before beginning assembly
 - When needed, remove photo-etch parts carefully using a modeling knife or photo etch sprue cutter, being careful not to damage or lose small parts.
 - Take extra care in handling photo etch parts in order to avoid injury
 - Apply instant cement sparingly to photo etch parts where instructed
 - Tools recommended(not included in kit):Plastic and instant cements,sprue cutters,long nose pliers,modeling knife, small files, tweezers, pin vise & scissors. Soft cloth and sandpaper will also assist in construction
 - Glue and paint are not included in the kit. Use plastic cement and hobby paints only. Color guide for purchasing paint is included in the kit.
 - Keep out of reach of children. They must not be allowed to ingest small parts or handle plastic bags in any way.
- * 说明书中含有重要信息，应保留。 Please Keep instruction since it contains important information.

装配之前仔细阅读

- 小心用模型锉刀锉平所有零件表面的注射浇口。
- 小心用刀片切下蚀刻片零件，不要遗失小零件。
- 用强力快干胶水粘合蚀刻片零件和金属轴。过量的快干胶水使用可能导致可动零件会粘住，小心涂胶。
- 取蚀刻片时应特别注意安全，防止利边划伤手指。
- 某些零件表面需贴水上贴纸，请选择在装配的同时进行。
- 推荐模型工具(自备)：胶水，水口剪刀，长咀钳，刀片，锉刀，镊子钳，钻，剪刀，瞬间快干胶。
- 软布同砂纸同时也是所需工具。
- 请使用塑料胶水和油漆，模型内不含。
- 谨防小孩吸吮塑料零件，或者将塑料袋套在头上，制作时应将套材远离小孩接触。
- 本产品不适合14岁以下没有经验的模型爱好者。

水贴纸的使用:

1. 从水贴纸上下剪下印花;
2. 将印花放入温水中浸10秒, 然后放在干净布上.
3. 拿着印花纸板将印花移到模型上;
4. 手指蘸水将印花移到适当的位置;
5. 用软布轻压印花直至水干, 汽泡消失.

DECAL APPLICATION:

1. Cut decals from sheet as needed
2. Dip the decal in warm water for about 10 seconds and then place on soft clean cloth.
3. Hold the decal backing sheet edge and gently slide the decal onto the model in its proper position.
4. While still wet, decal can be adjusted for better fit on model by dampening it gently with your finger.
5. When placed in the proper position, gently press decal down with a soft cloth until excess water and air bubbles are gone.
6. Allow decal to dry completely before handling model



使用强力胶
Cyanoacrylate glue



配重
Weight



钻孔
Make hole



切除
Cut / Remove



先装
Install it first



贴纸
Decal



锉平
File / Sand



选择
Option



不涂胶水
No cement



弯曲
Bend



填补
Repair

部品图 Parts

《船体ZA》 Hull ZA

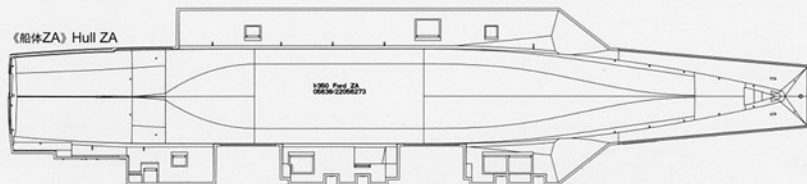

《飞行甲板 ZB》 Flight deck ZB

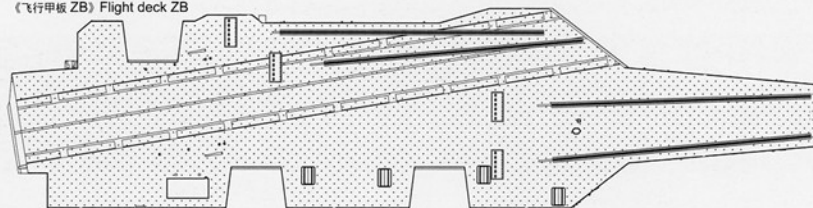

《机库甲板 ZC2》 Hangar deck ZC2

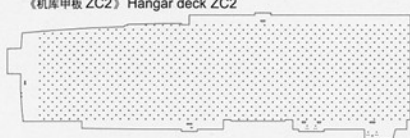

《机库甲板 ZC1》 Hangar deck ZC1

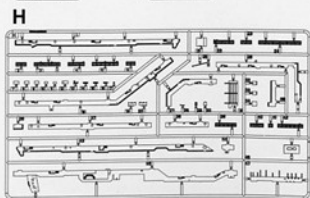
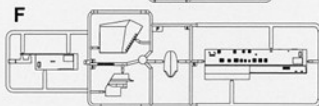
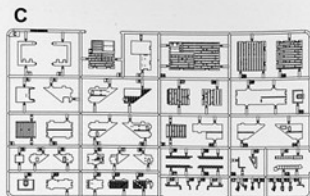
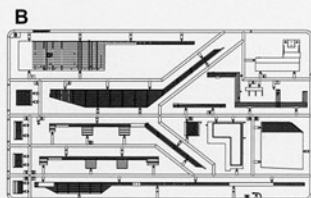
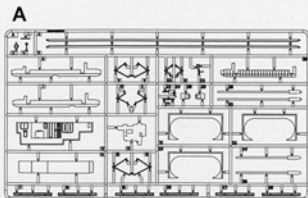
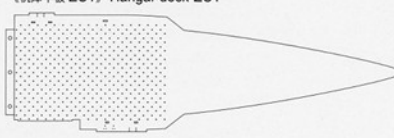

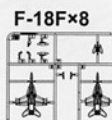
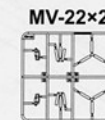
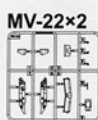
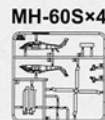
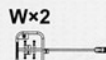
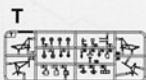
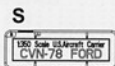
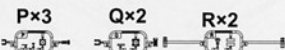
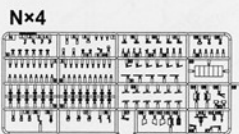
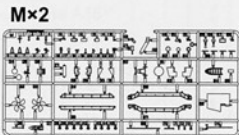
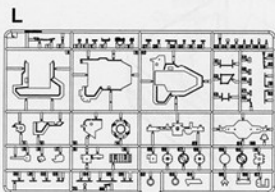
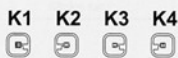

座架 Stand



蚀刻片 PE (A)



蚀刻片 PE (B)



蚀刻片 PE (C)



蚀刻片 PE (D) x2



蚀刻片 PE (E)



(水贴)
Decal

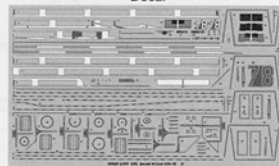

A

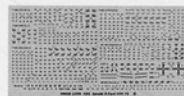

B

1

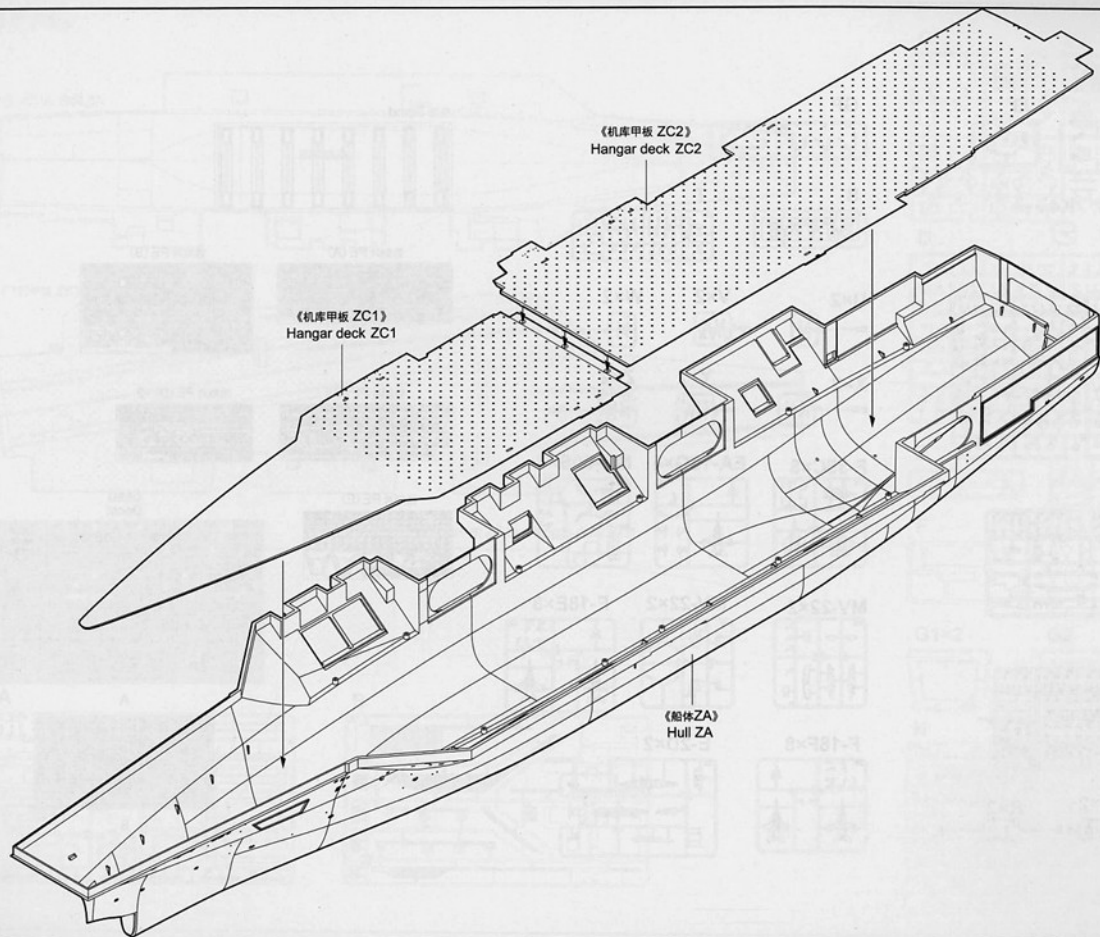

2

制作 2 组
Make two

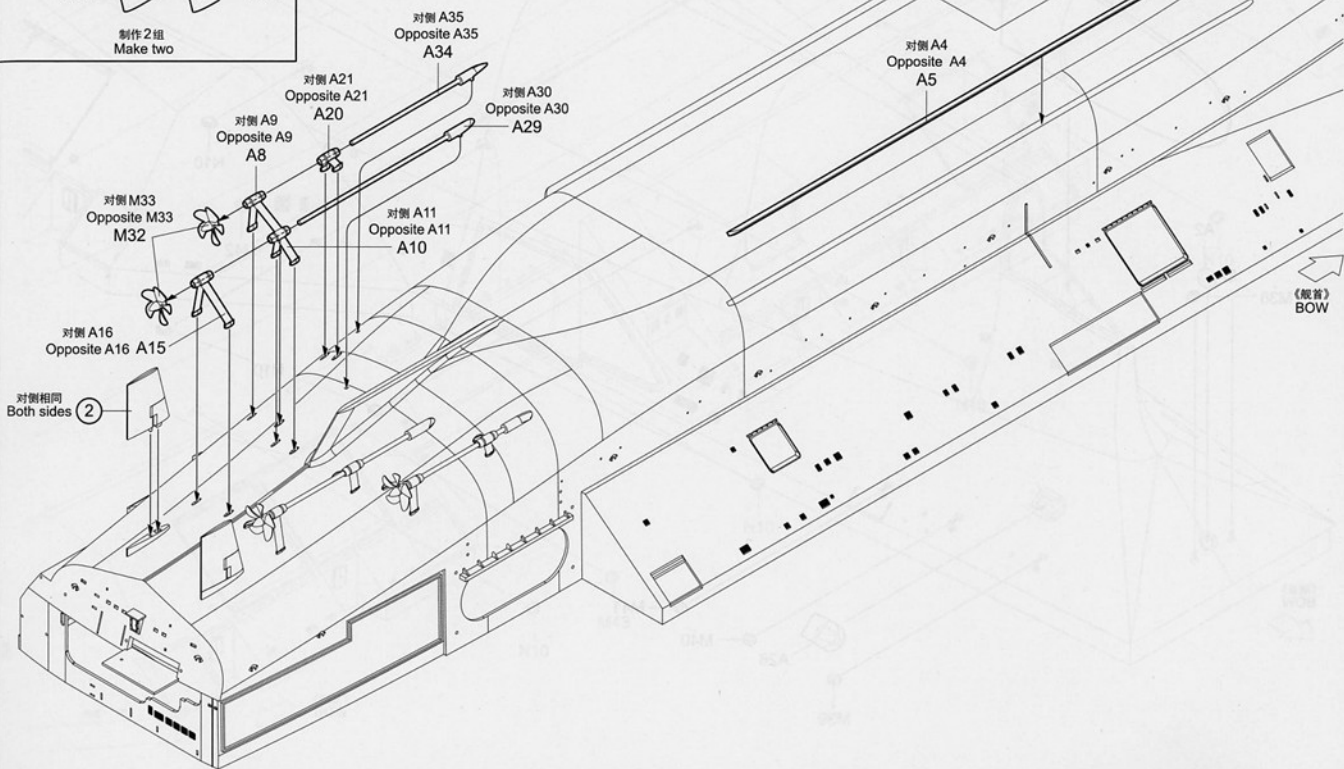
3

4

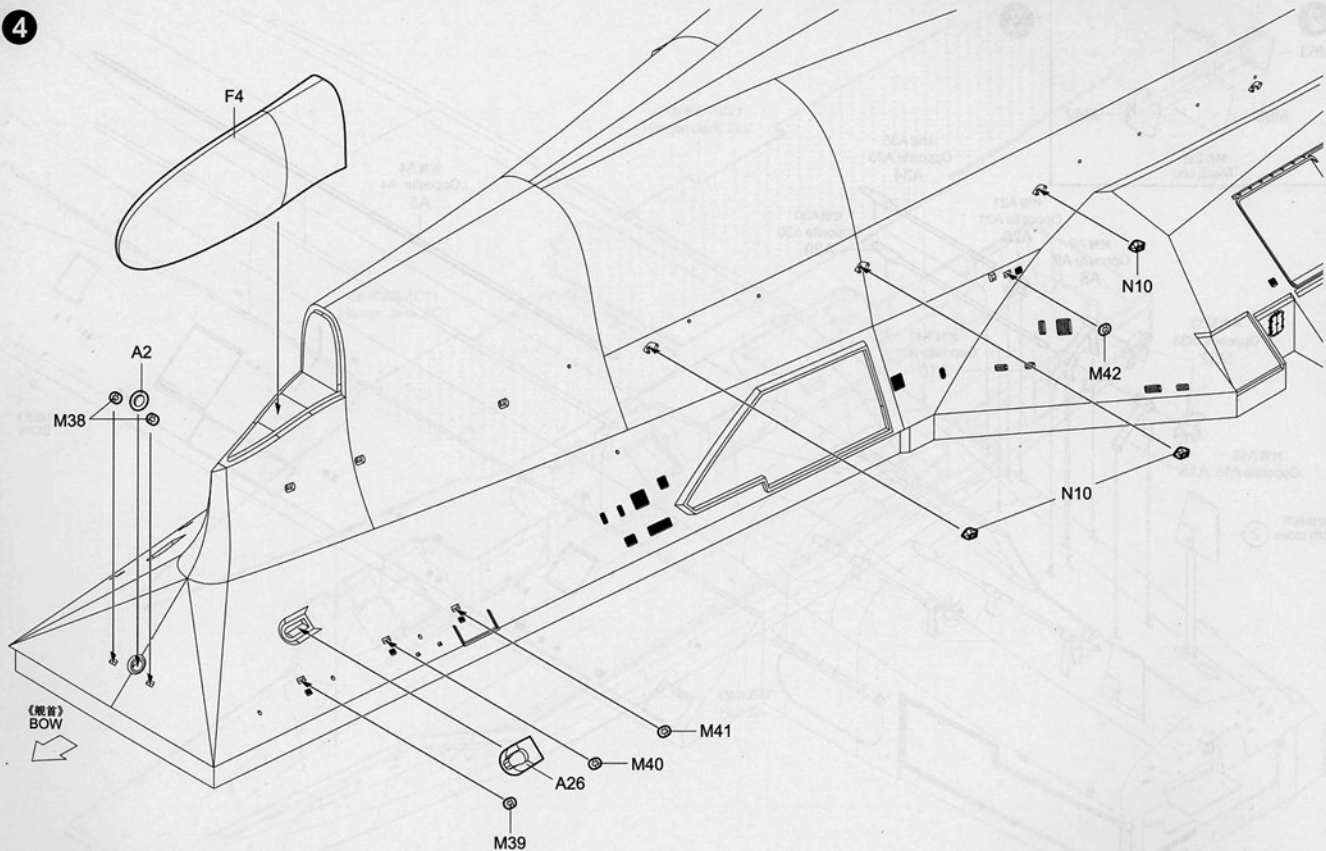

5

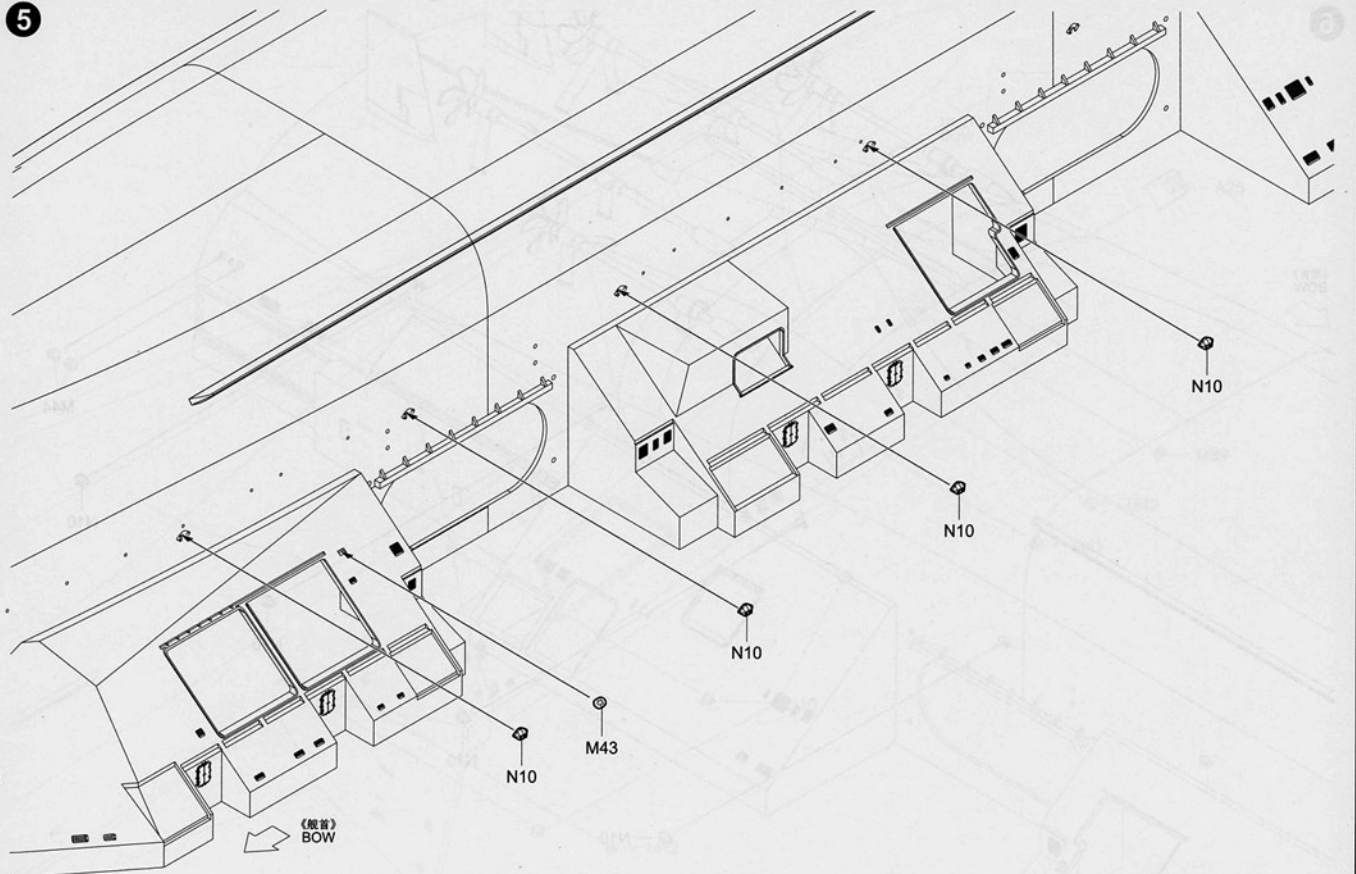

6

《観音》
BOW

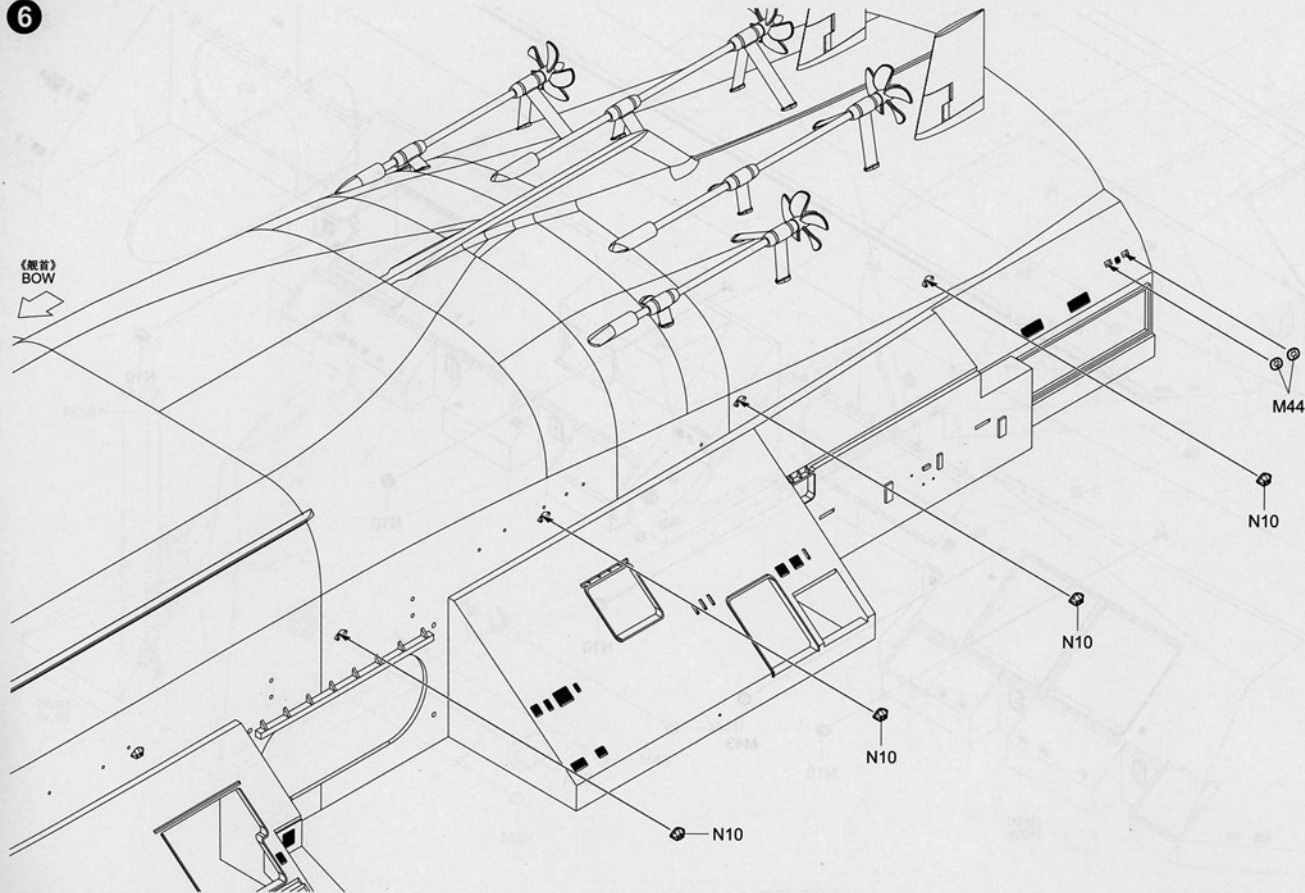

7

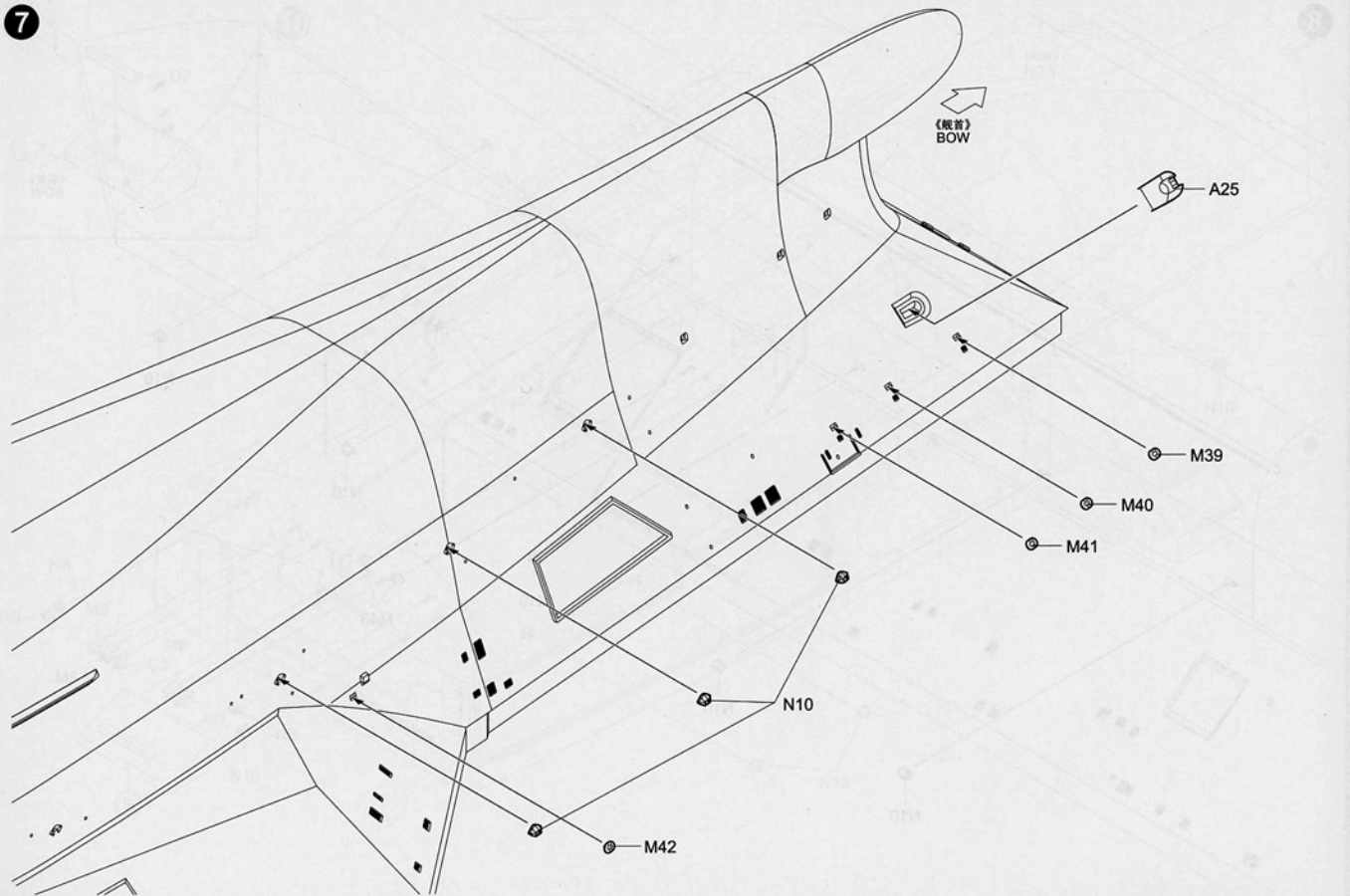

8

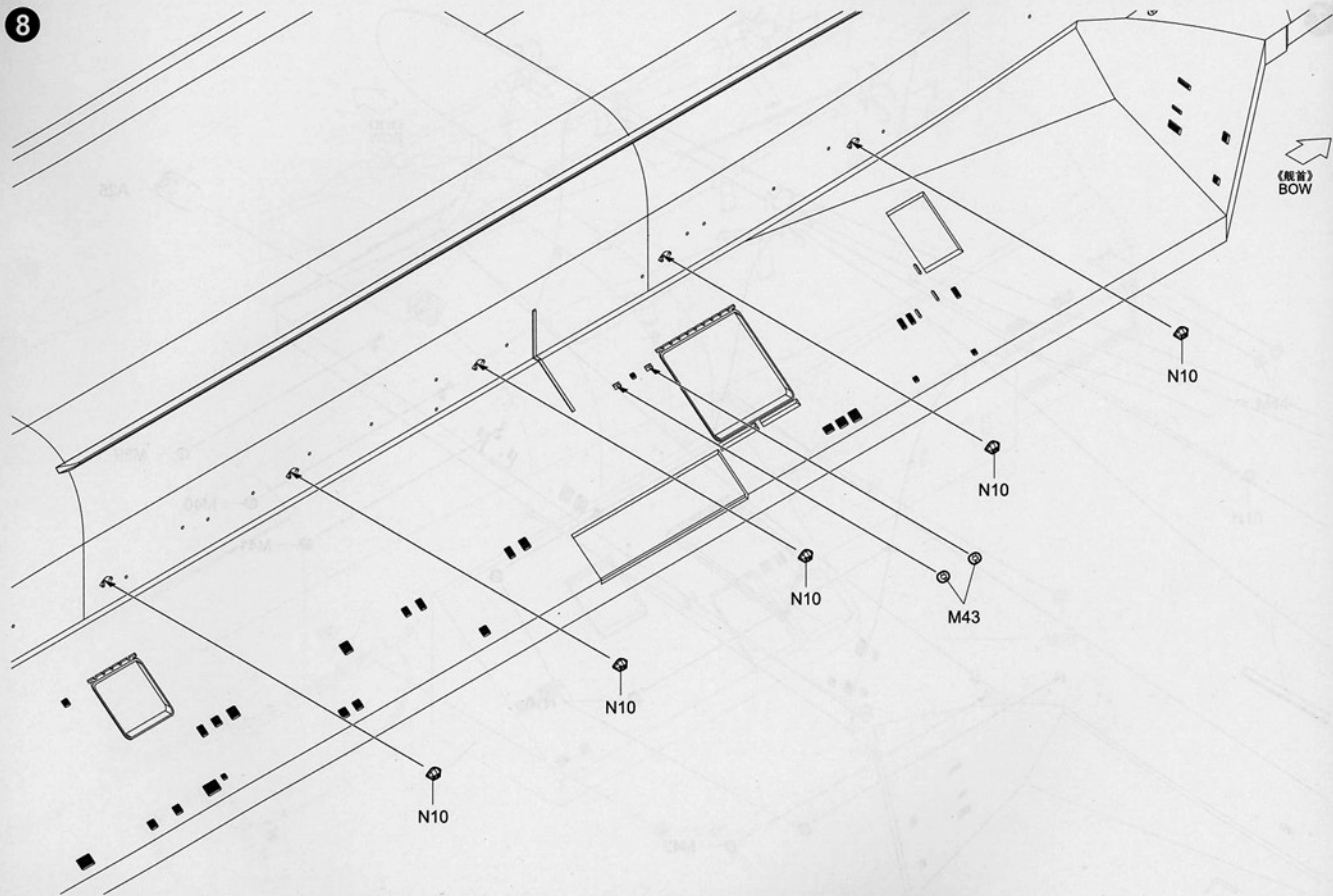

9

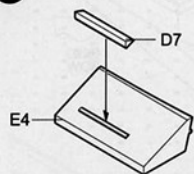

10

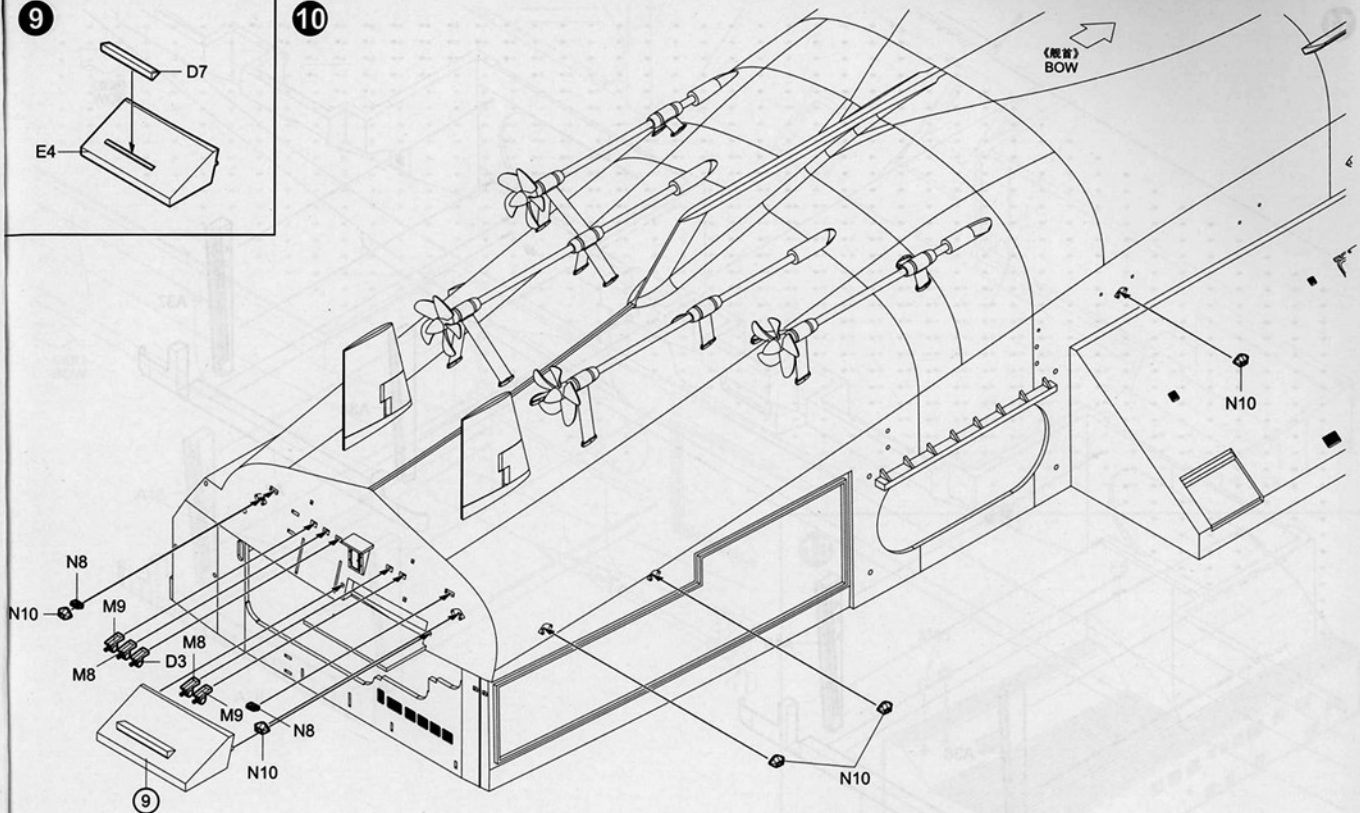

12

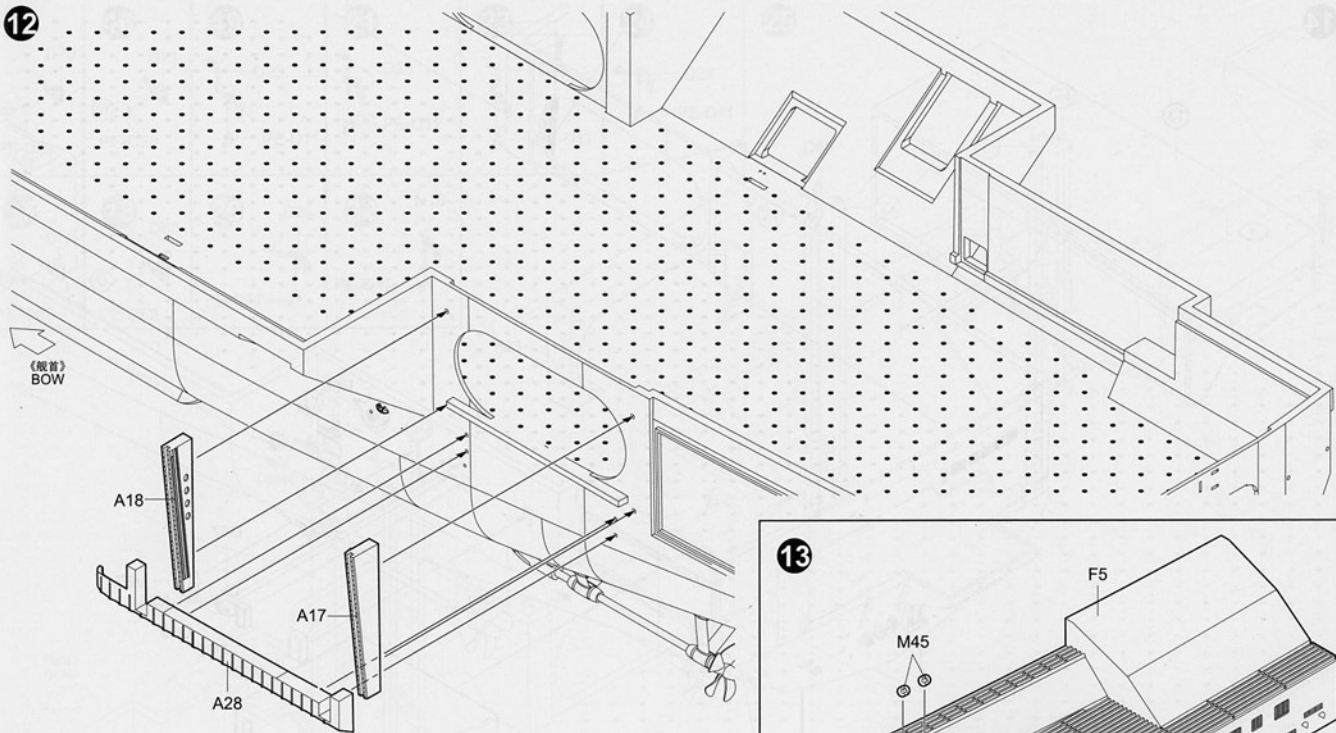

13

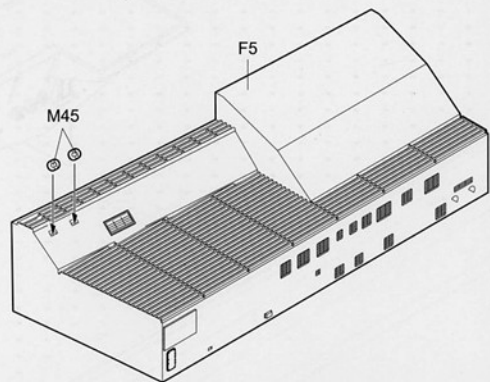

14

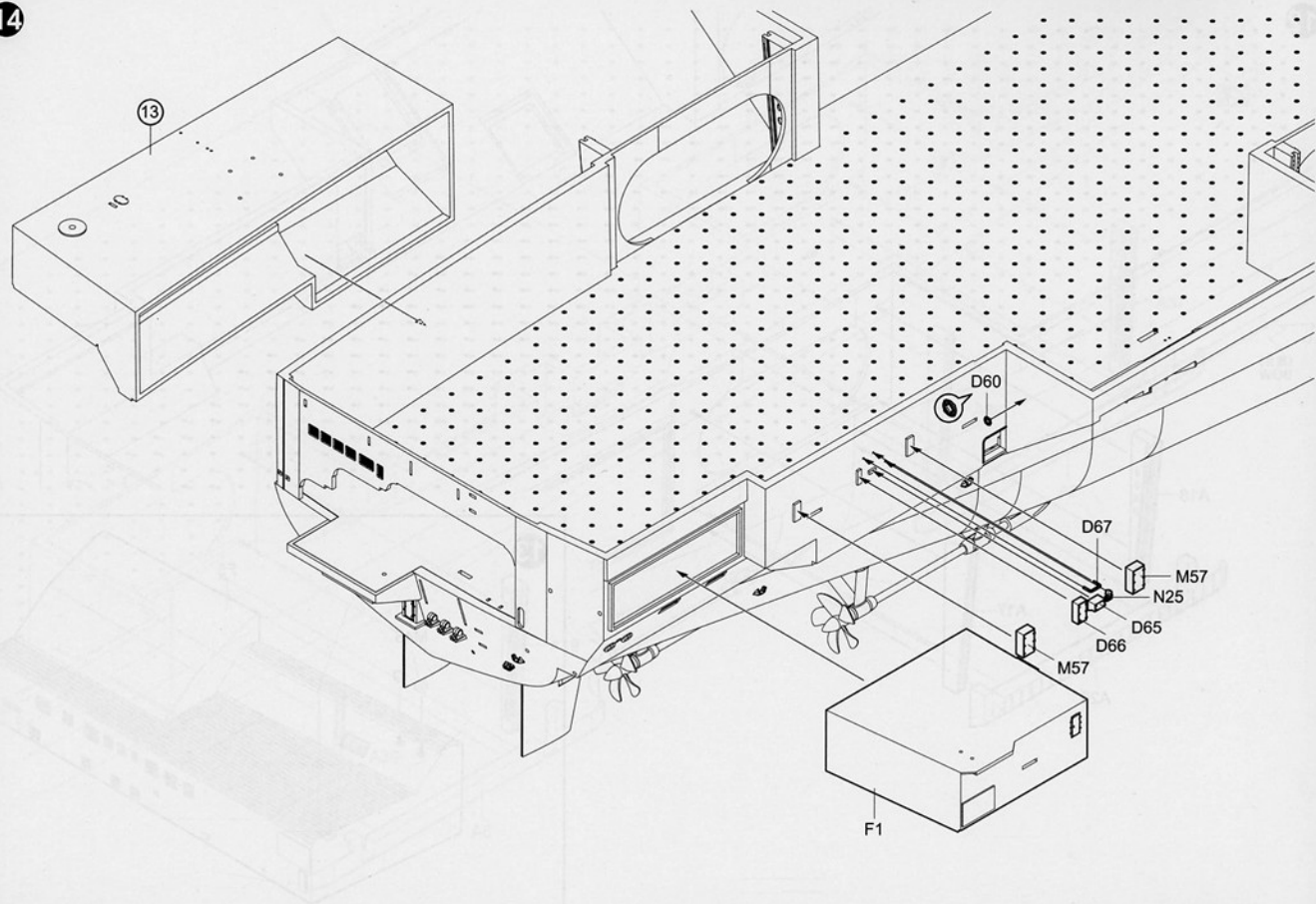

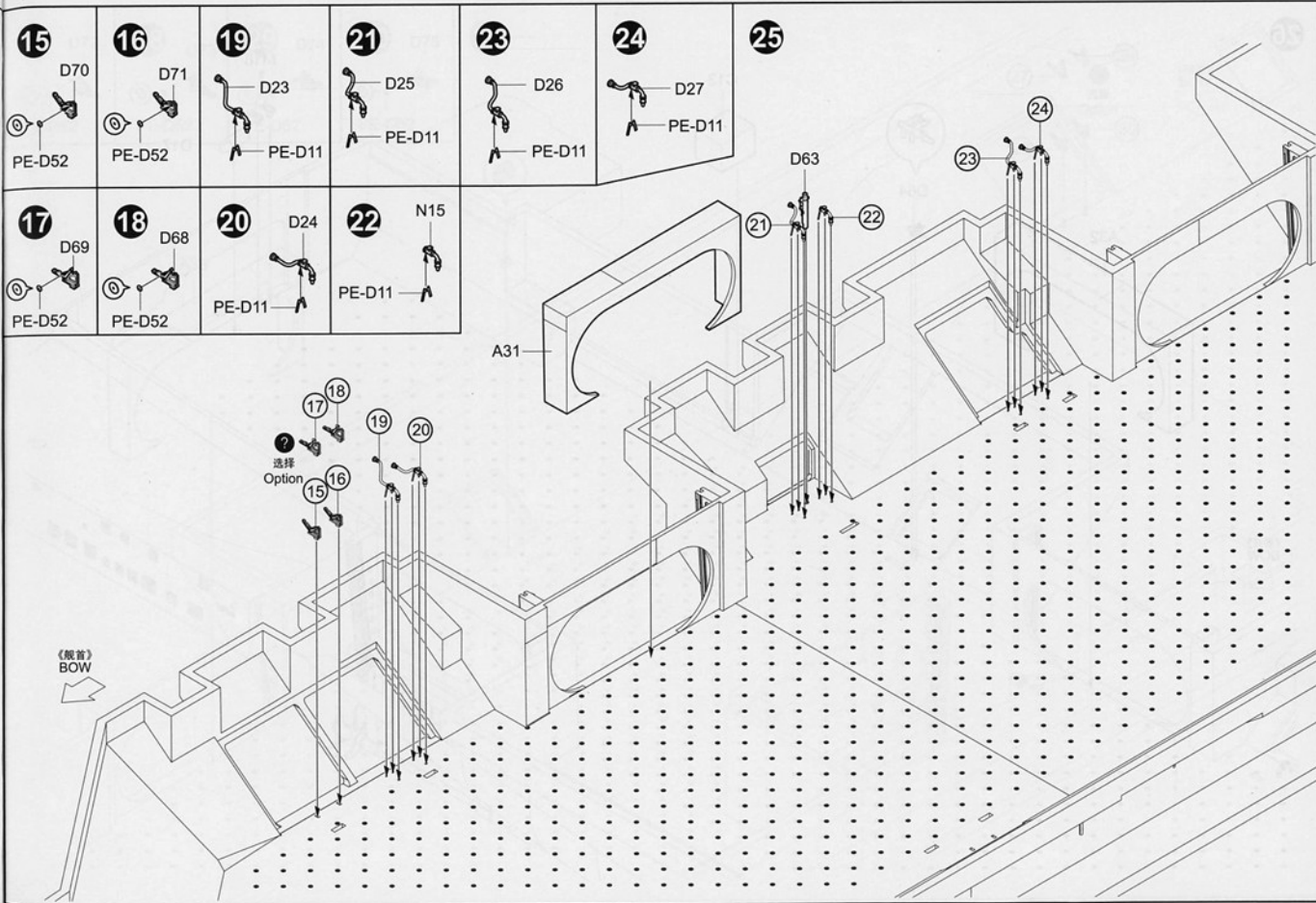

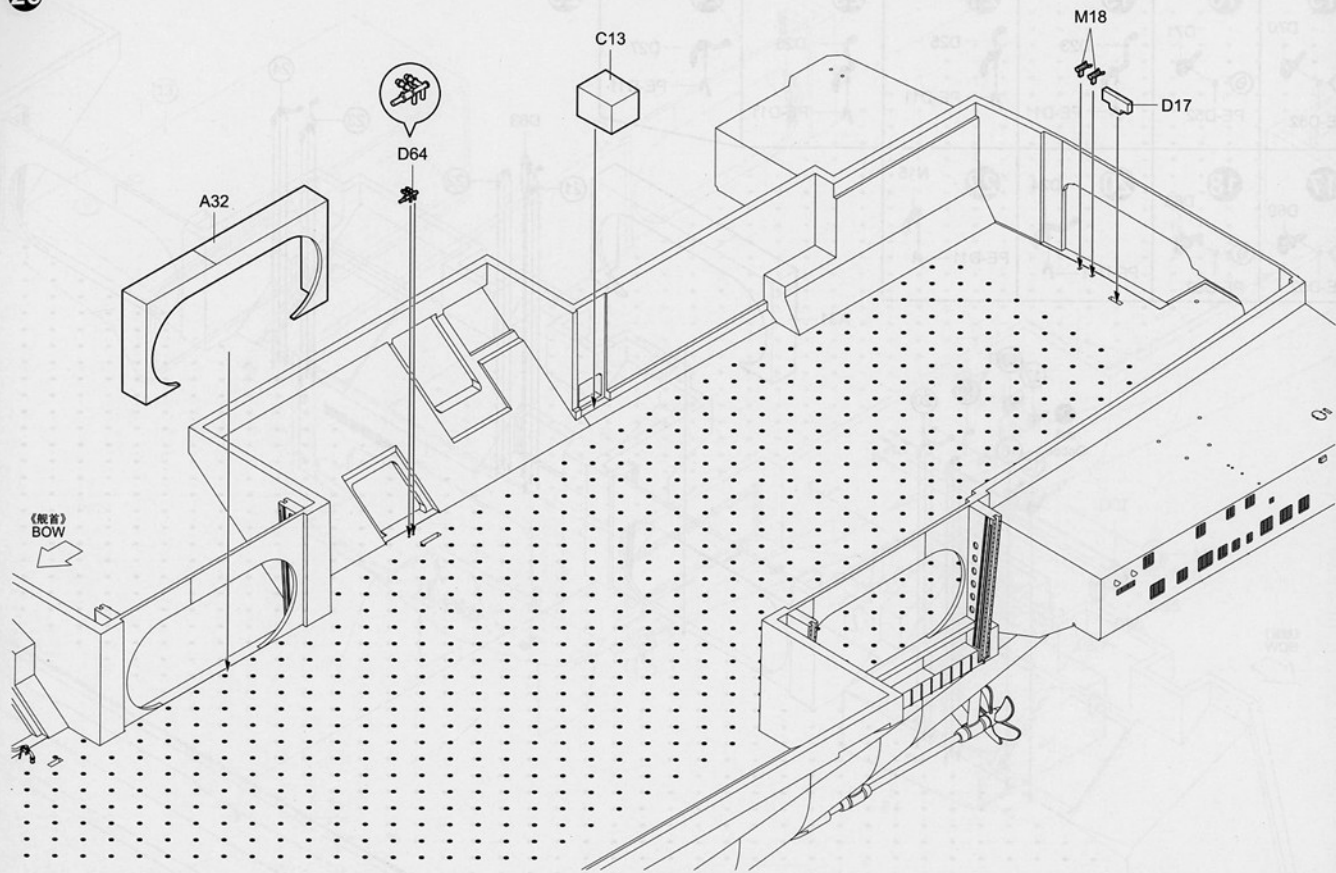

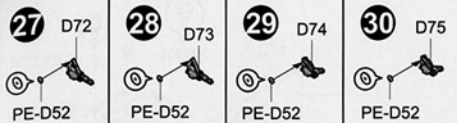

31

N8

A33

27
28
29
30
选择
Option

《原音》
BOW

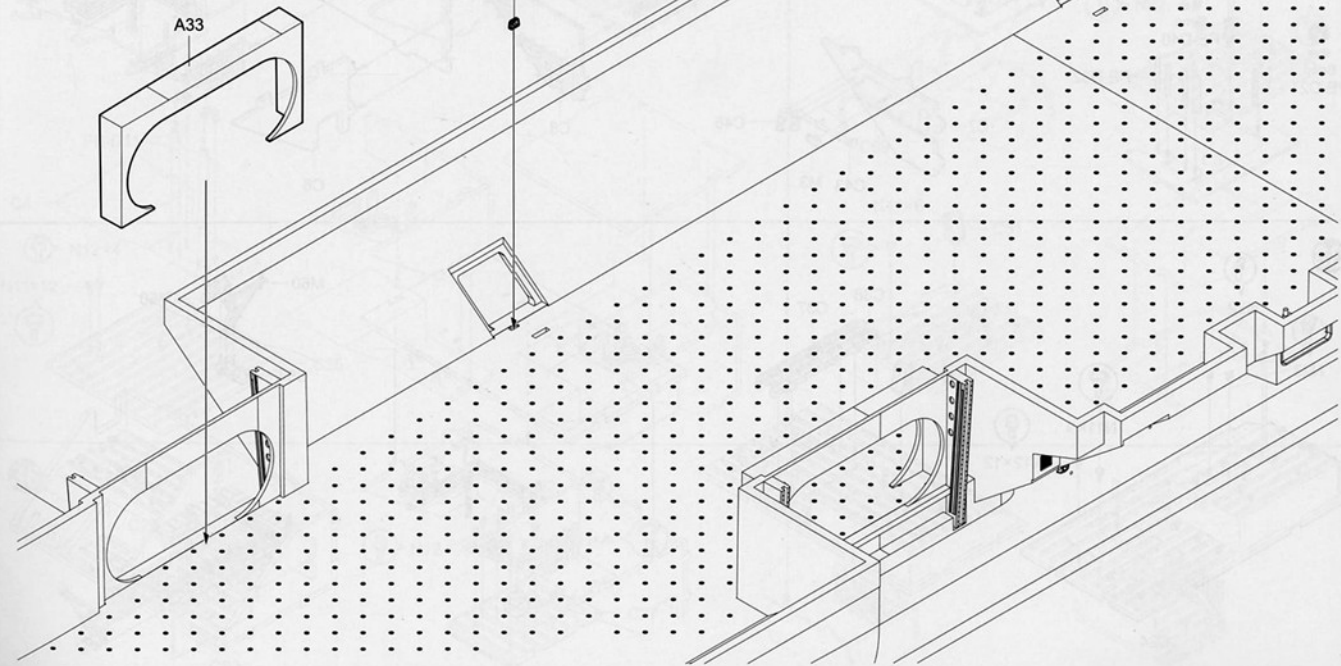

32

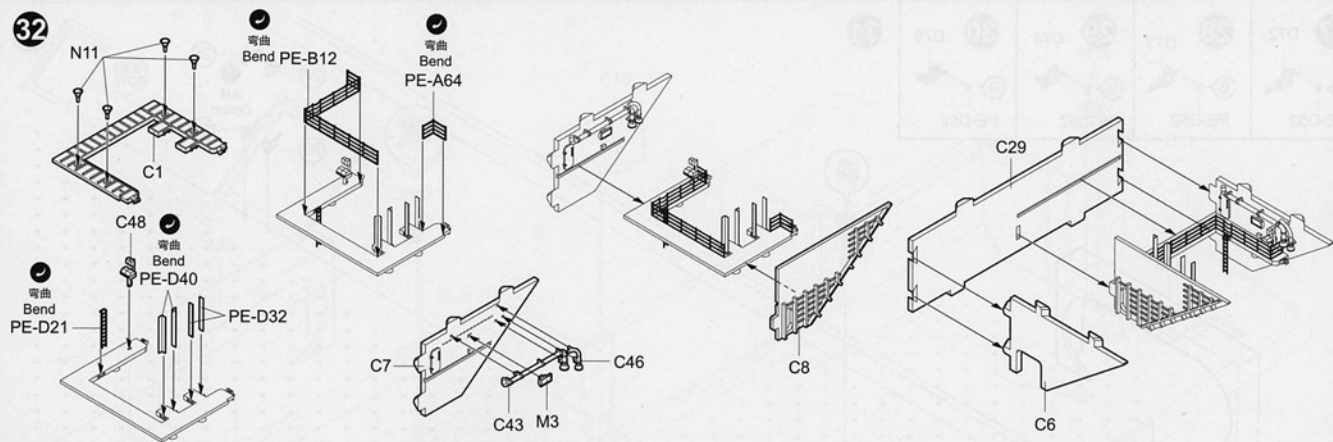

33

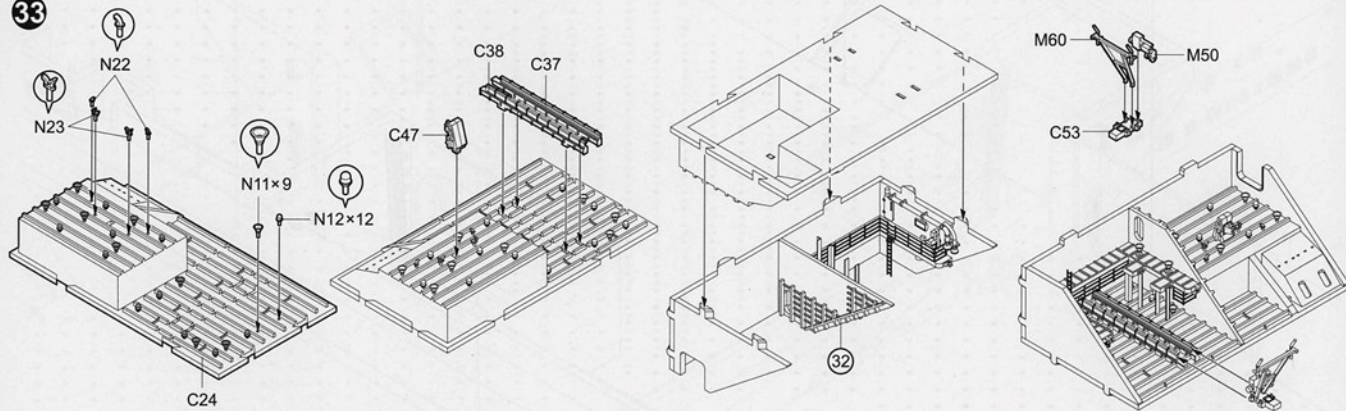

34

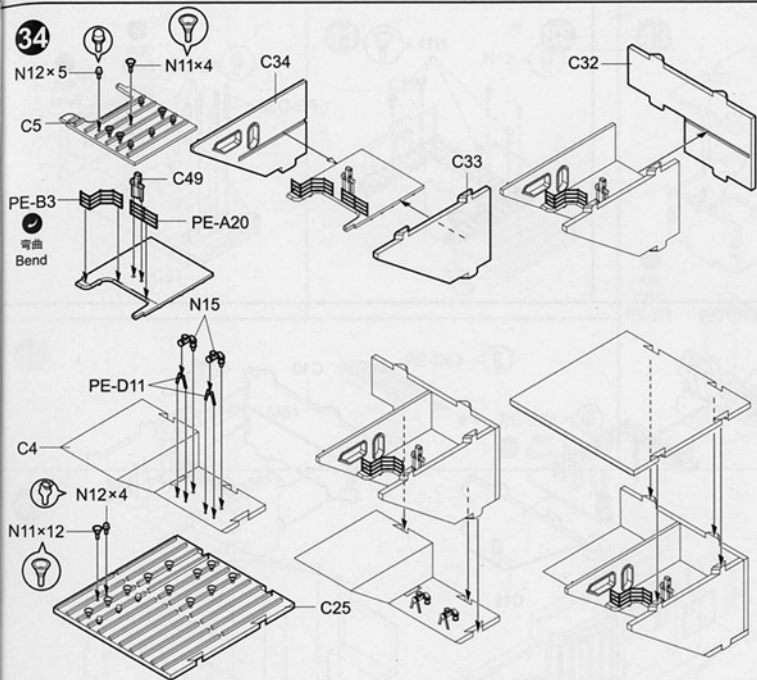

35

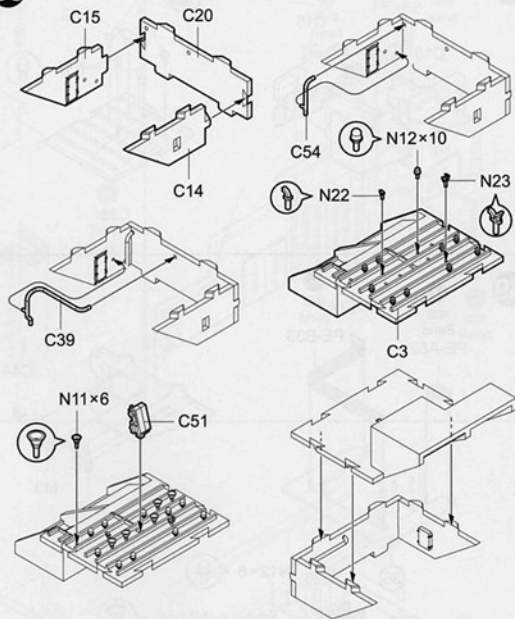

36

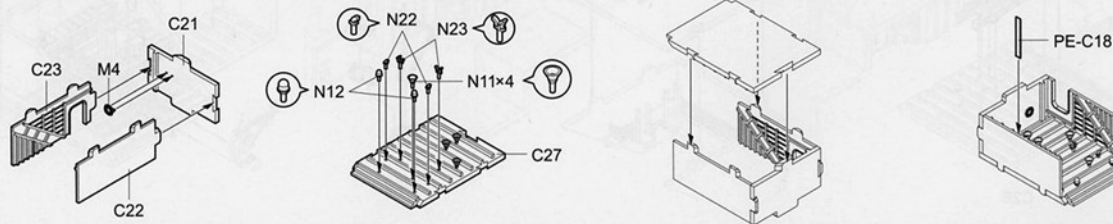

37

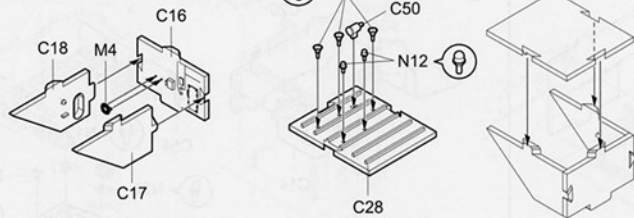

38

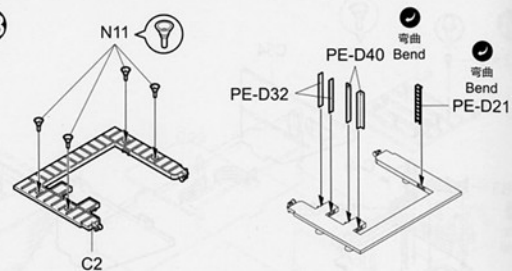

39

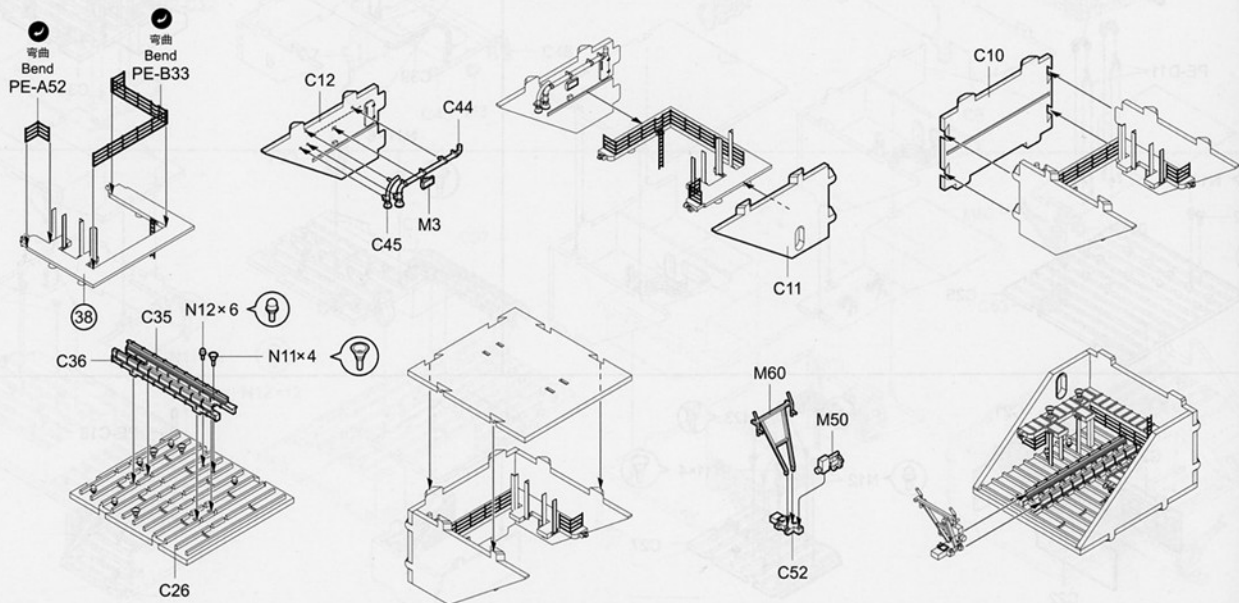

40

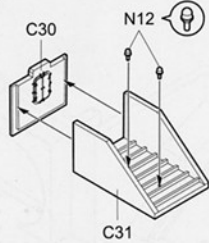

41

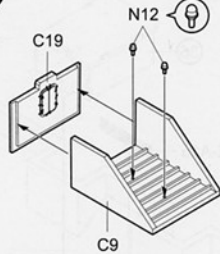

43

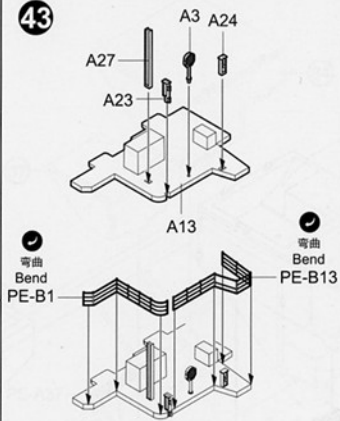

44

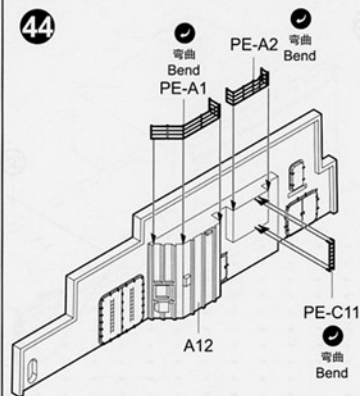

42

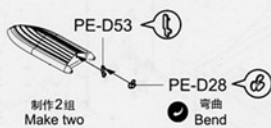

45

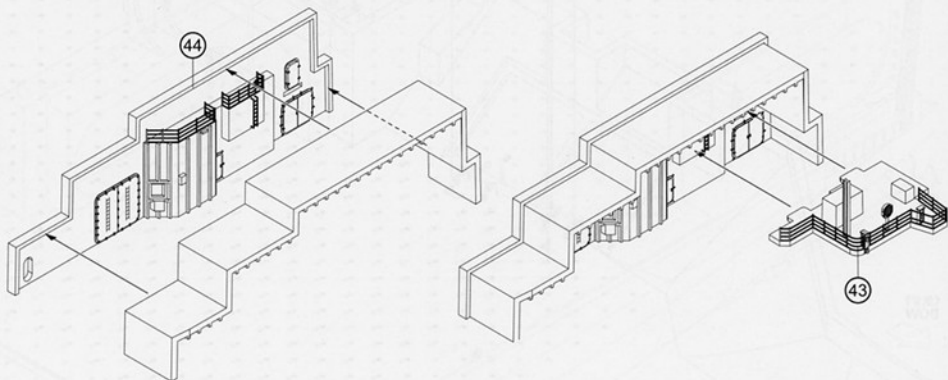
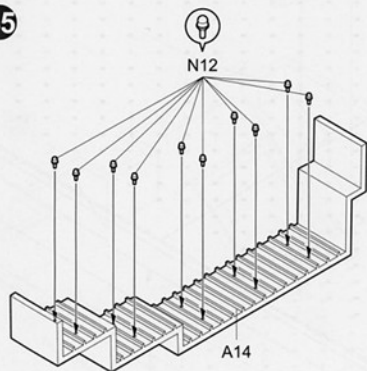

46

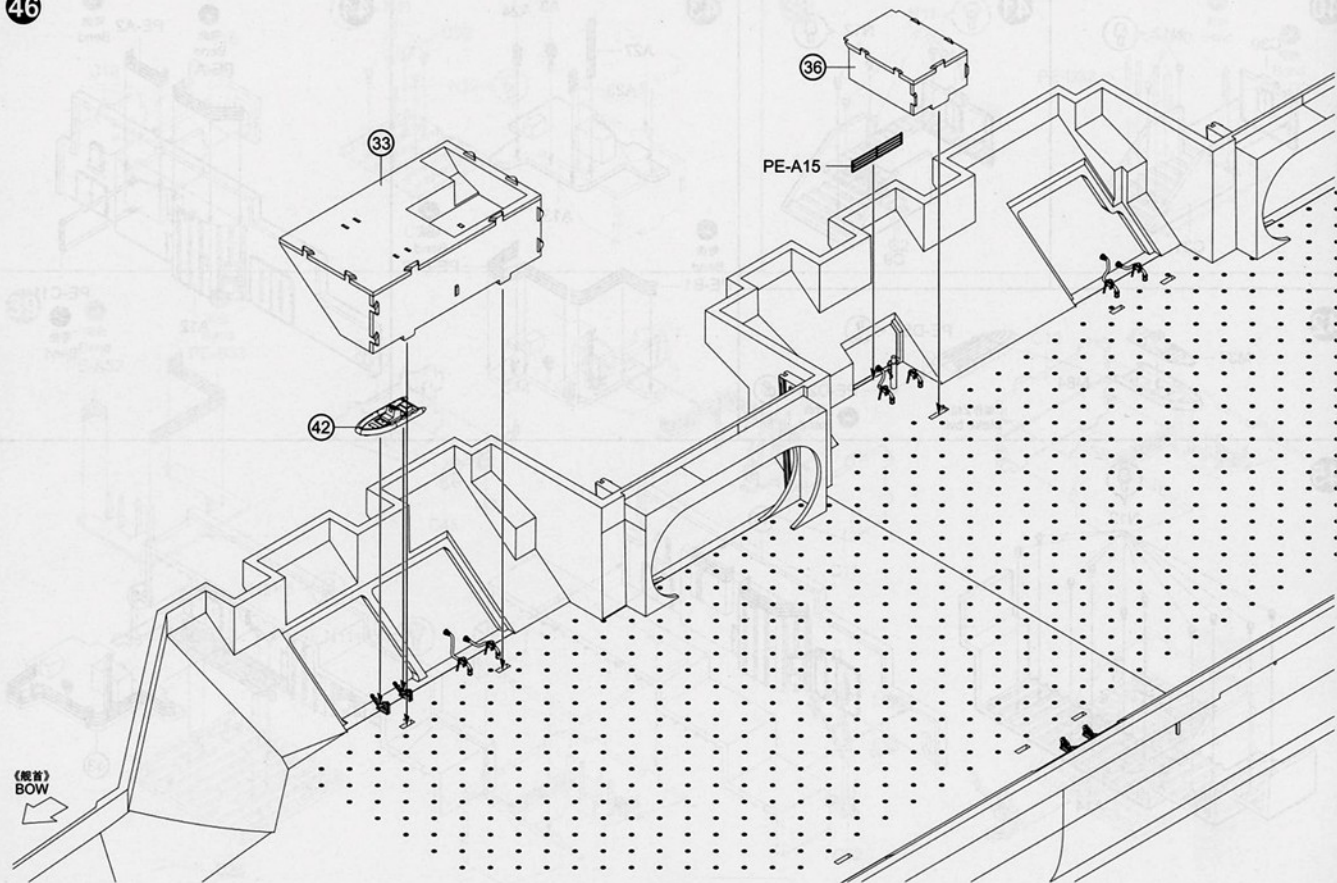

47

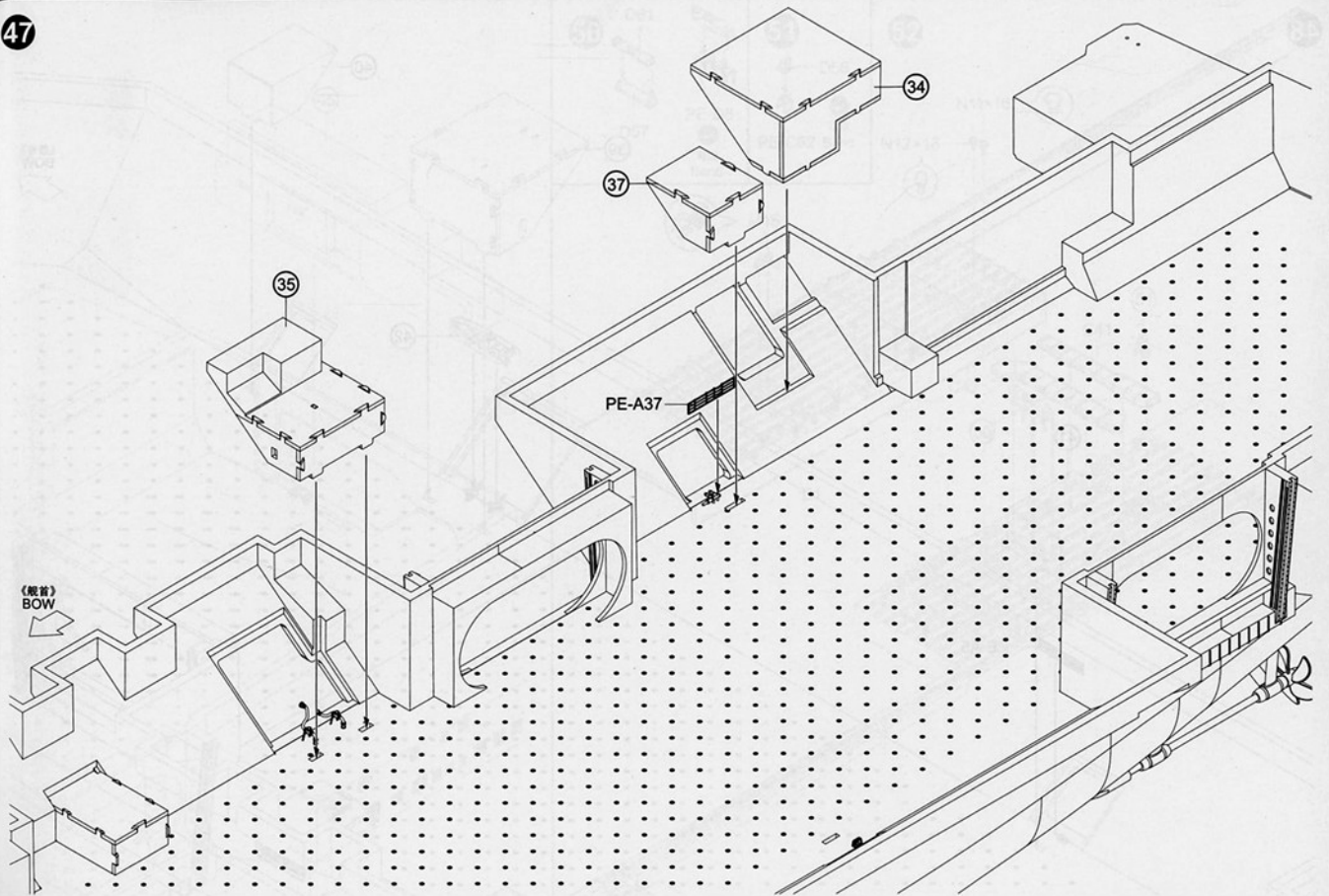

48

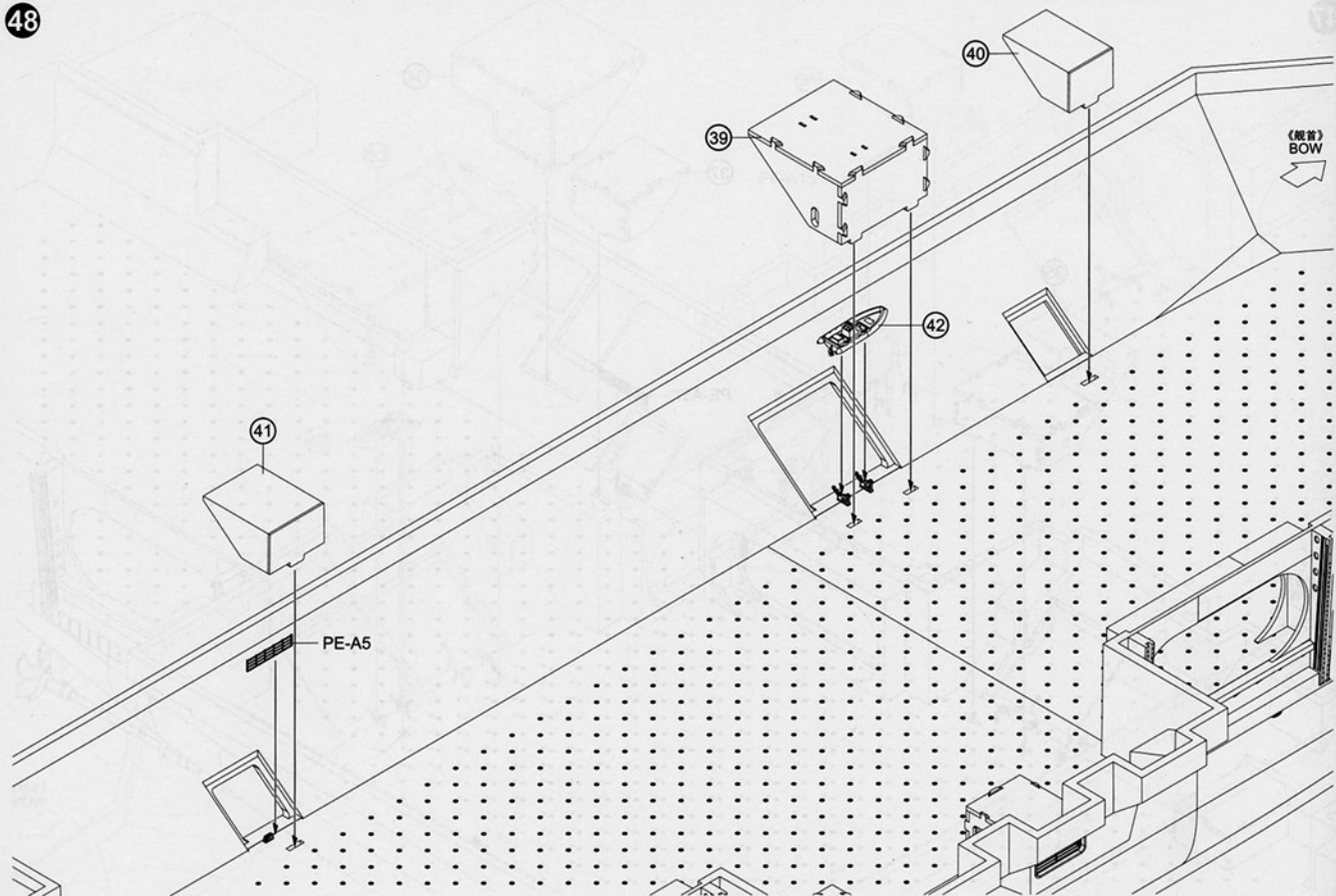

49

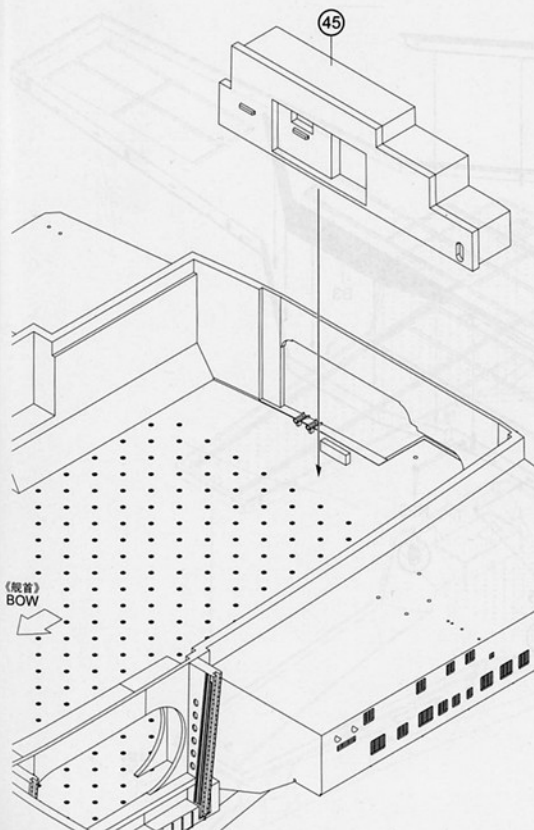

50

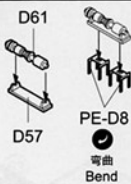

51



52

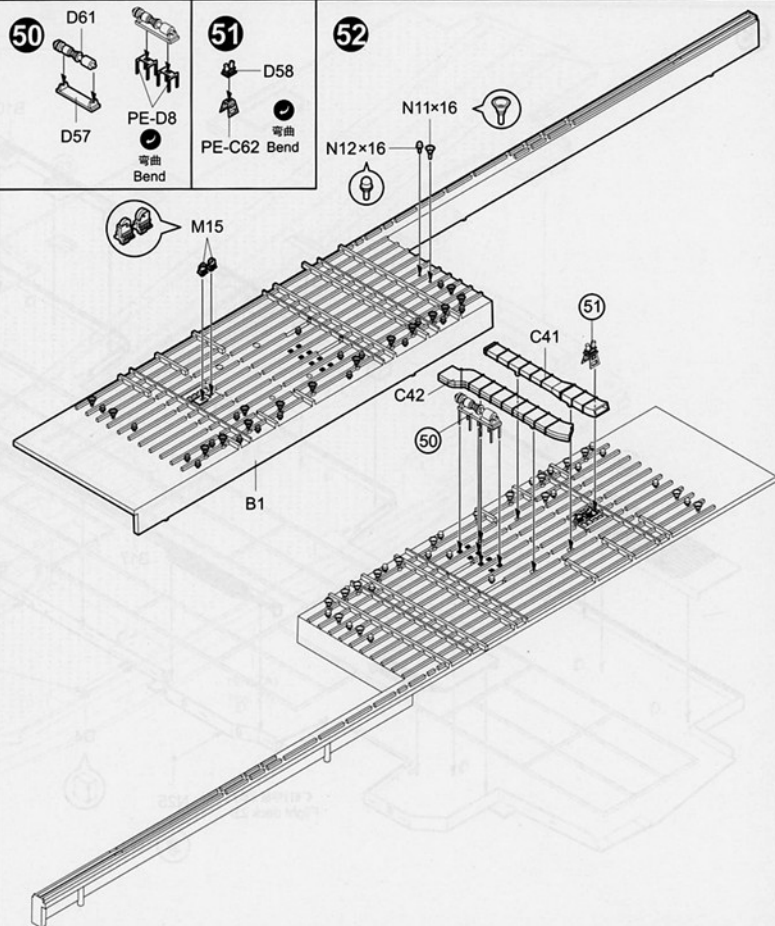

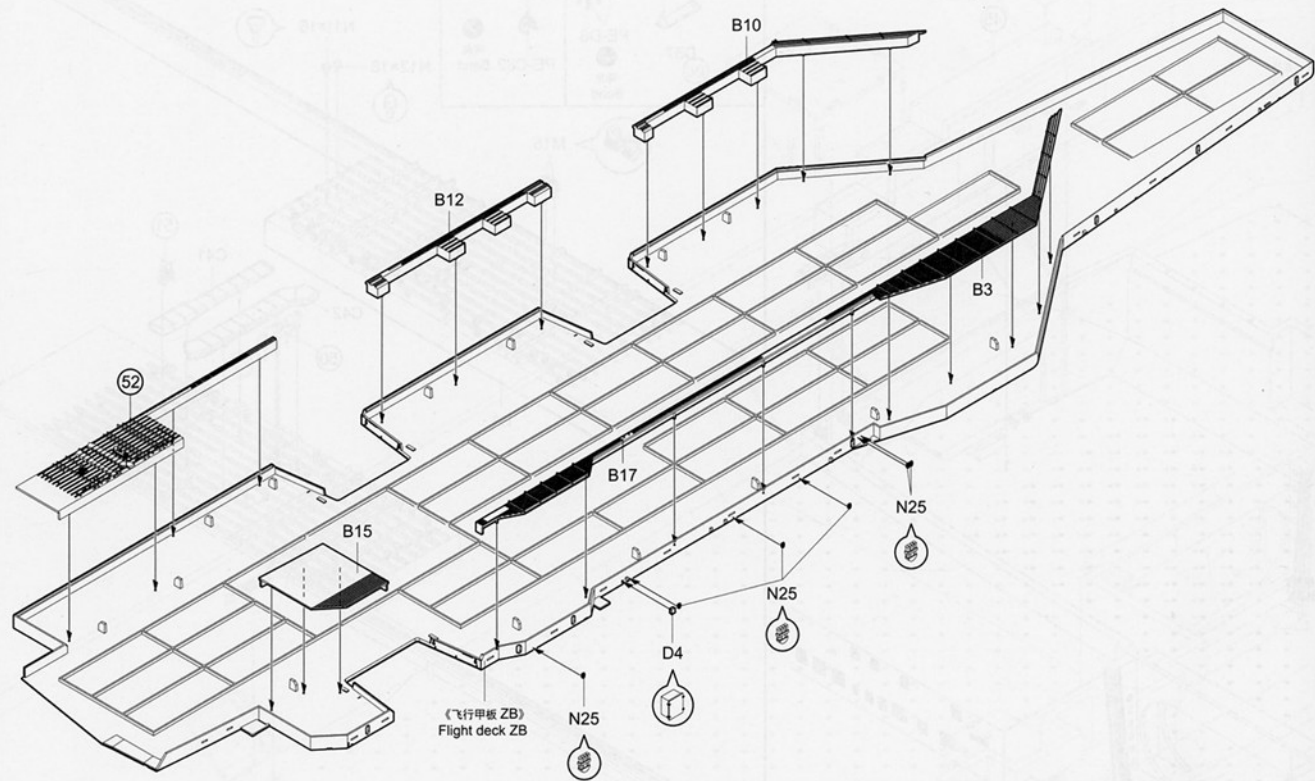

54

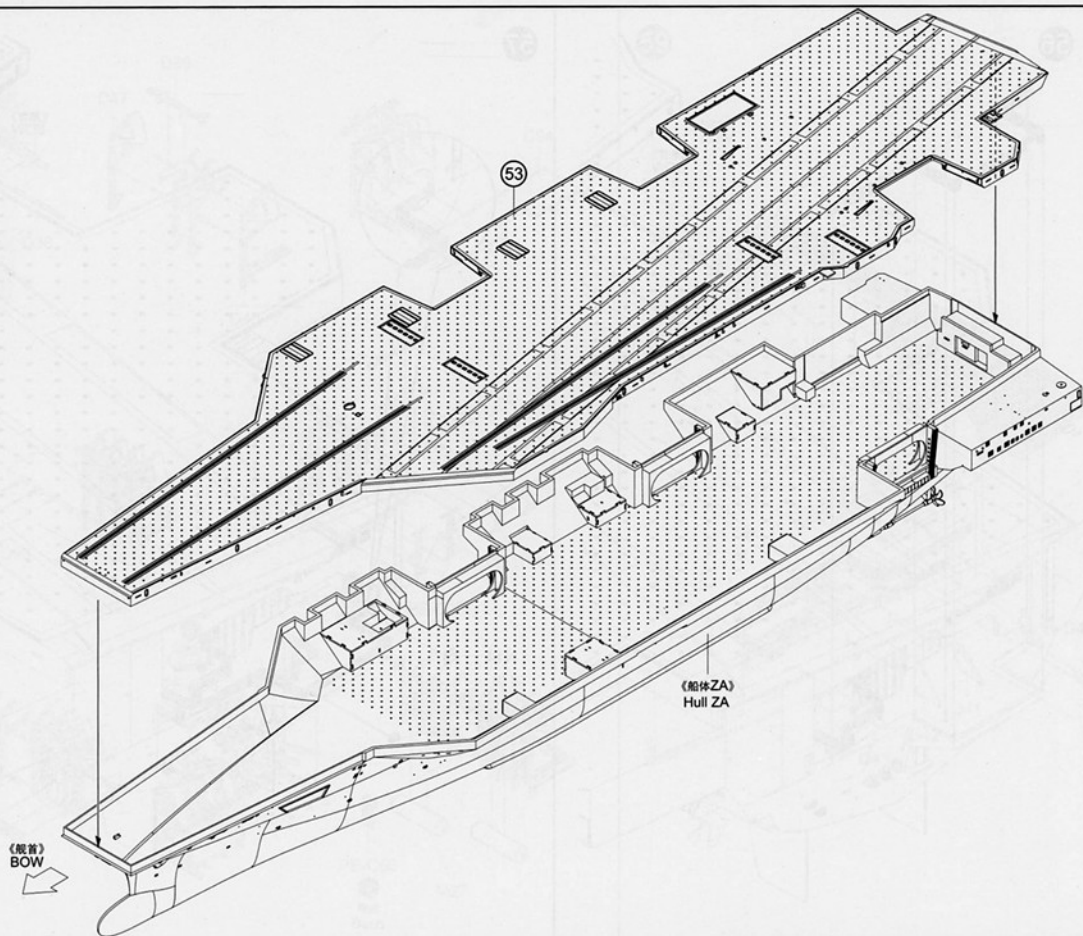

55
B18
PE-C16

56

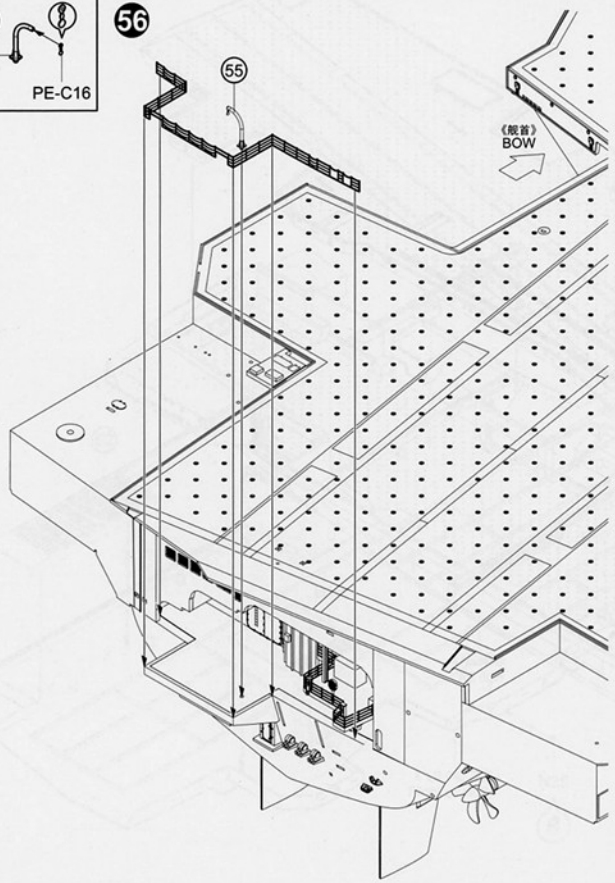

57

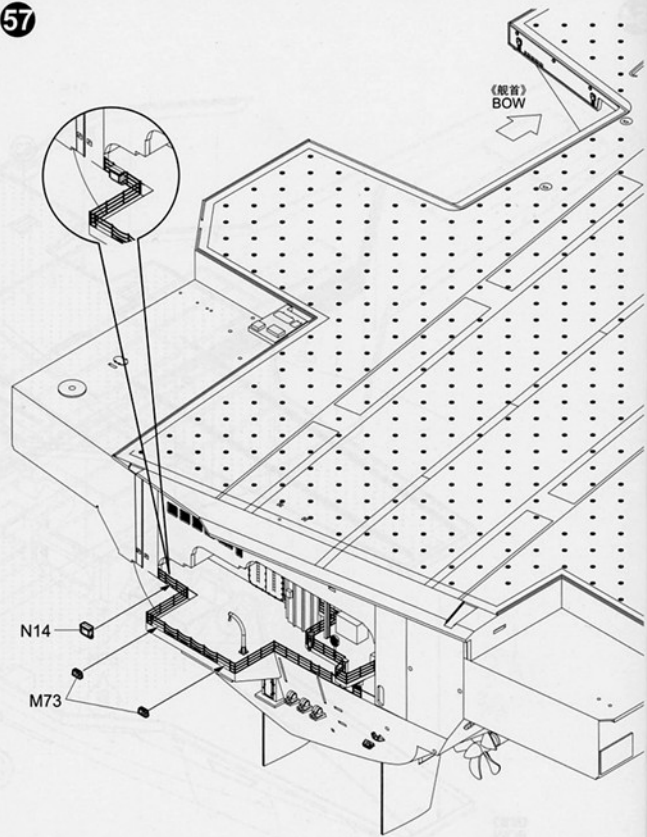

58

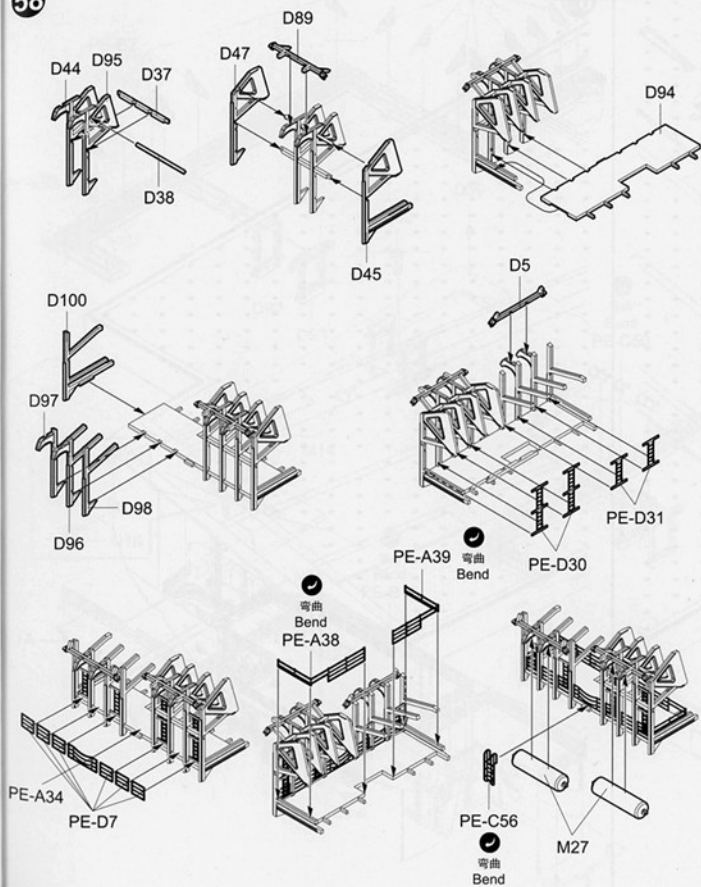

59

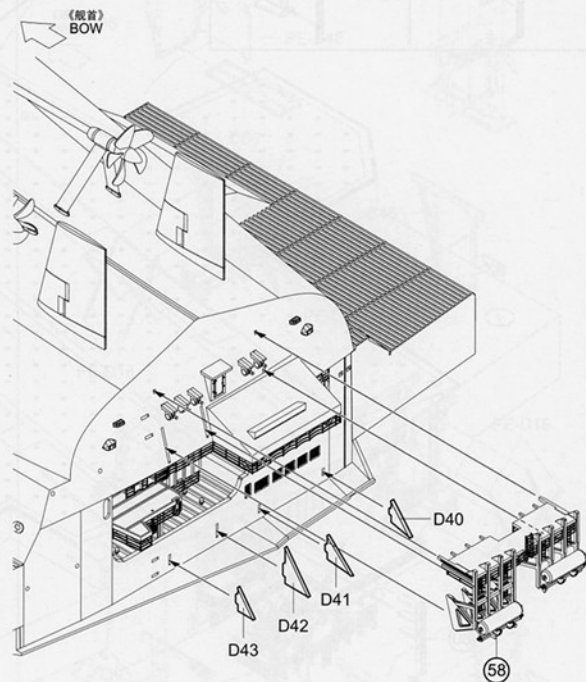

60

PE-C8

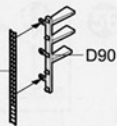
**61**

PE-C7

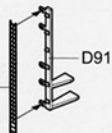
**62**

《船首》
BOW

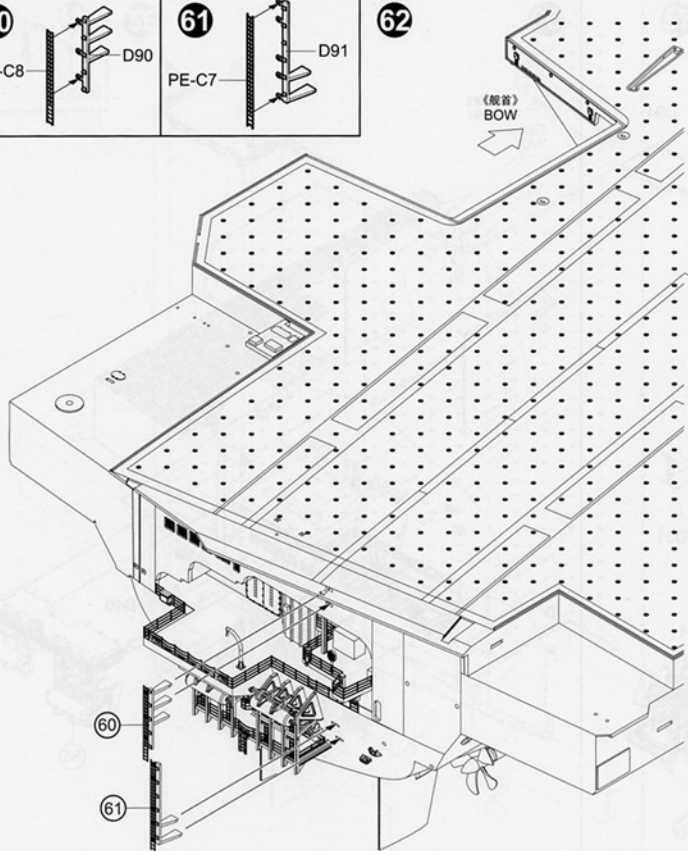
**63**

《船首》
BOW

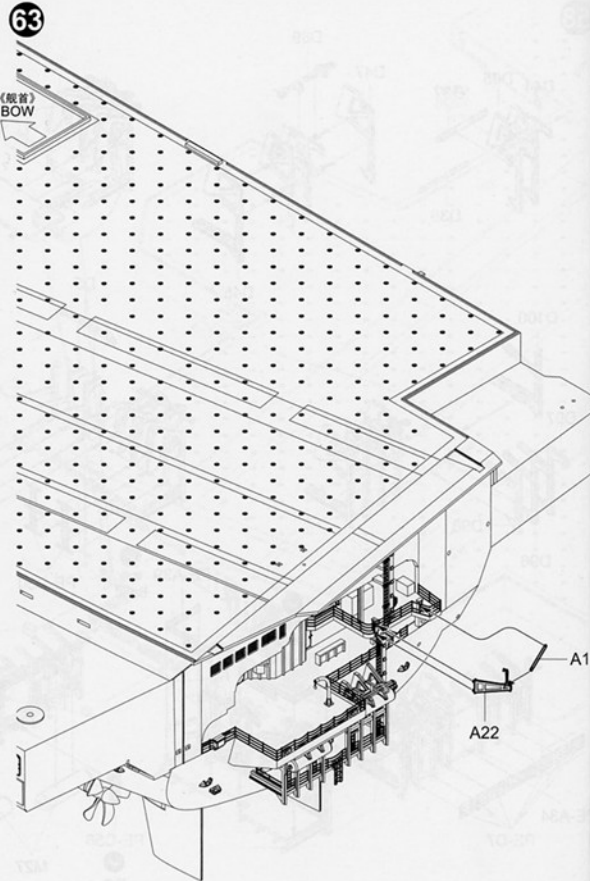

64

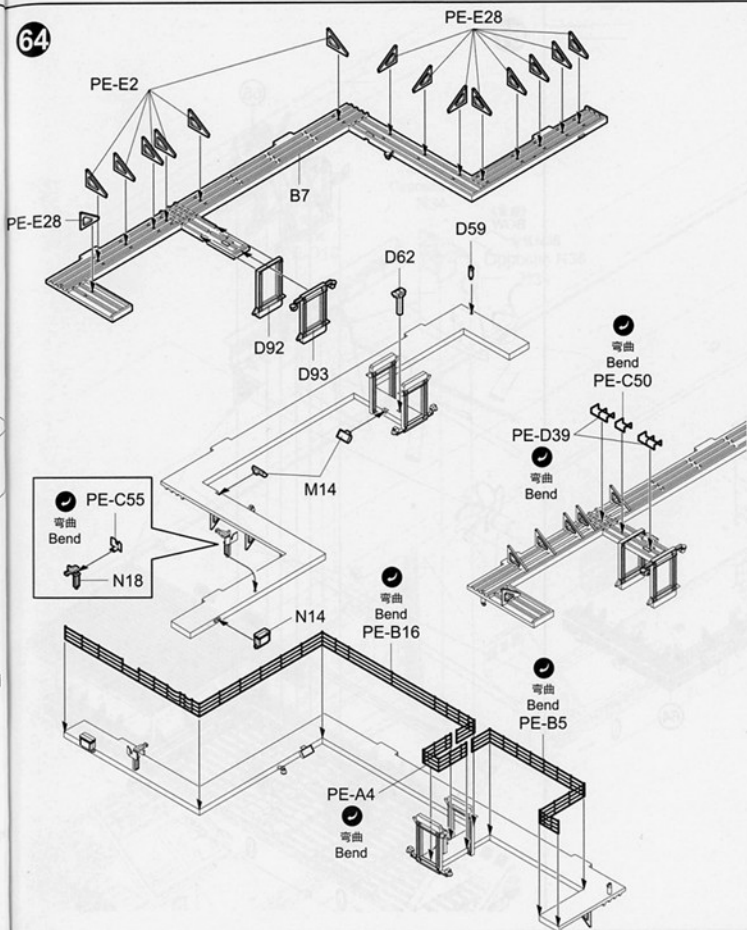

65

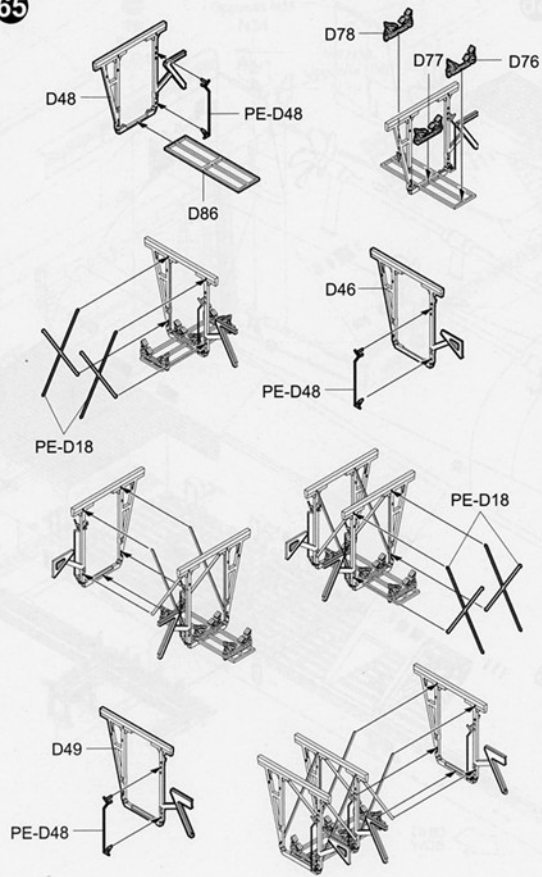

66

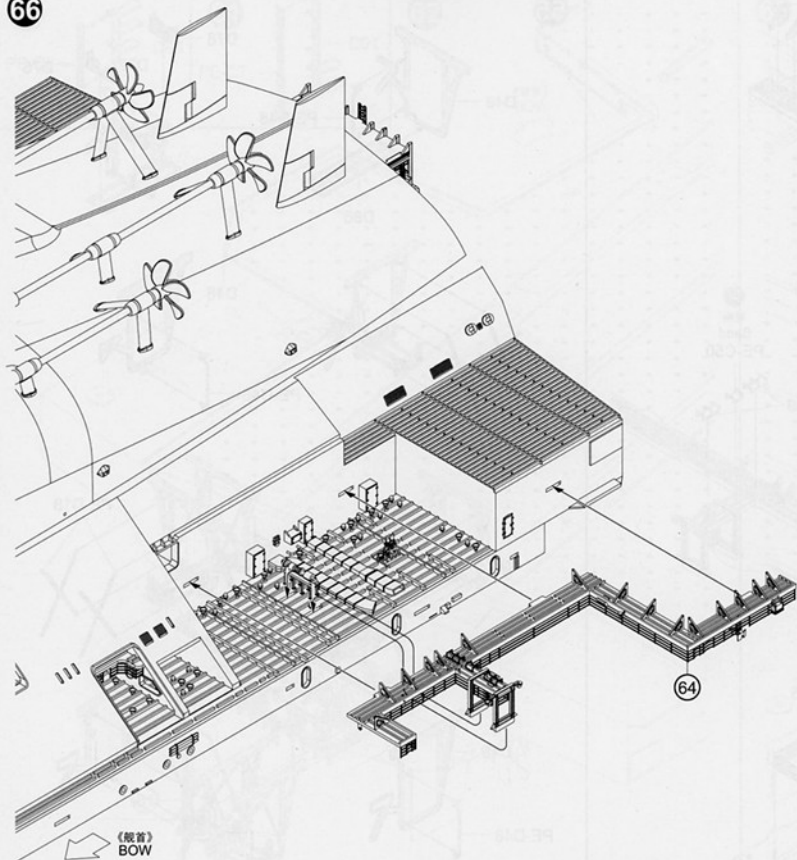

67

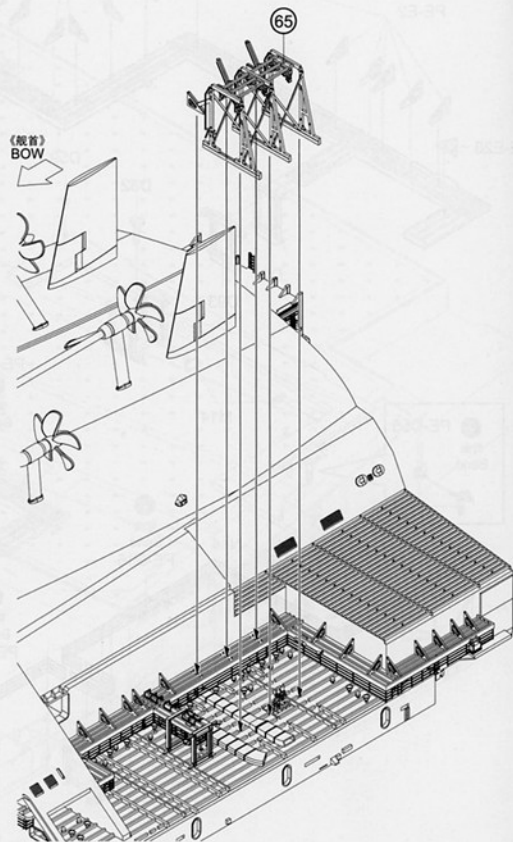

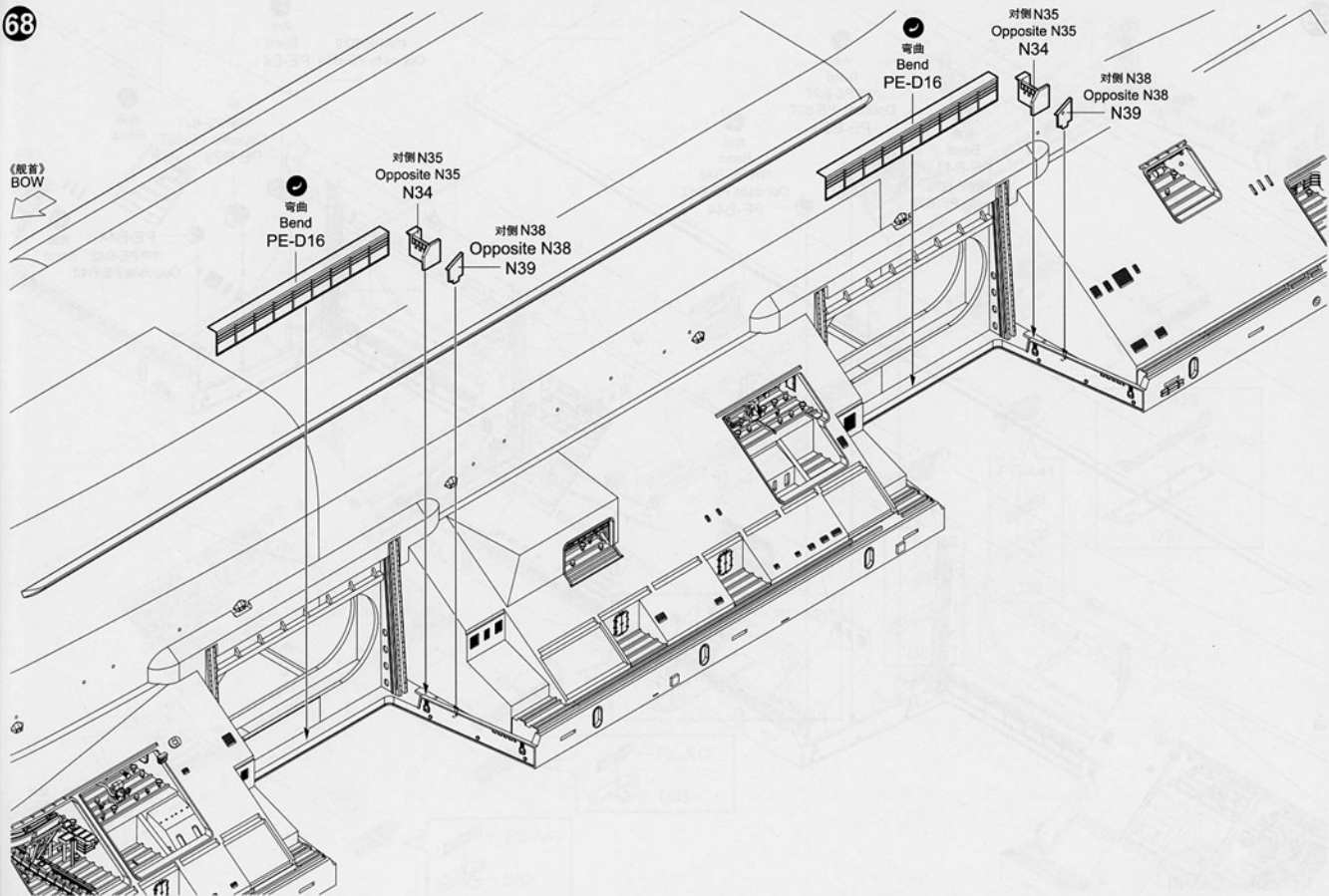
《板首》
BOW

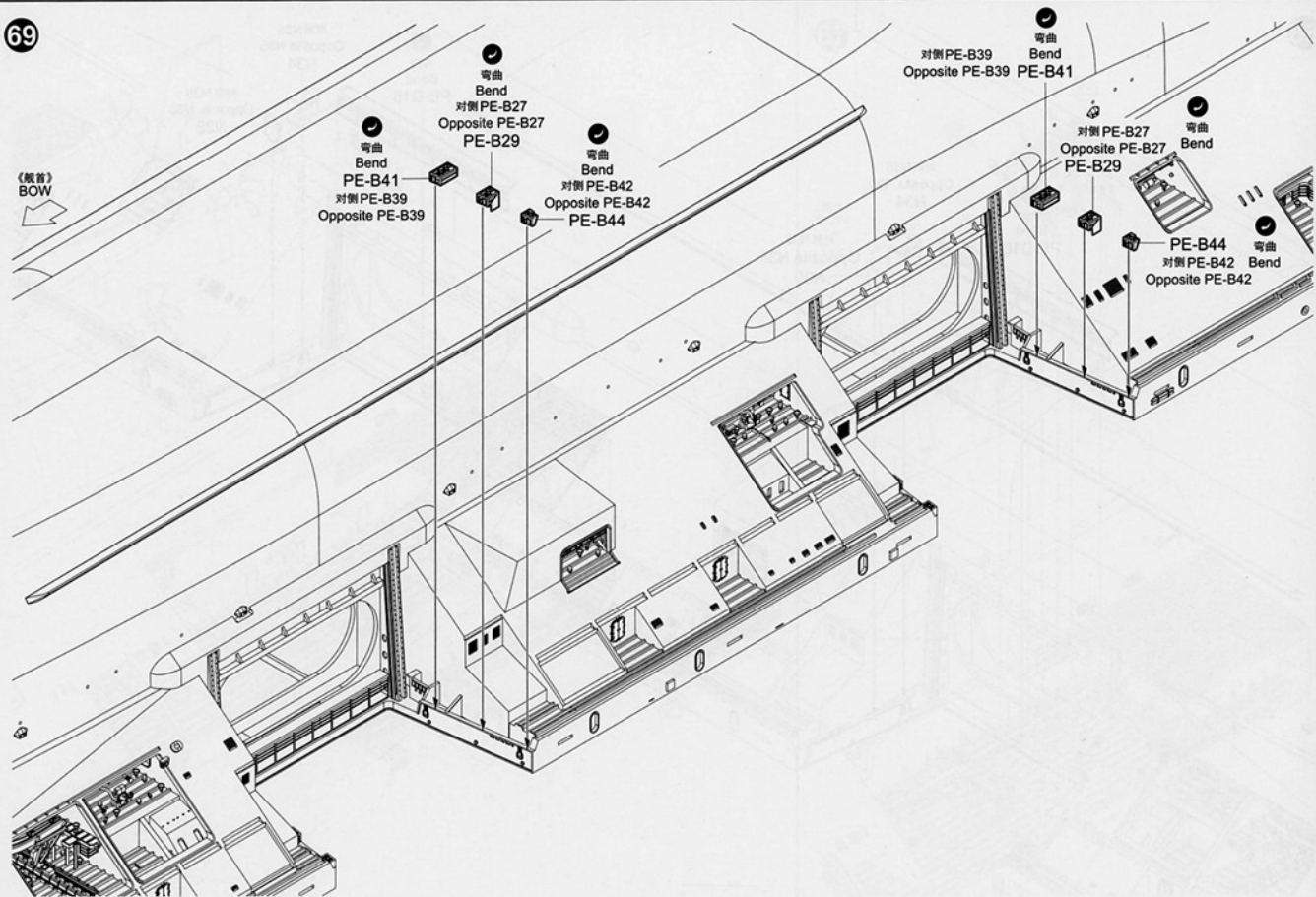
《瓶首》
BOW

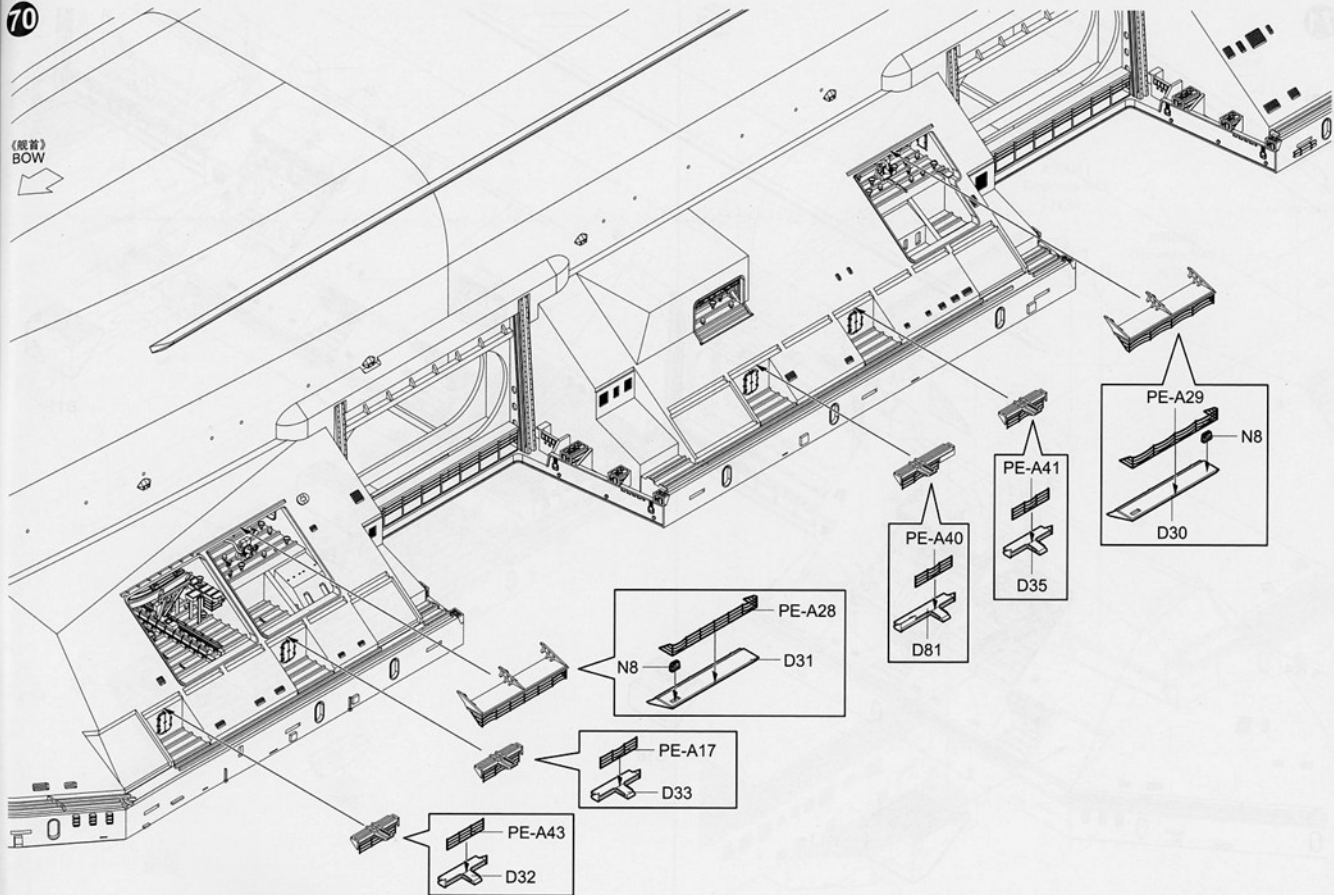
(前方)
BOW

71

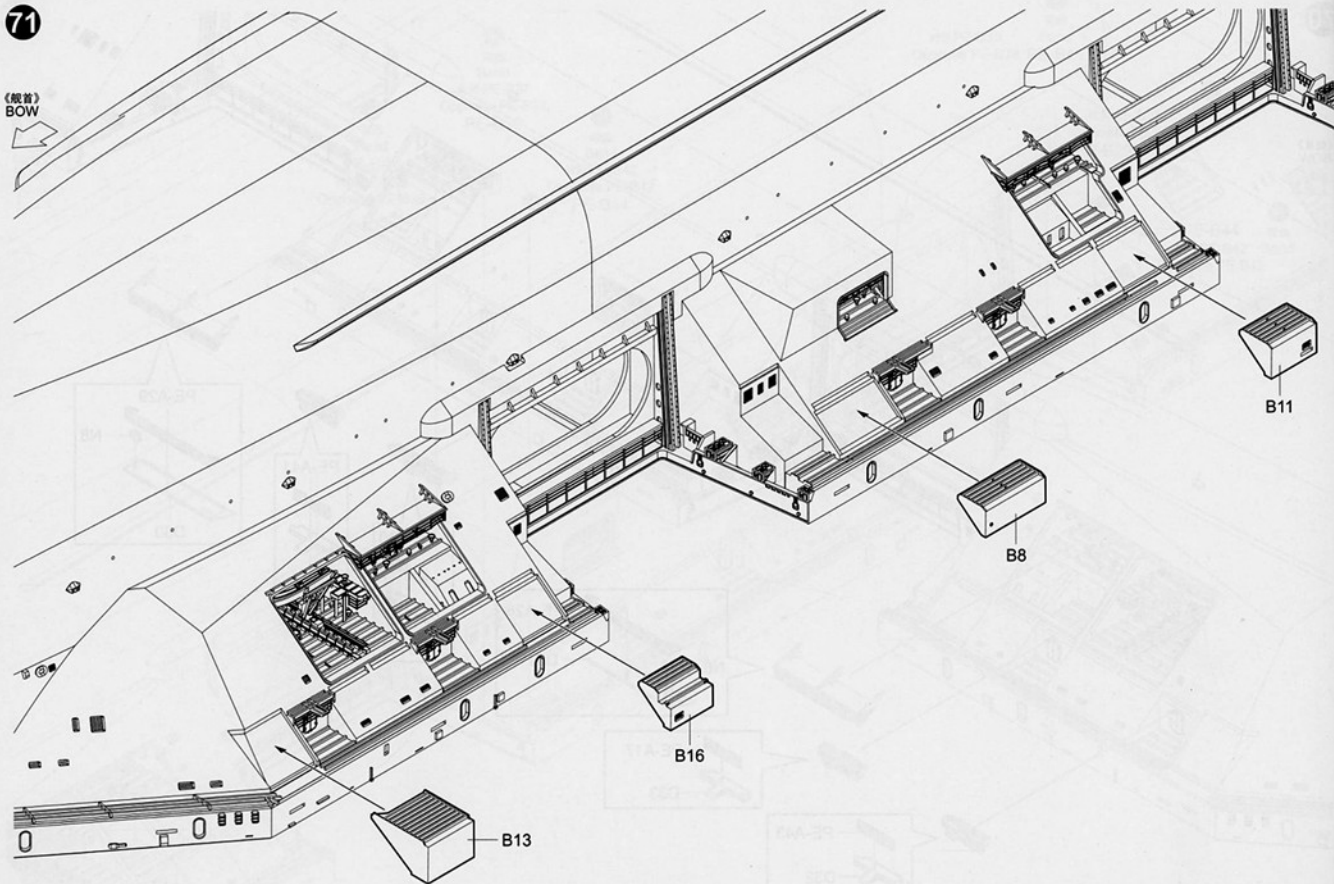
《観音》
BOW

72

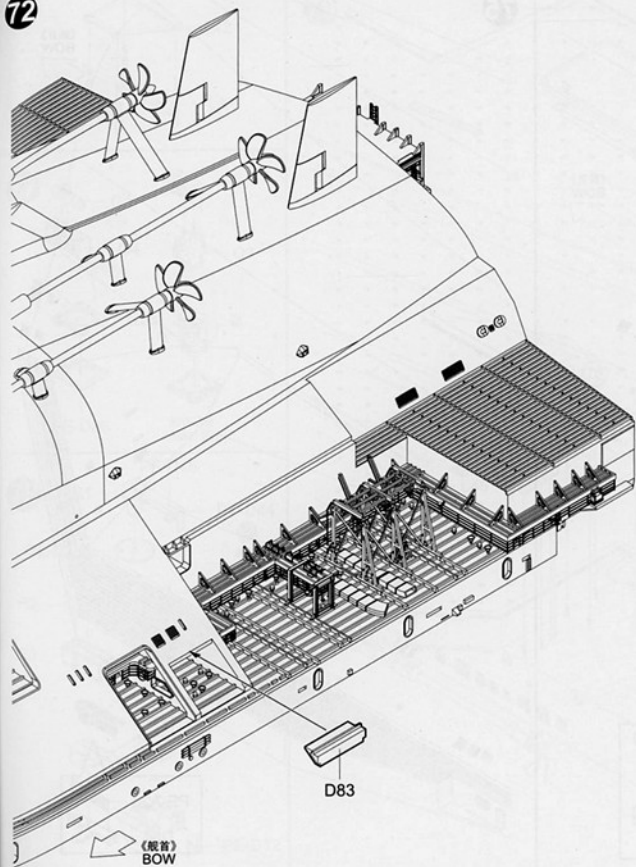

05638

73

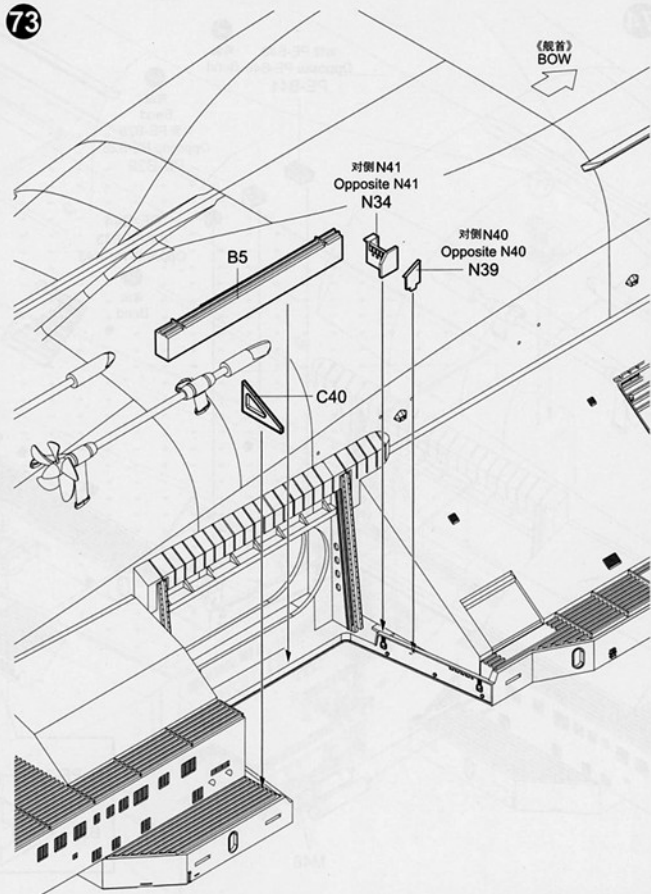

37

74

对侧 PE-B40
Opposite PE-B40 Bend
PE-B41



弯曲

弯曲
Bend
对侧 PE-B28
Opposite PE-B28
PE-B29



弯曲

PE-B44
对侧 PE-B43
Opposite PE-B43



弯曲

《舰首》
BOW

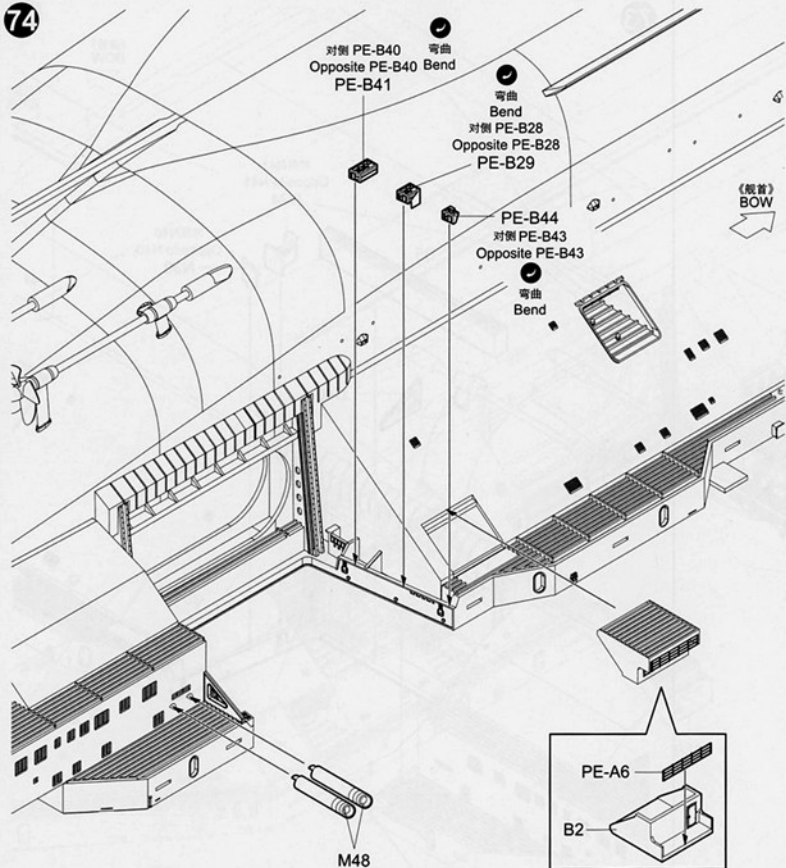

M48

PE-A6

B2

75

《舰首》
BOW

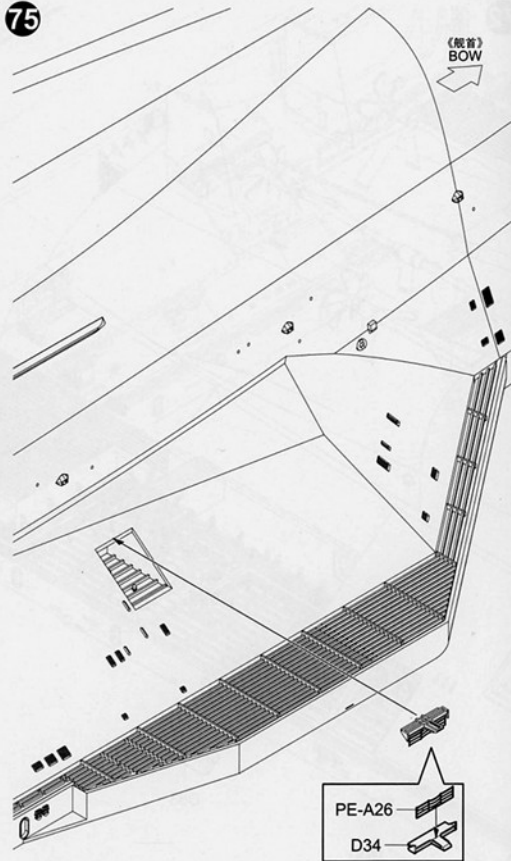

PE-A26

D34

76

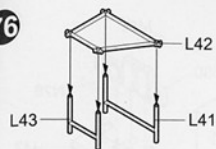

77

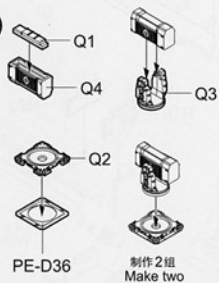

78

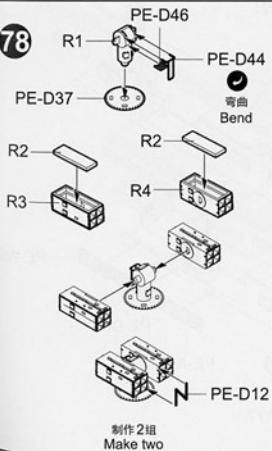

79

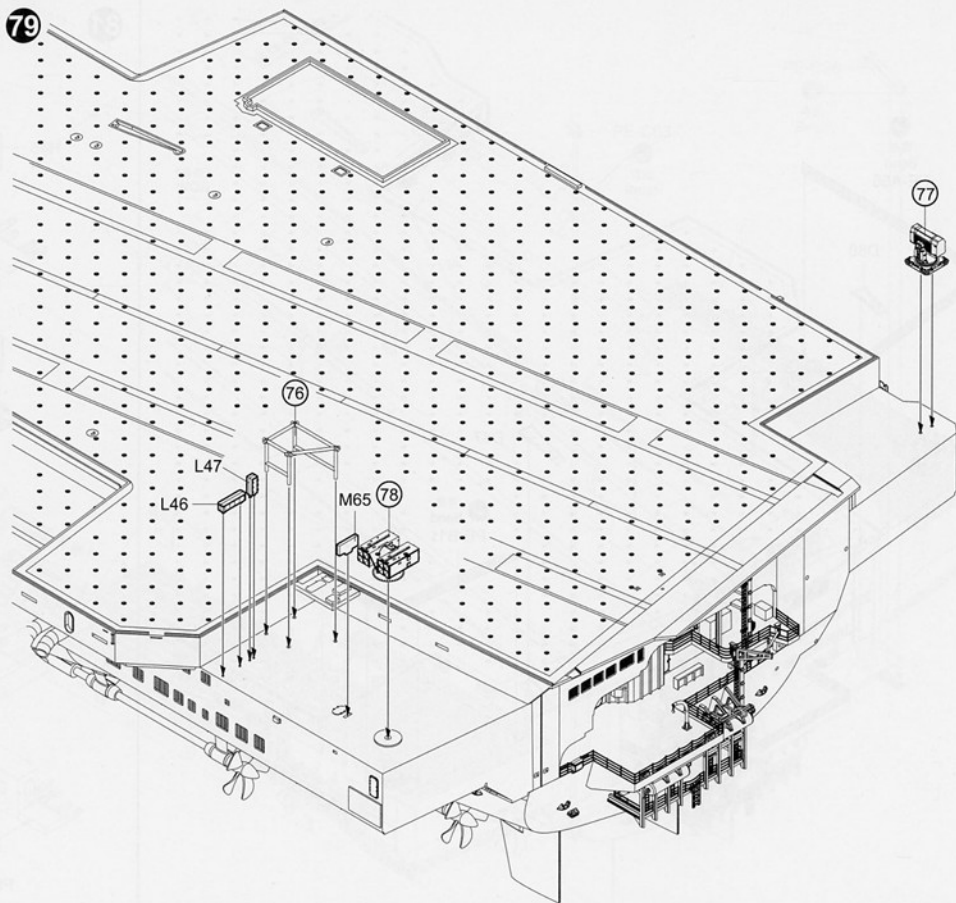

80

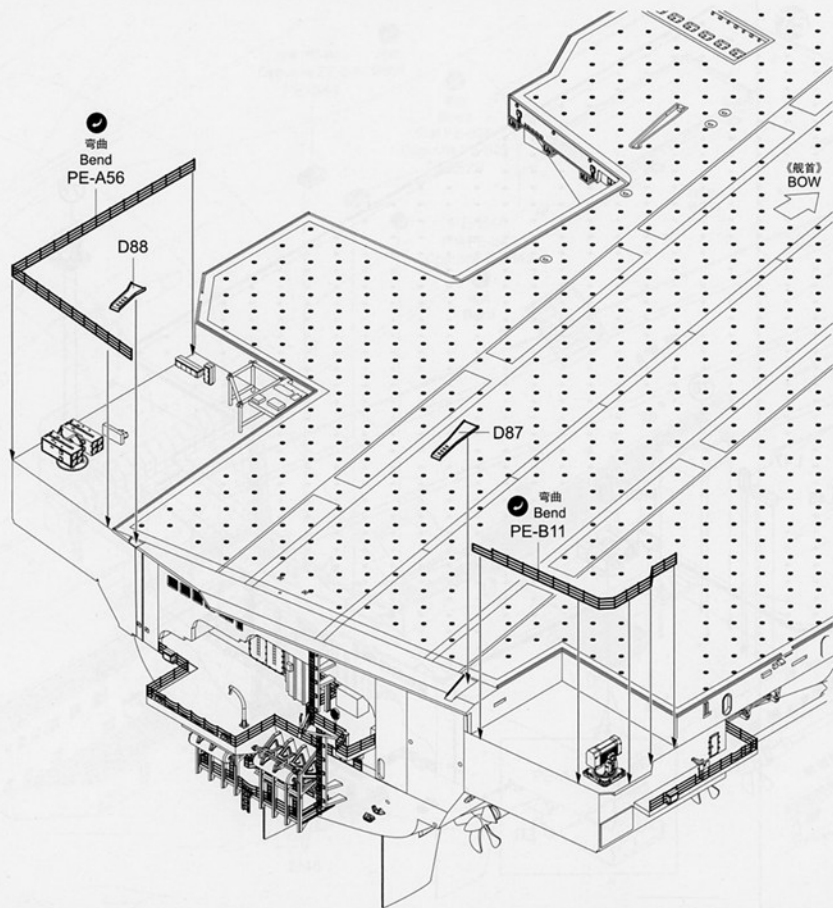

81

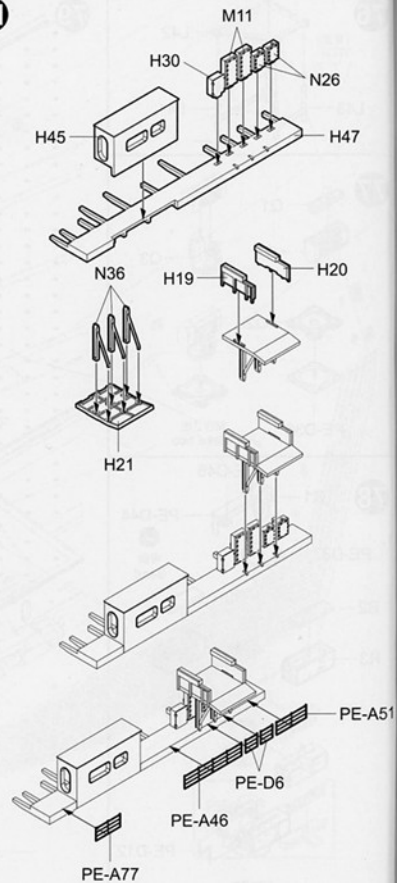

32

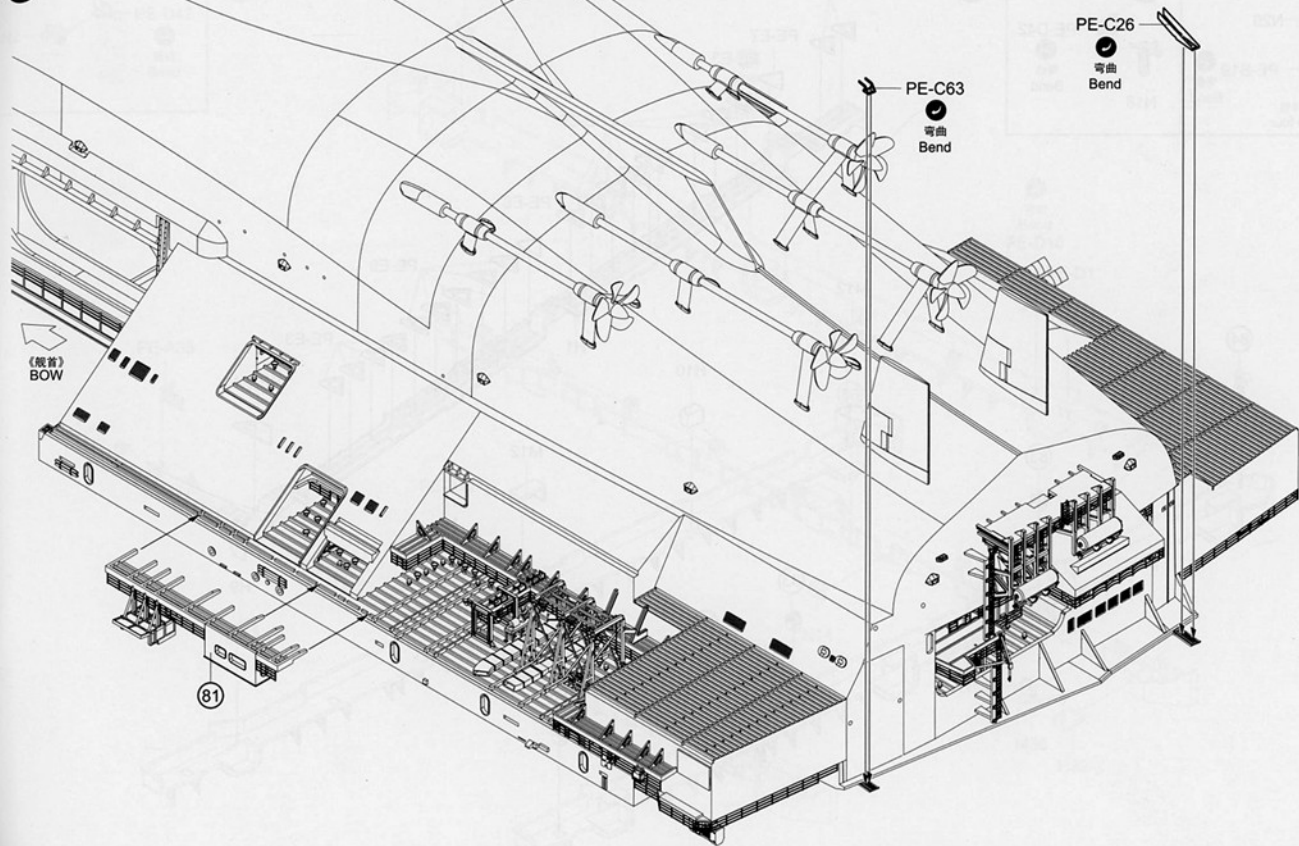

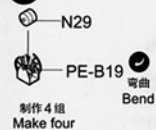
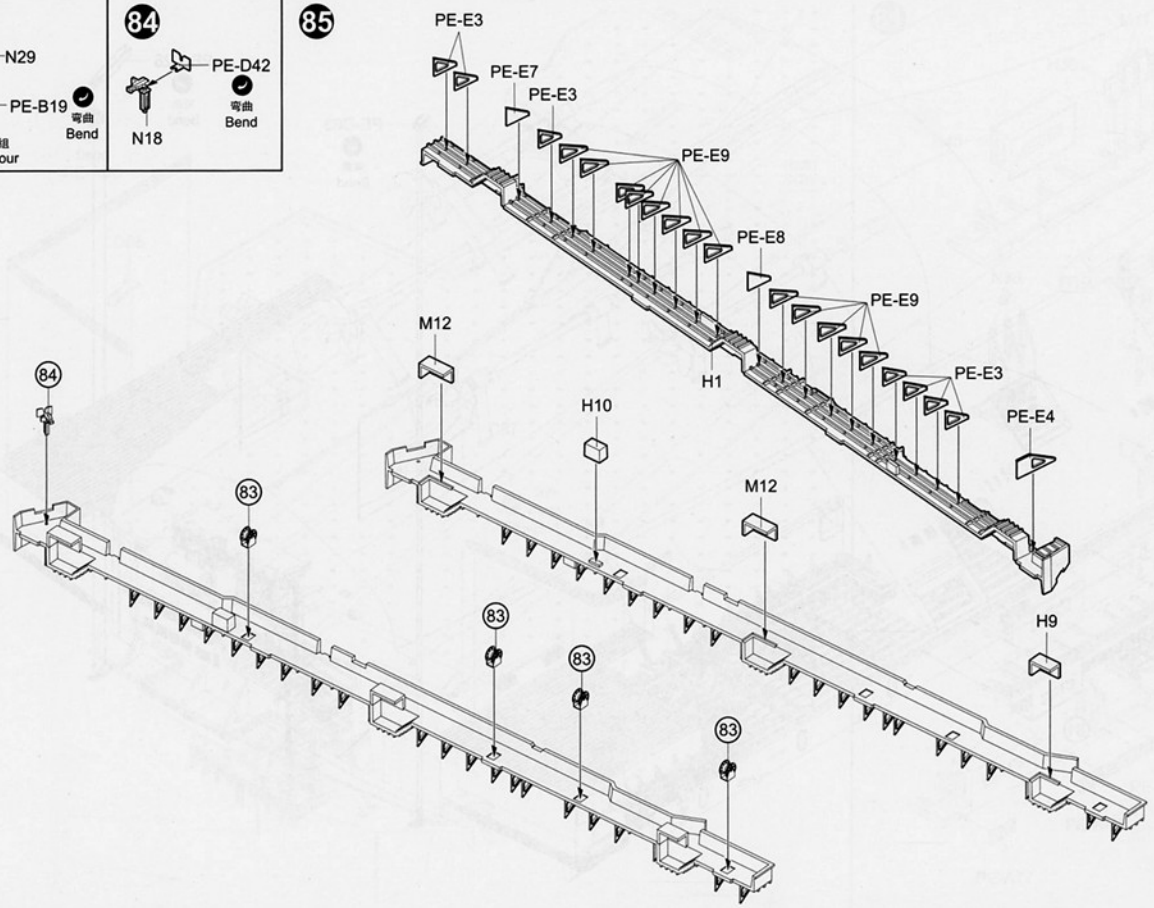
83**84****85**

86



87

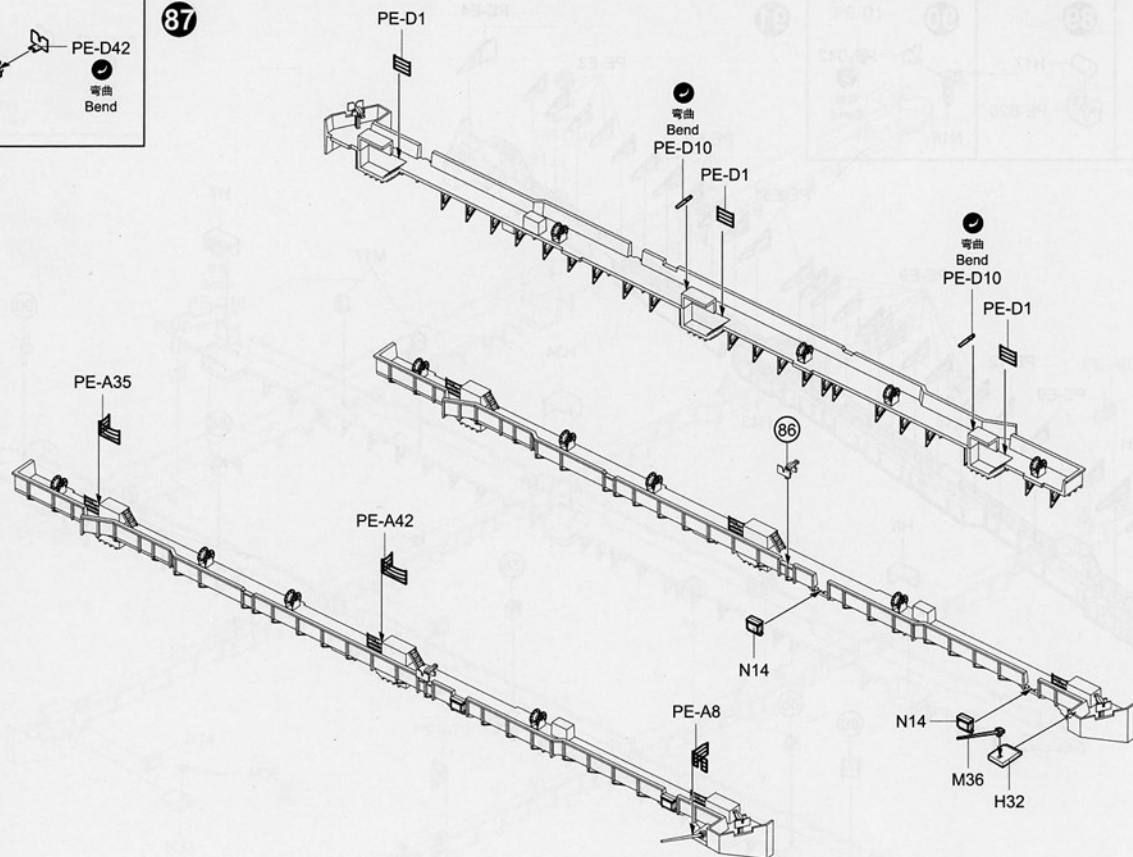

88

N29

PE-B19

制作3组
Make three弯曲
Bend

89

H17

PE-B20

90

PE-D42

N18

弯曲
Bend

91

PE-E4

PE-E3

PE-E9

PE-E31

PE-E9

PE-12

PE-E9

PE-E31

H43

H34

M17

H7

90

88

88

88

89

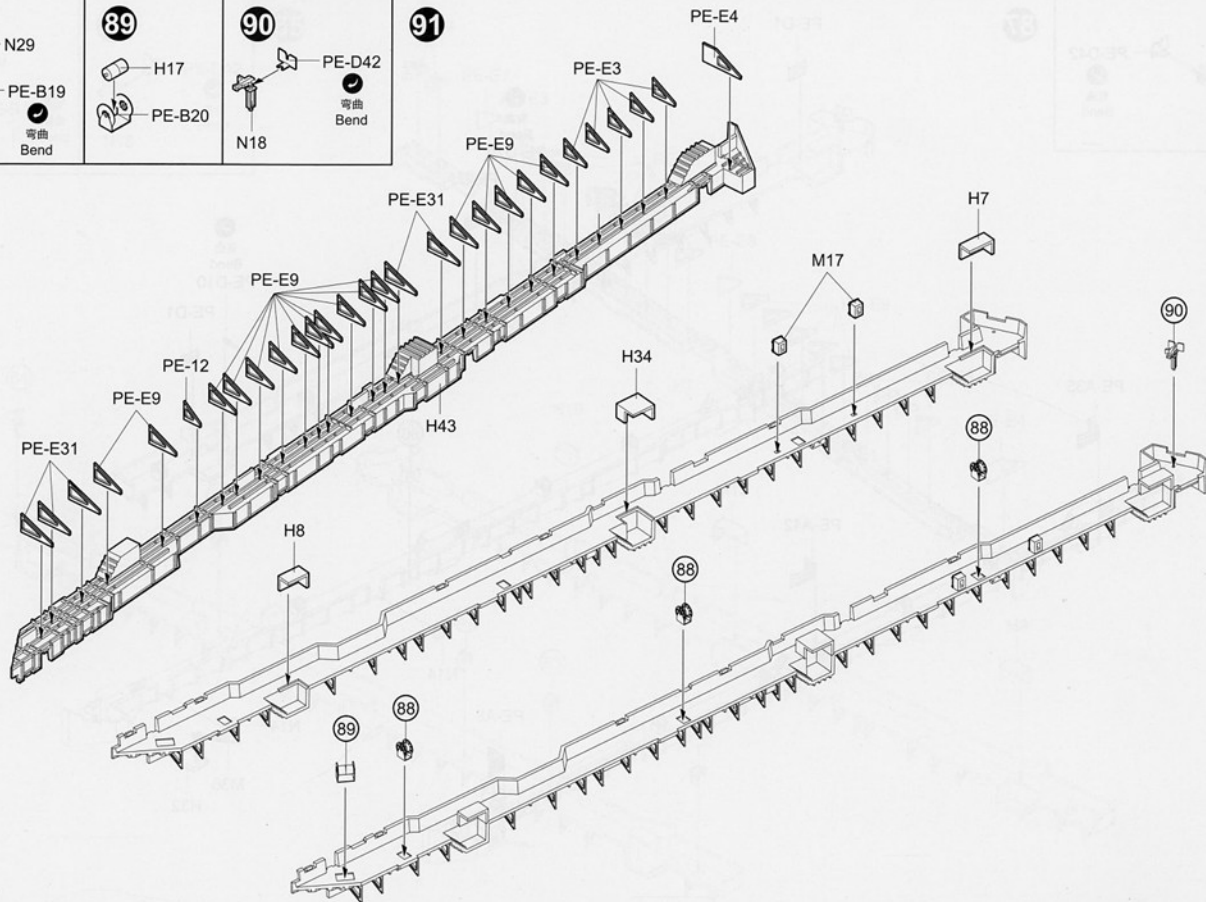

92

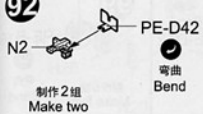

93

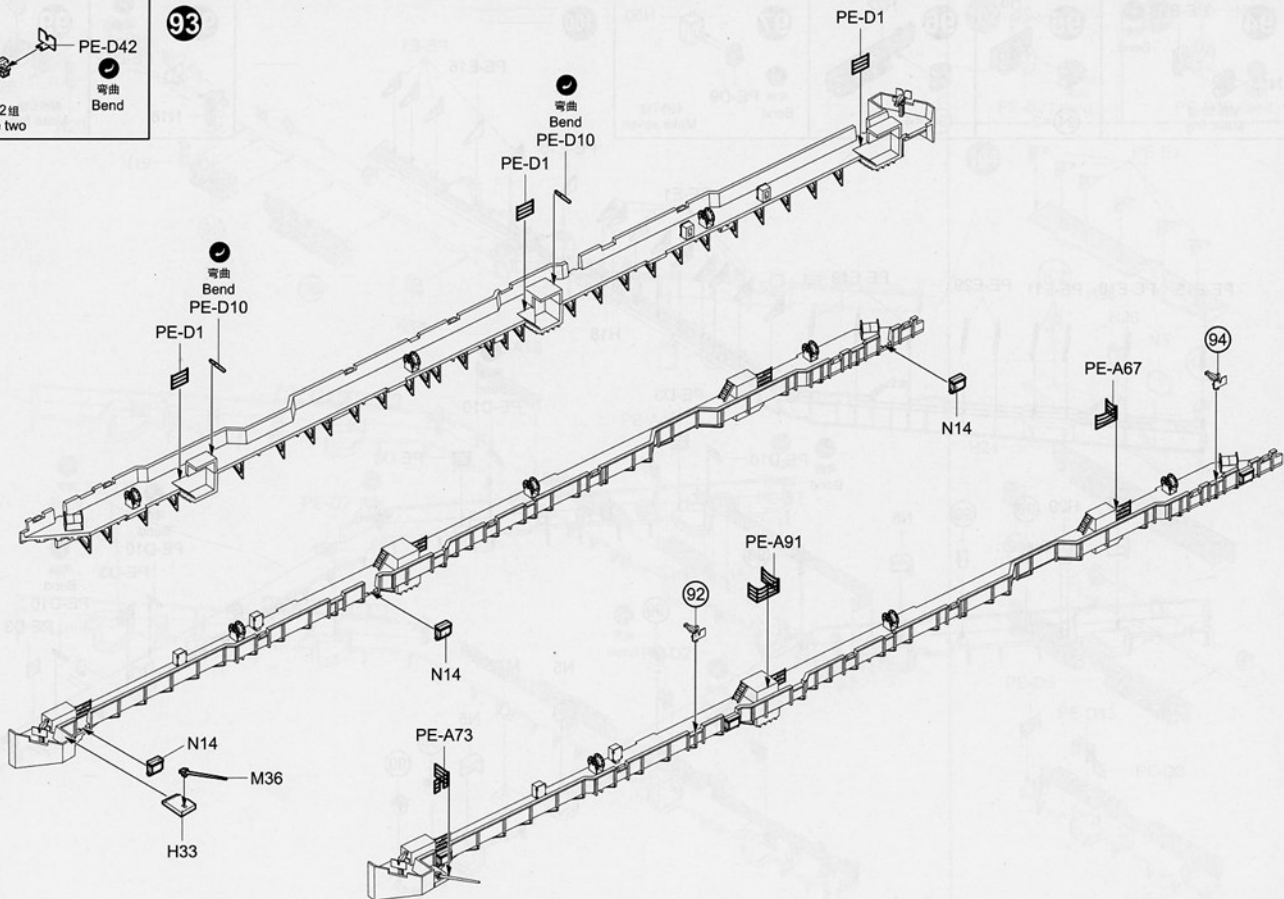

101

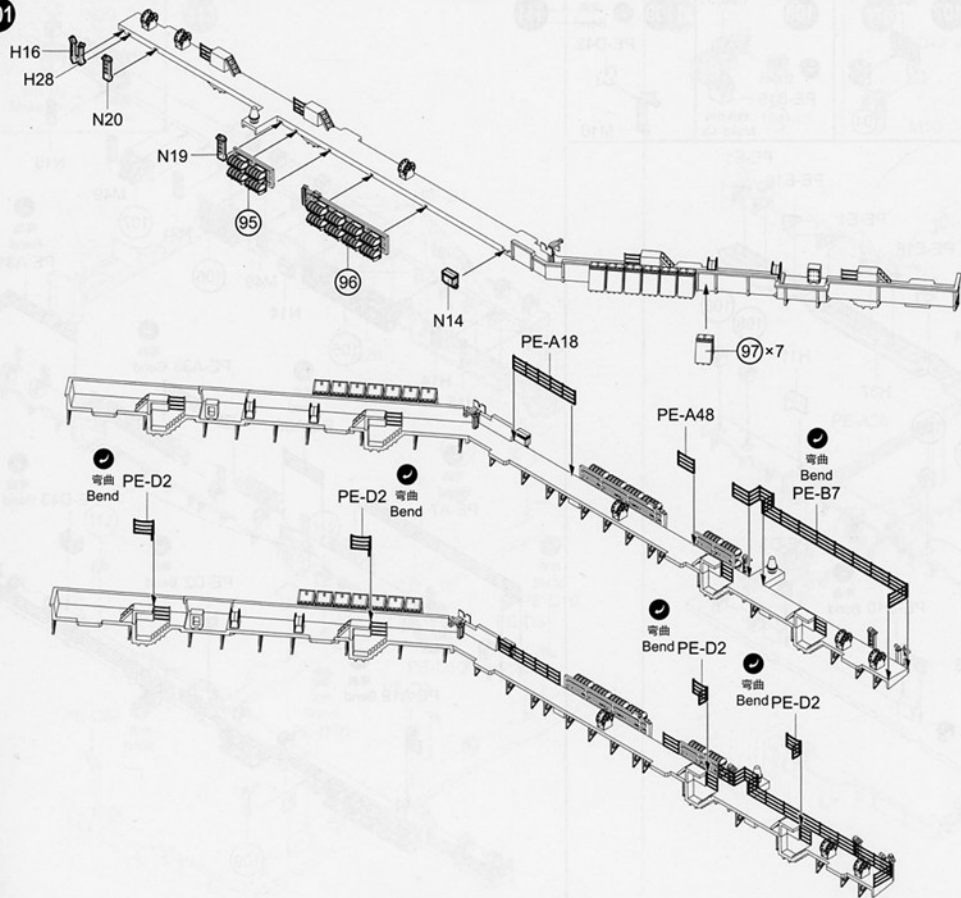

102

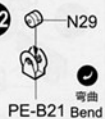

103



104

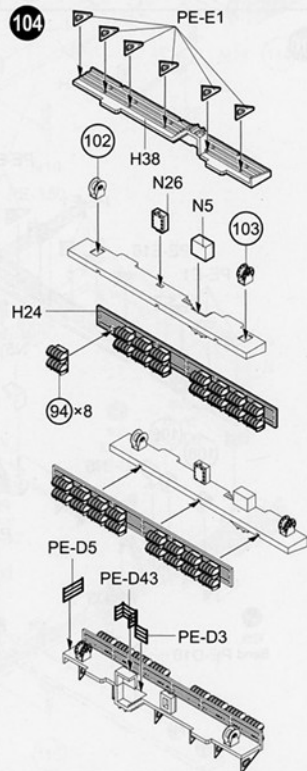

117

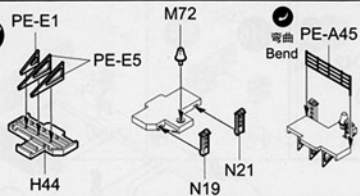

118

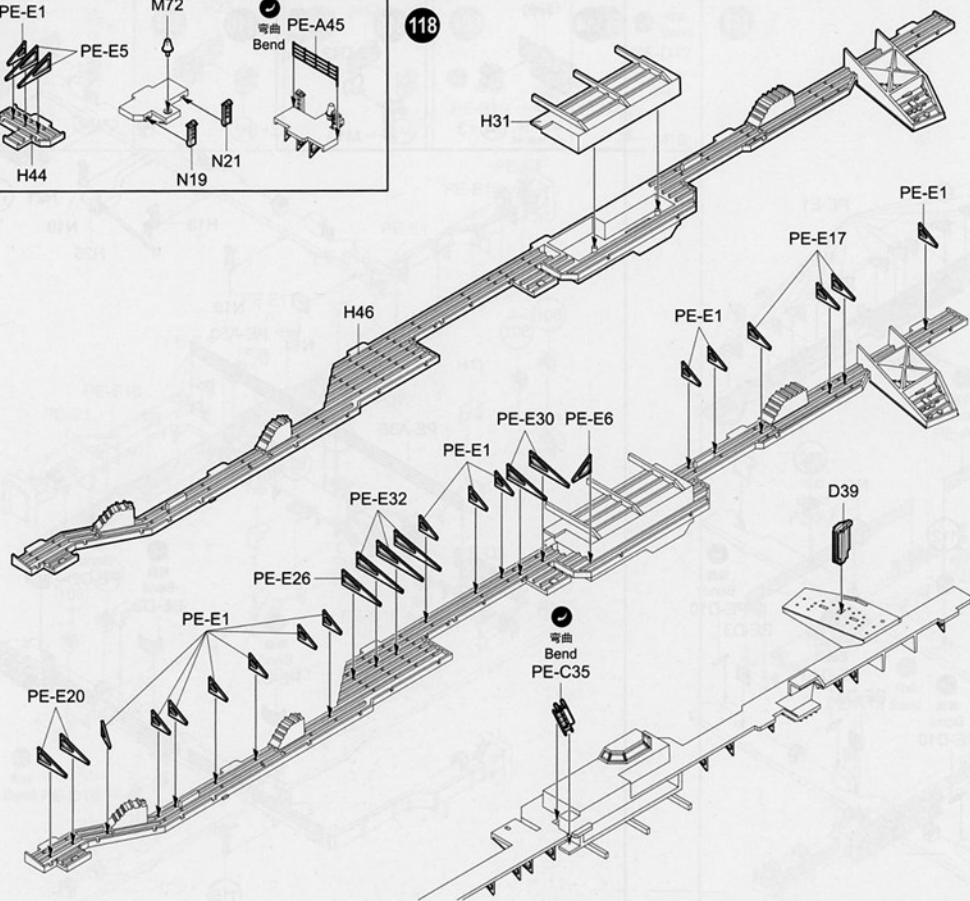

119

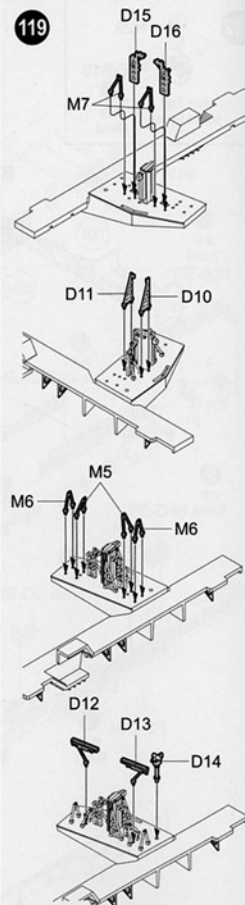

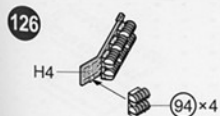
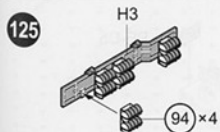
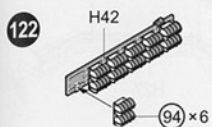

127

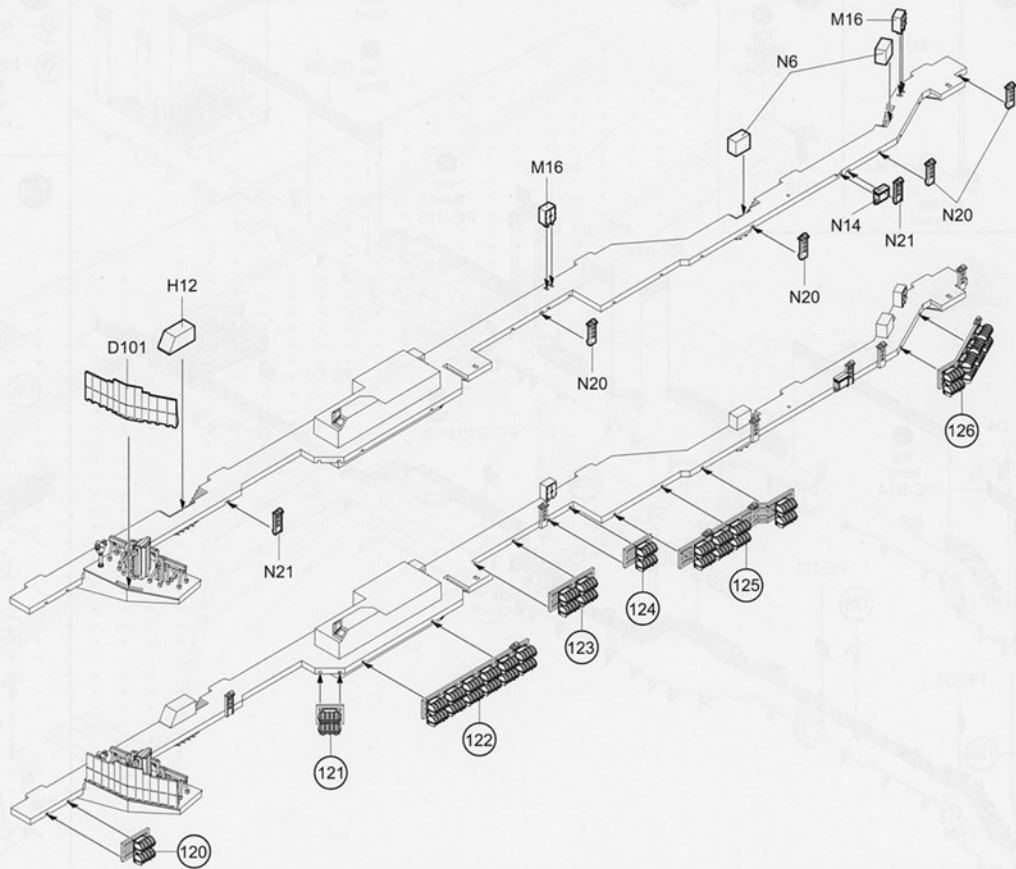

128

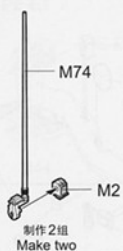

129

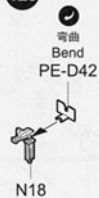

130

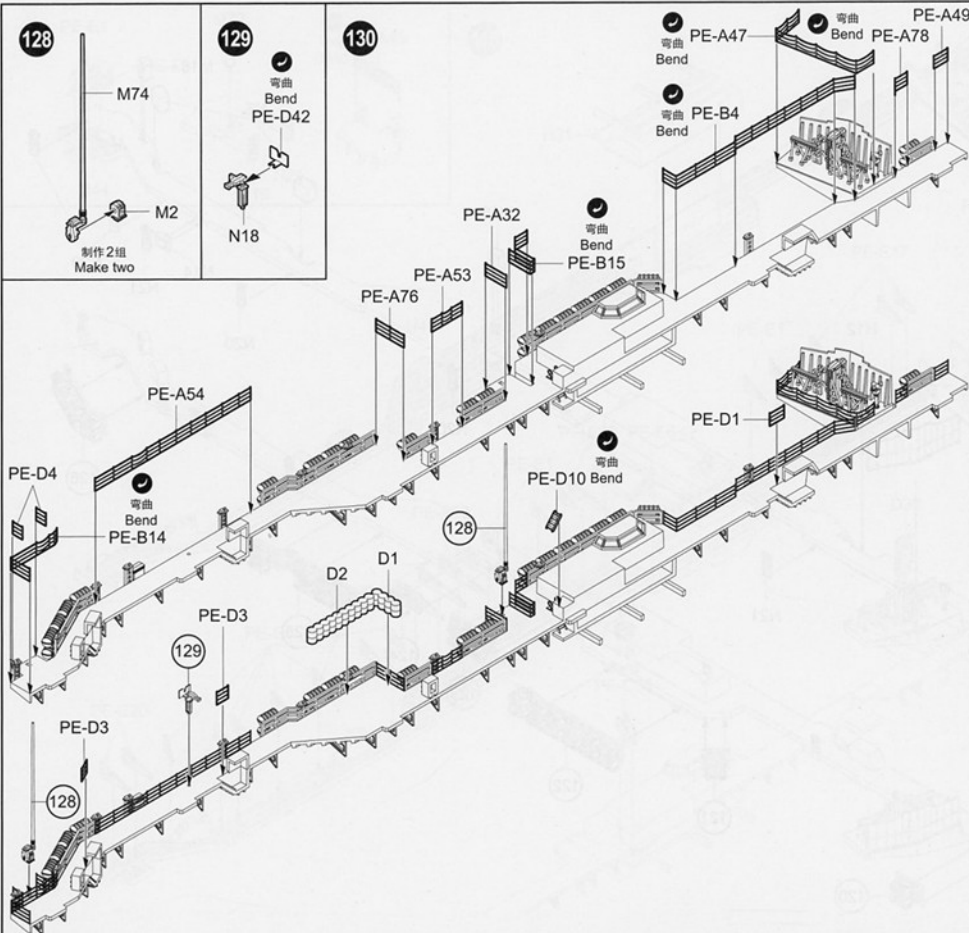

131

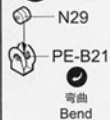

132

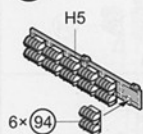

133

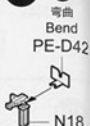

134

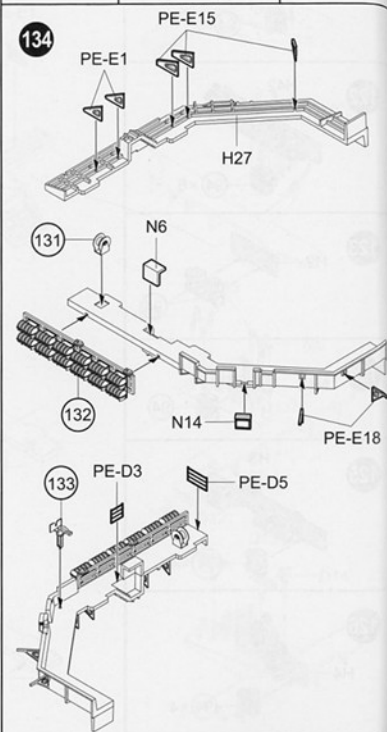

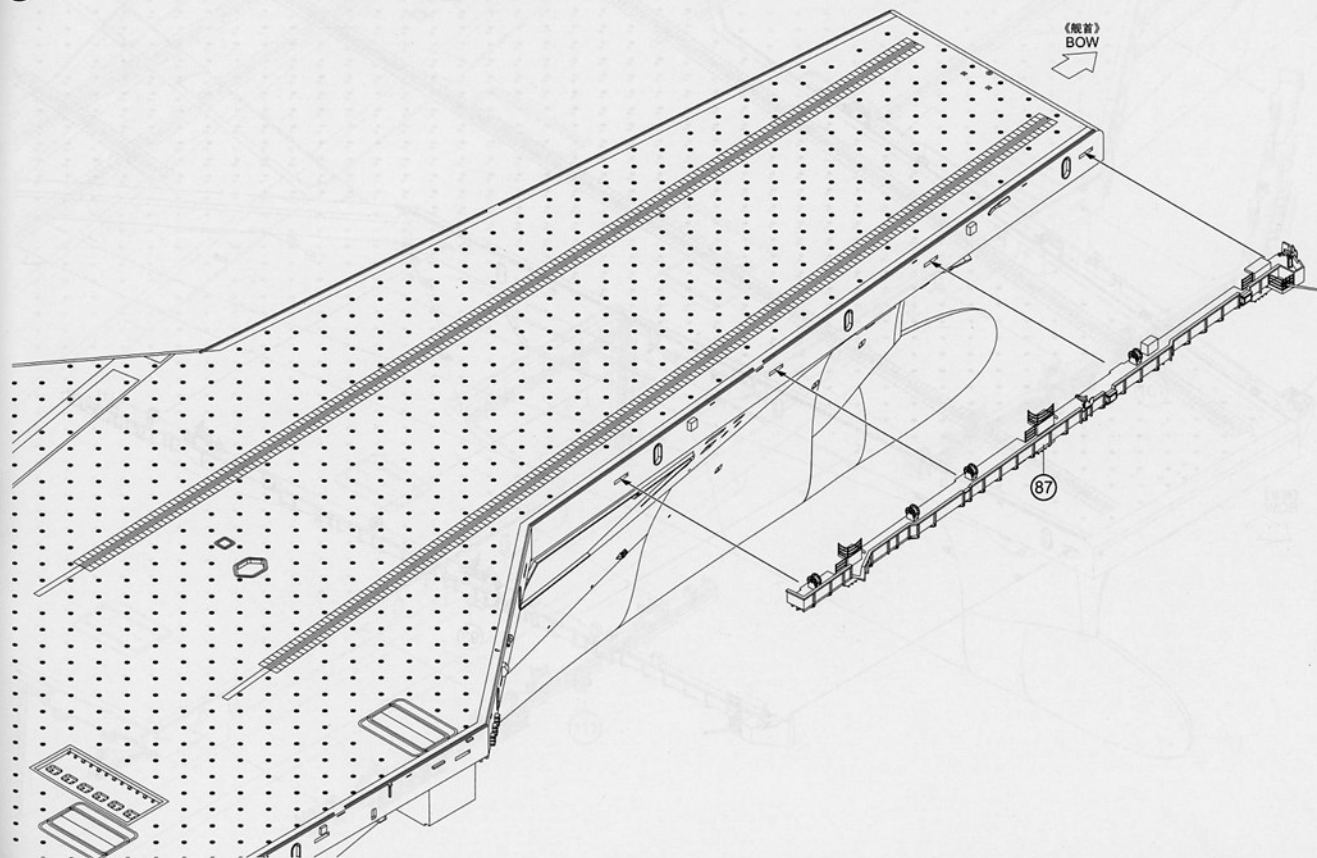

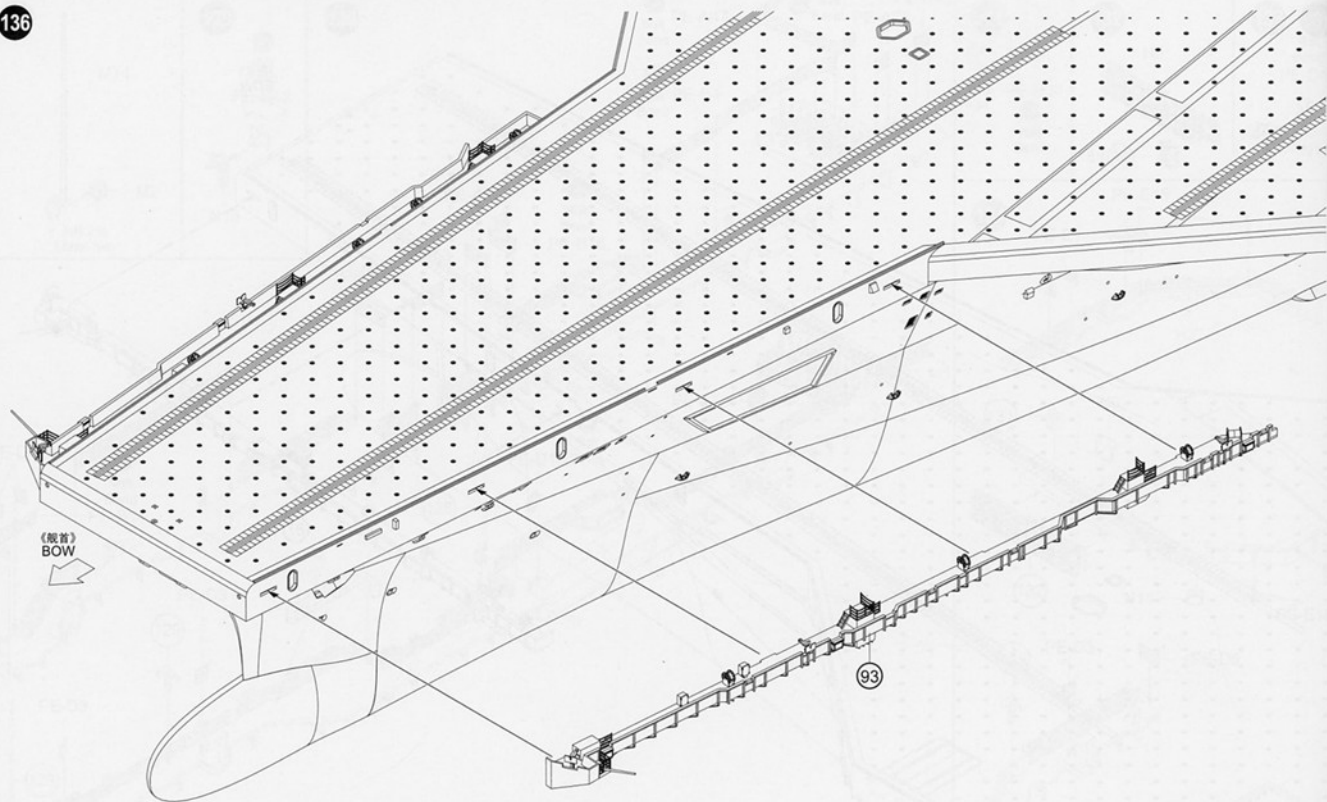

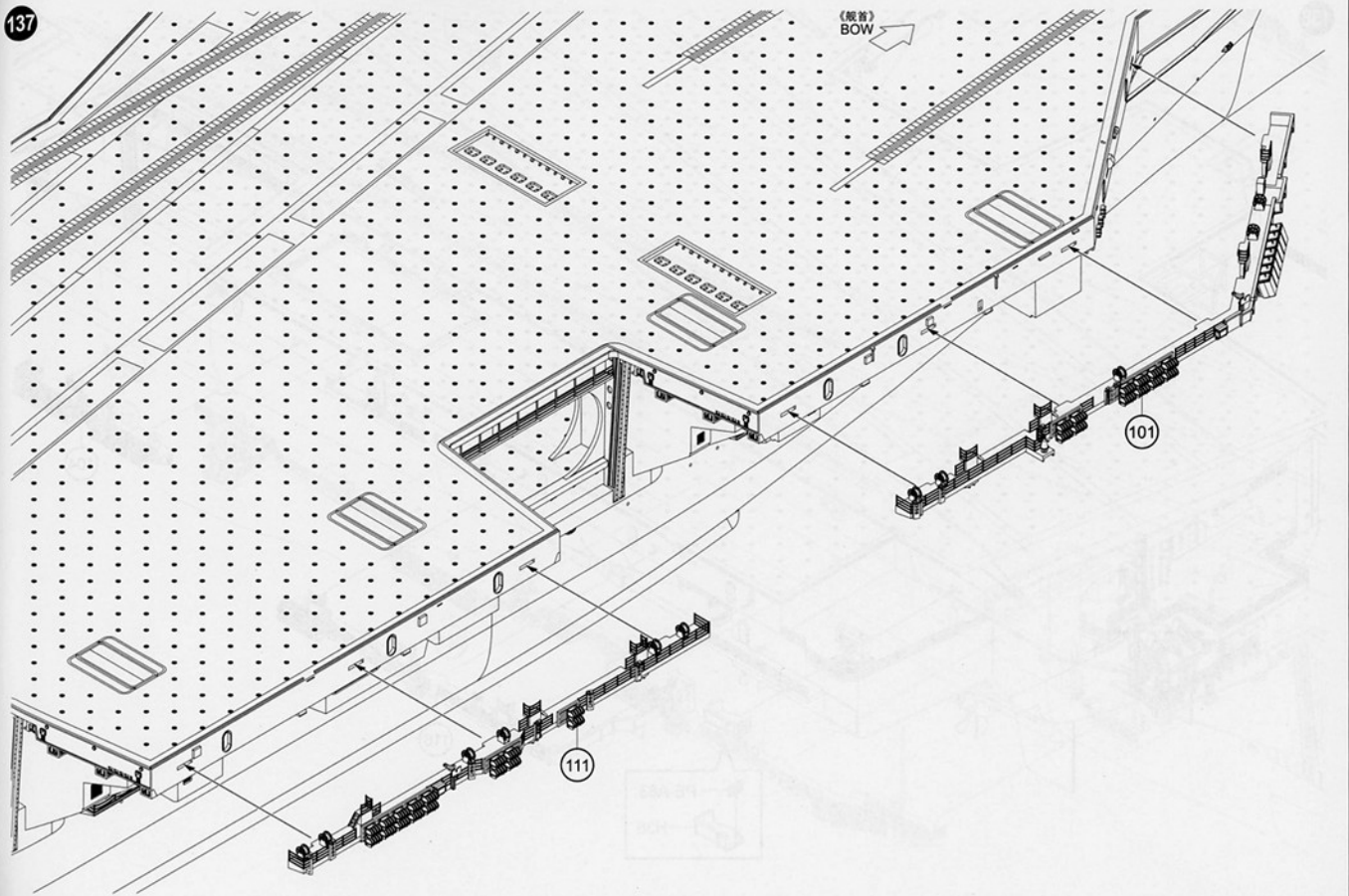

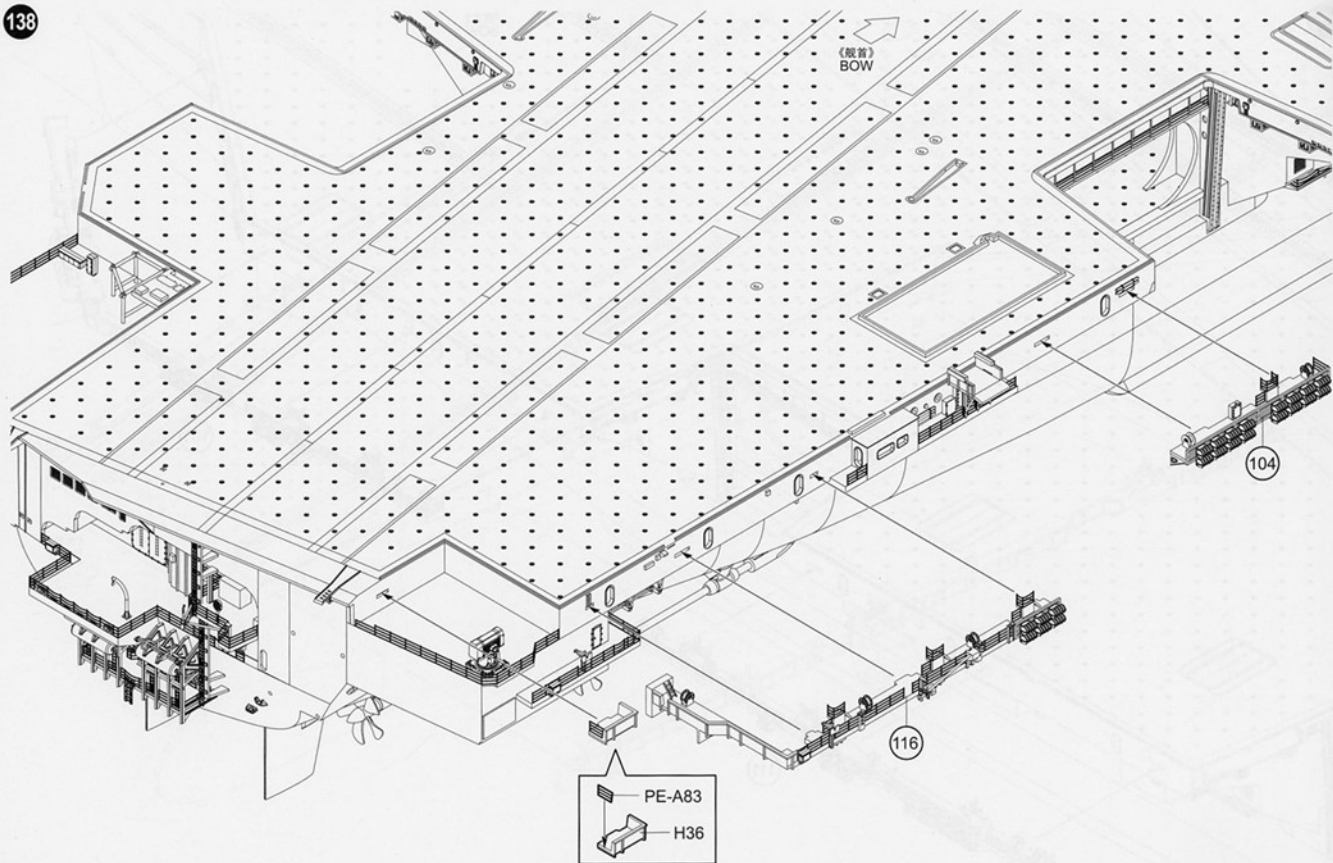

139

《船首》
BOW



117



130

140

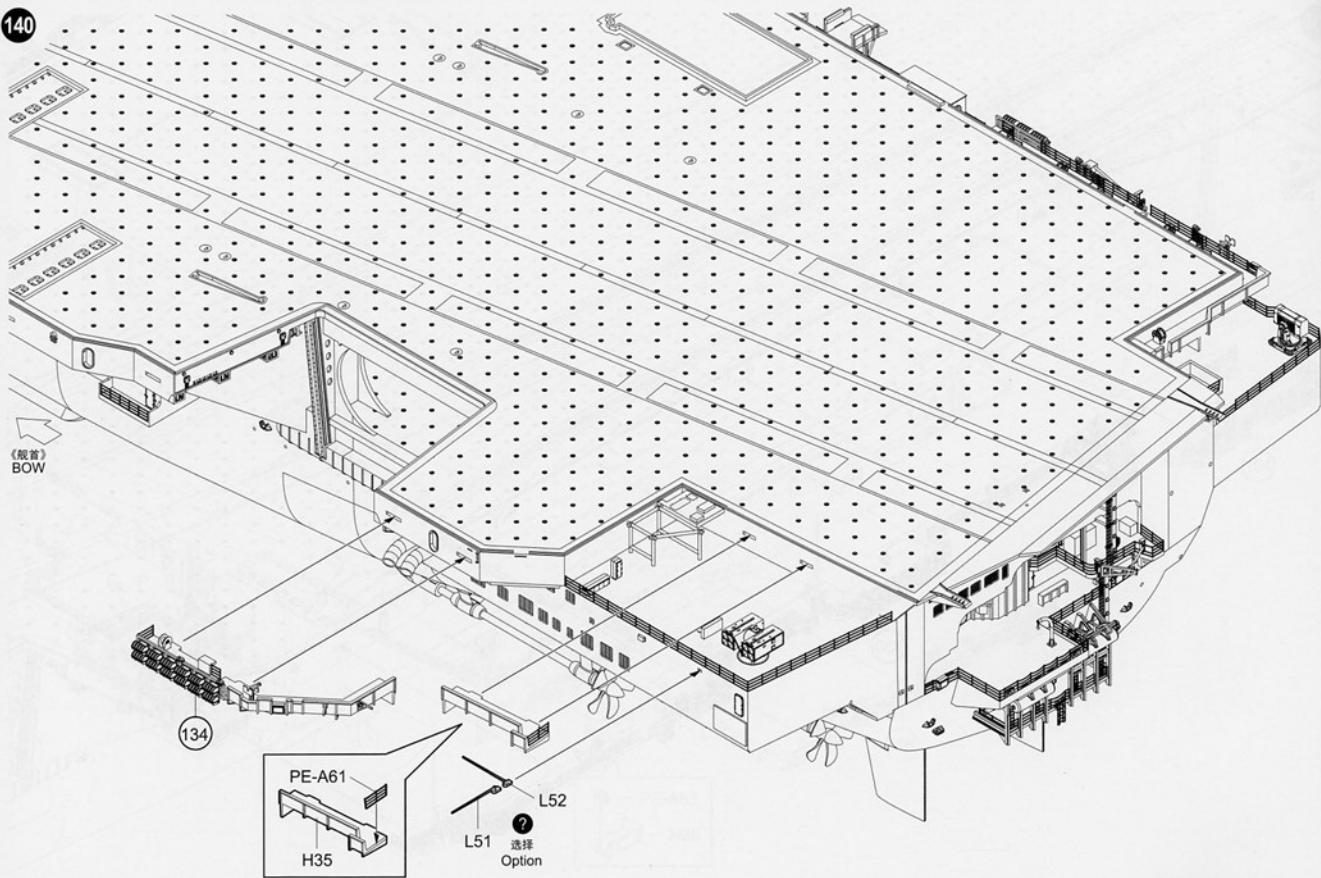

141

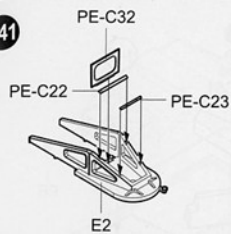

142

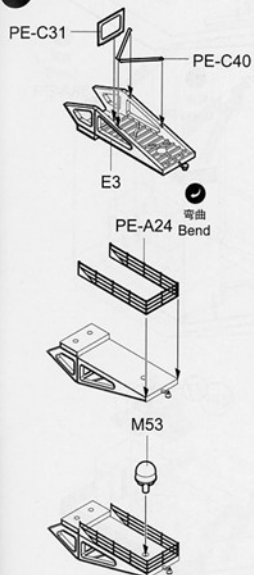

143

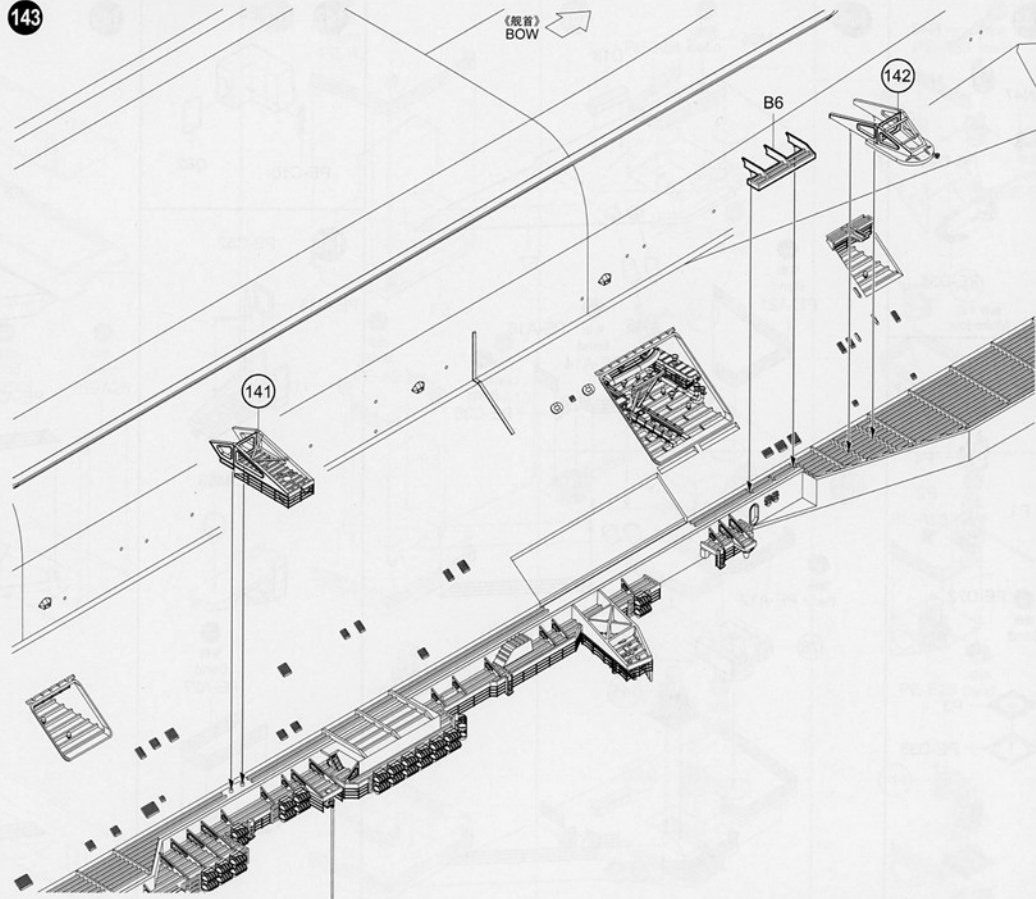

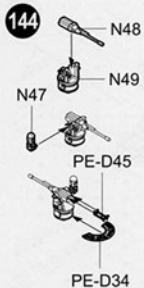

制作4组
Make four

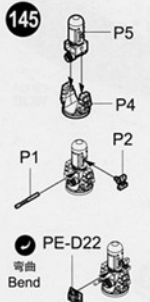

弯曲
Bend

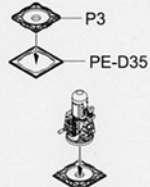

制作3组
Make three

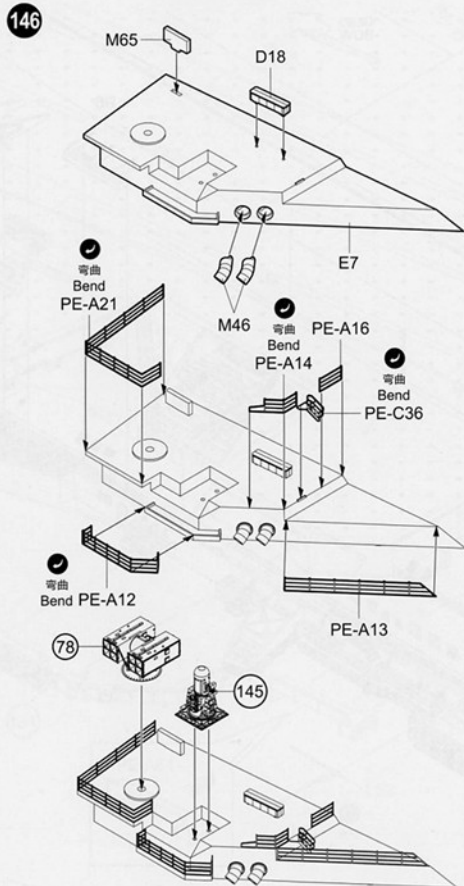

弯曲
Bend

78

145

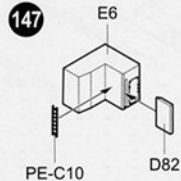

弯曲
Bend
PE-A27

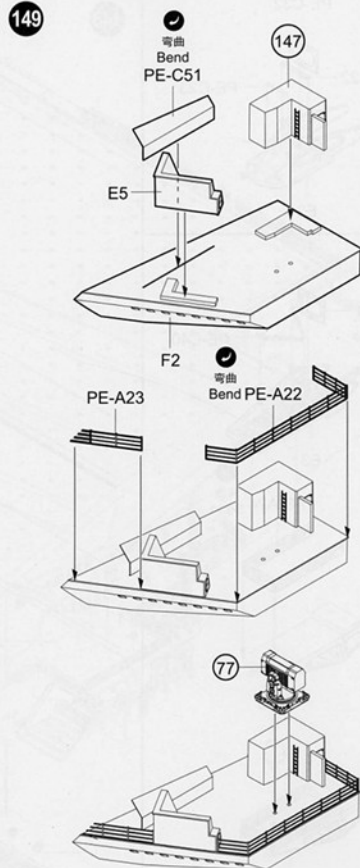
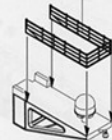

77

150

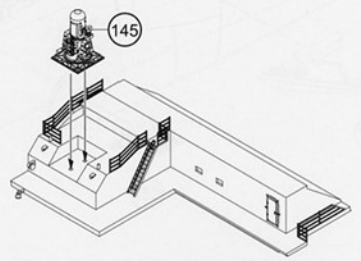
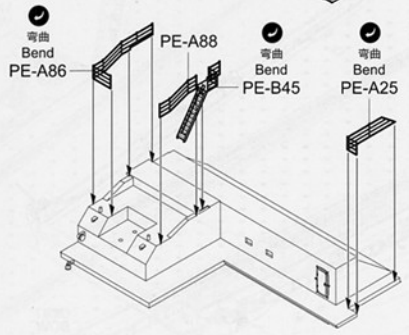
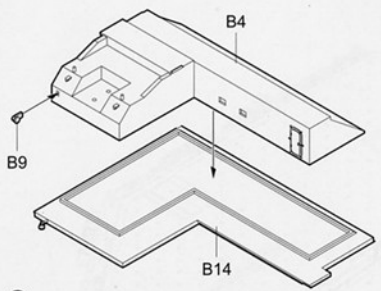

151

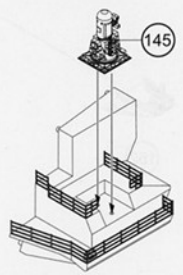
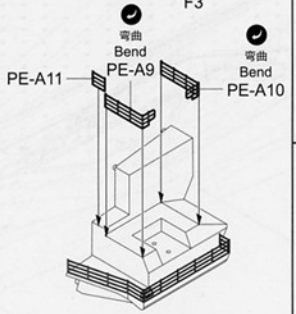
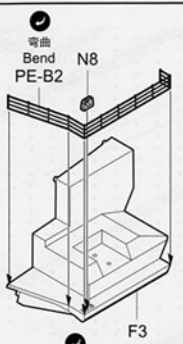

152

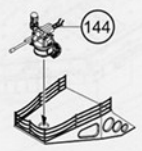

154

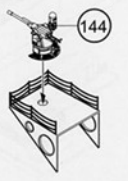
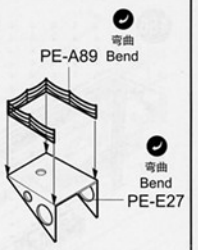

153



155

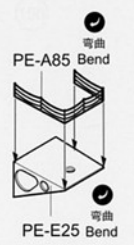

156

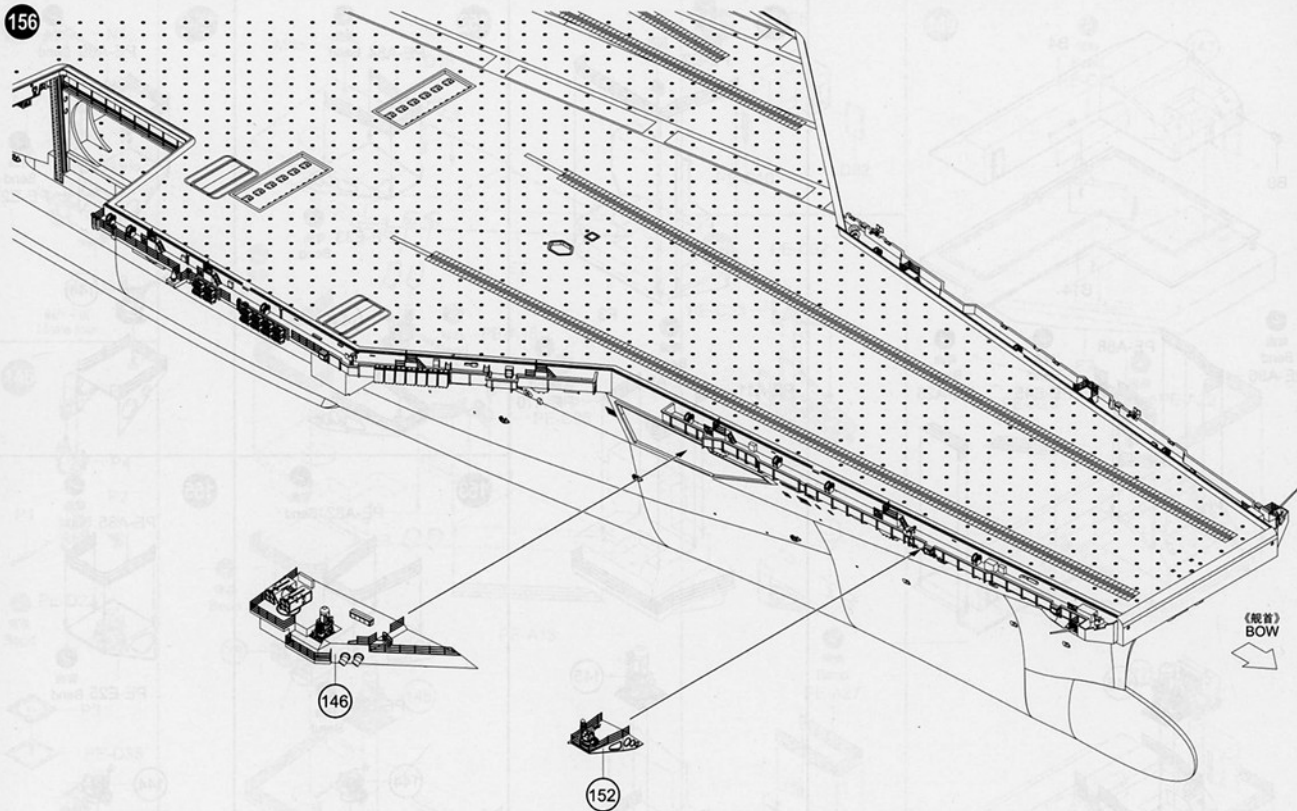

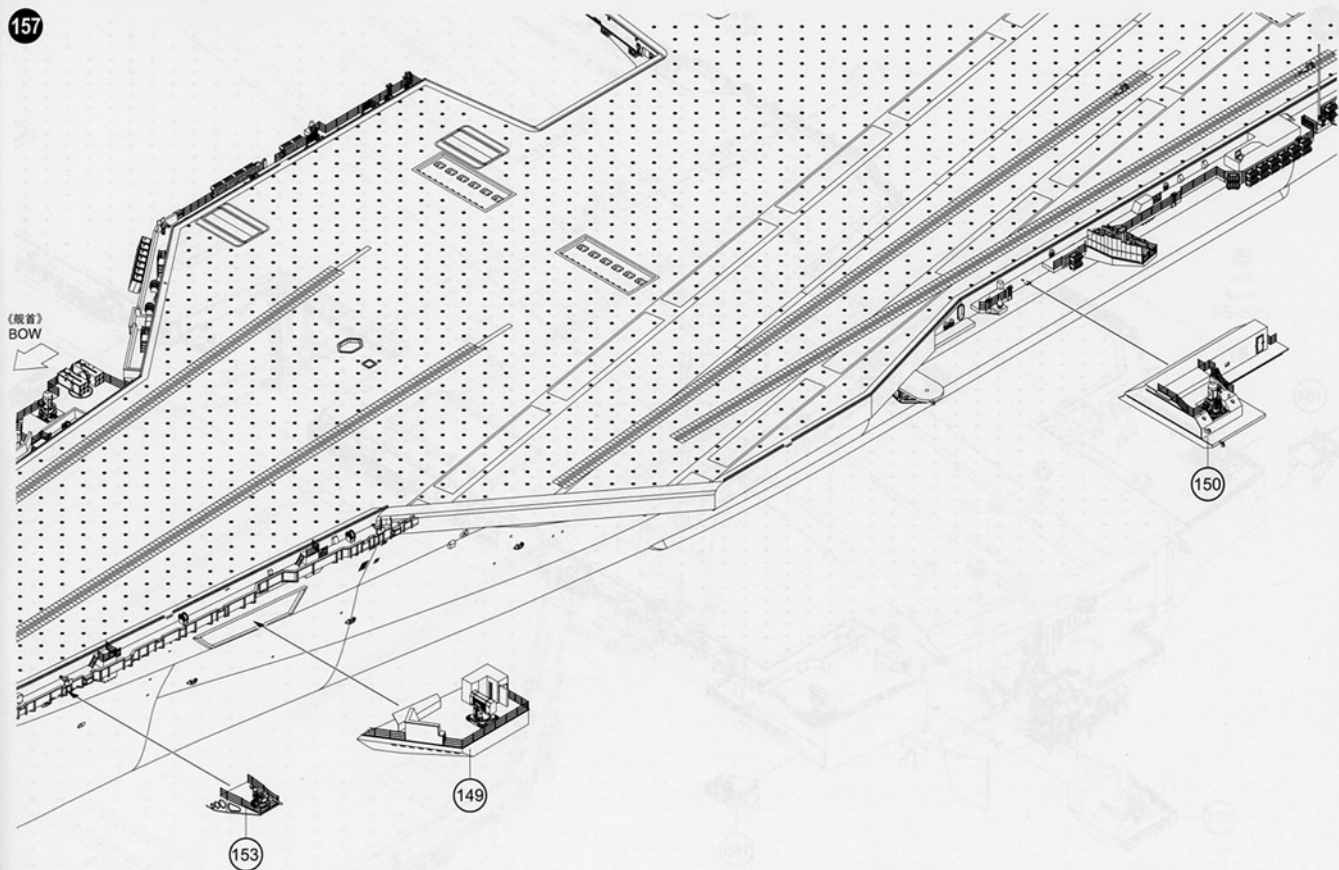

158

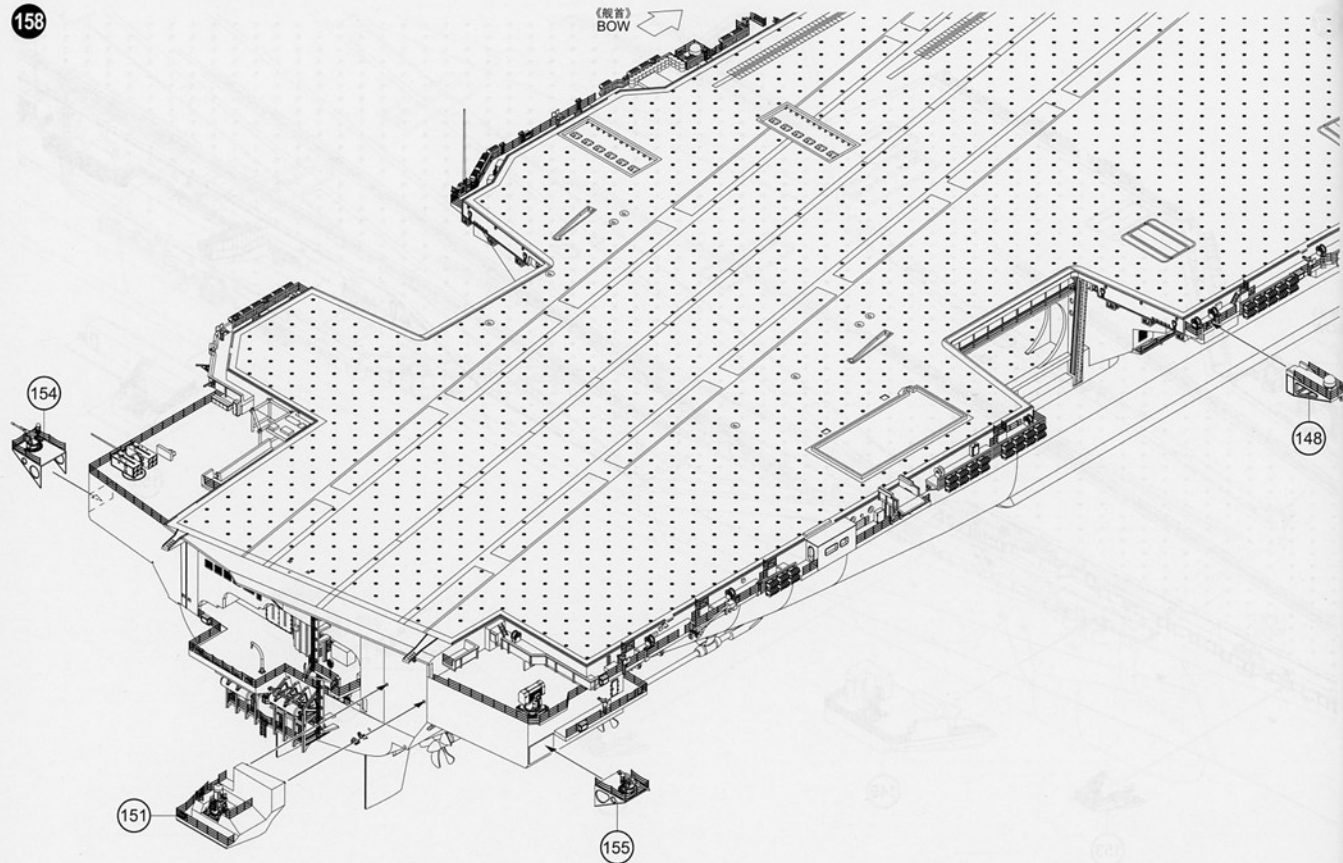
《船首》
BOW

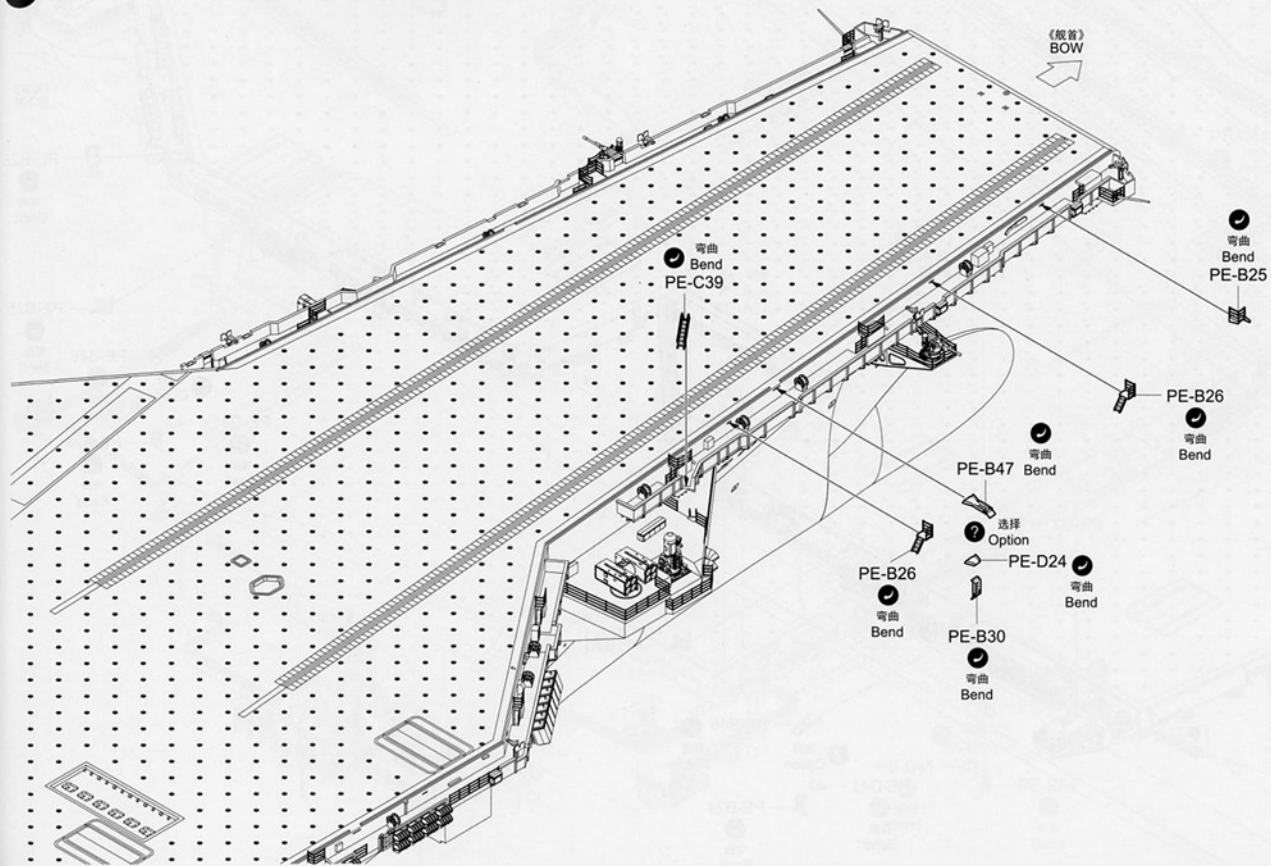

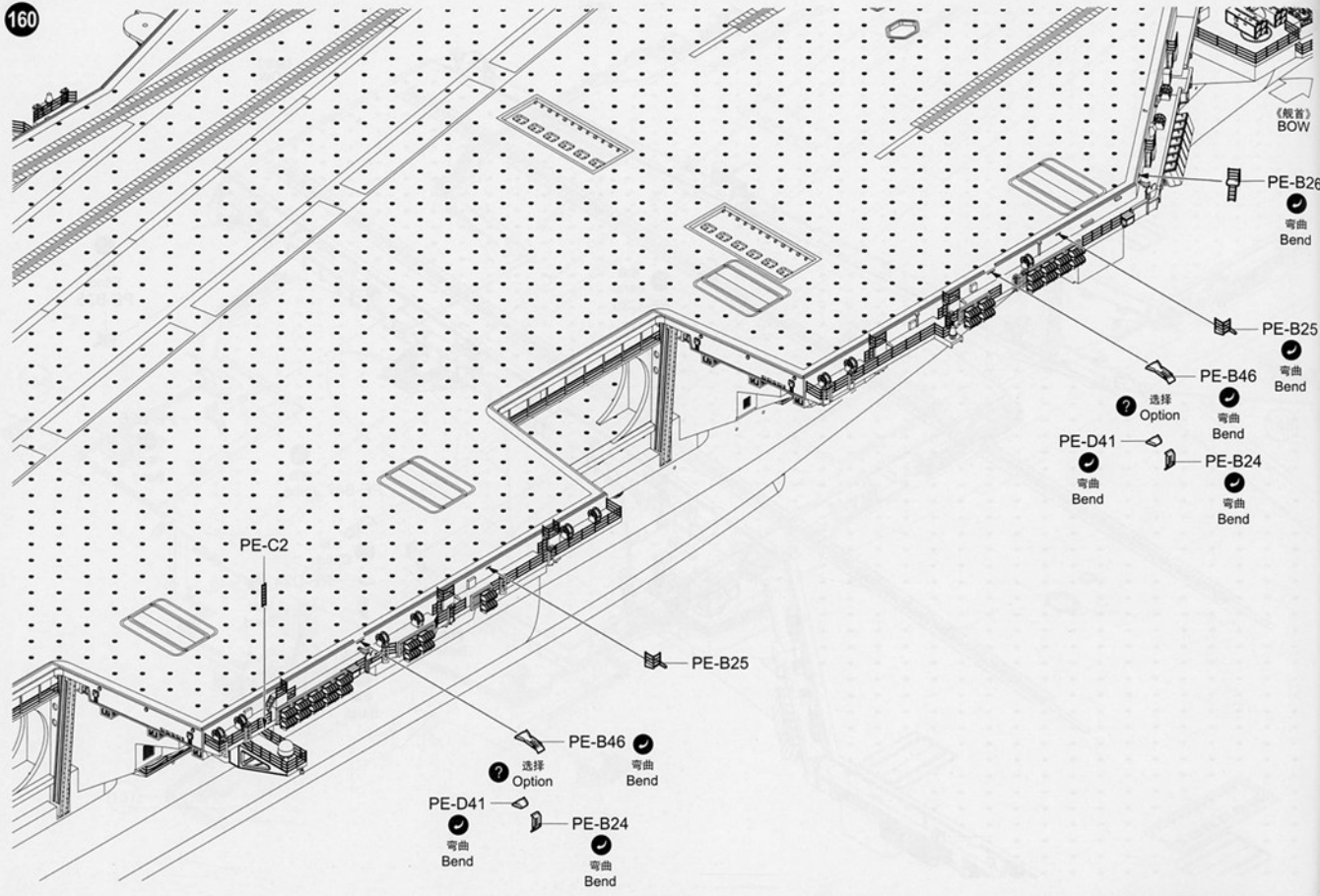

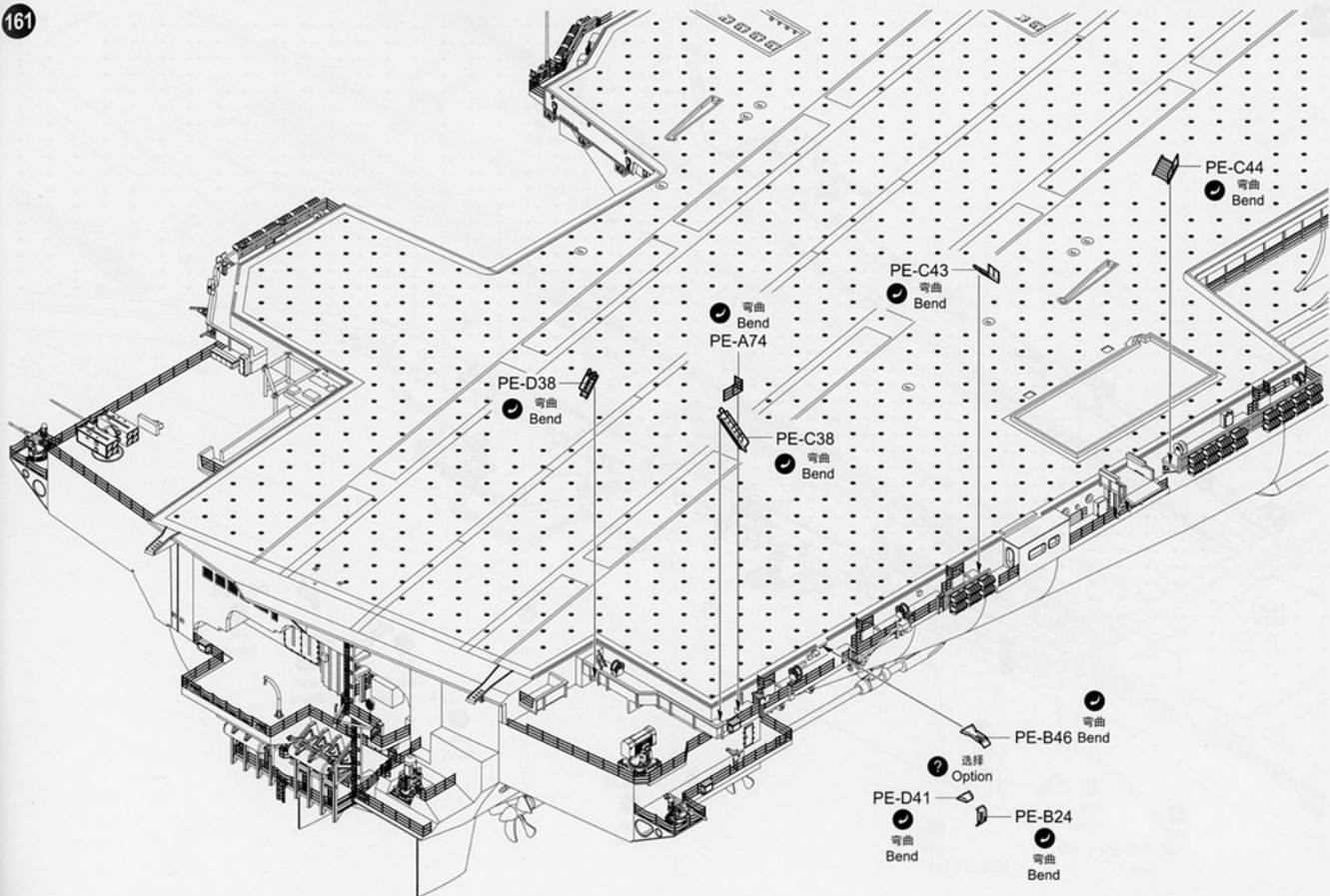

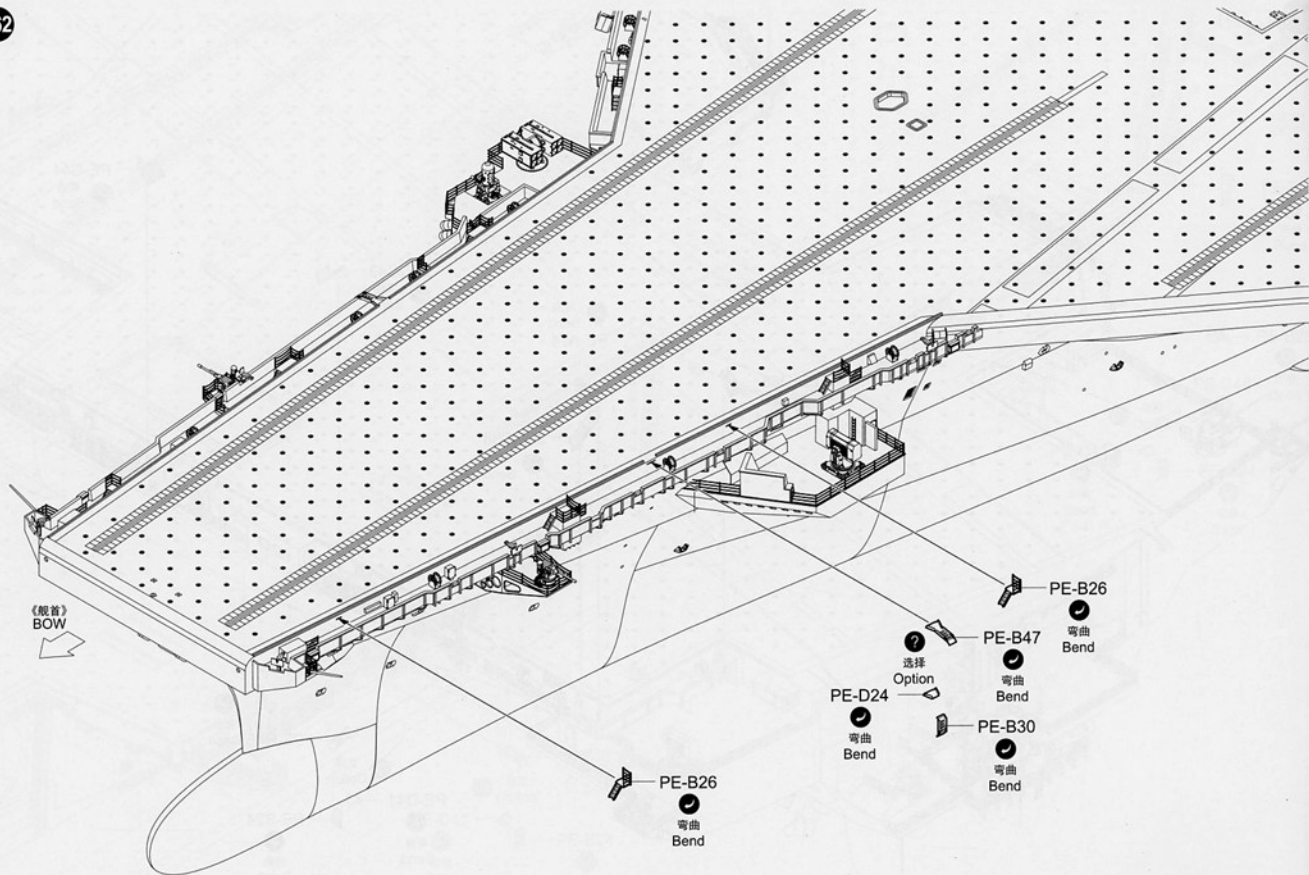

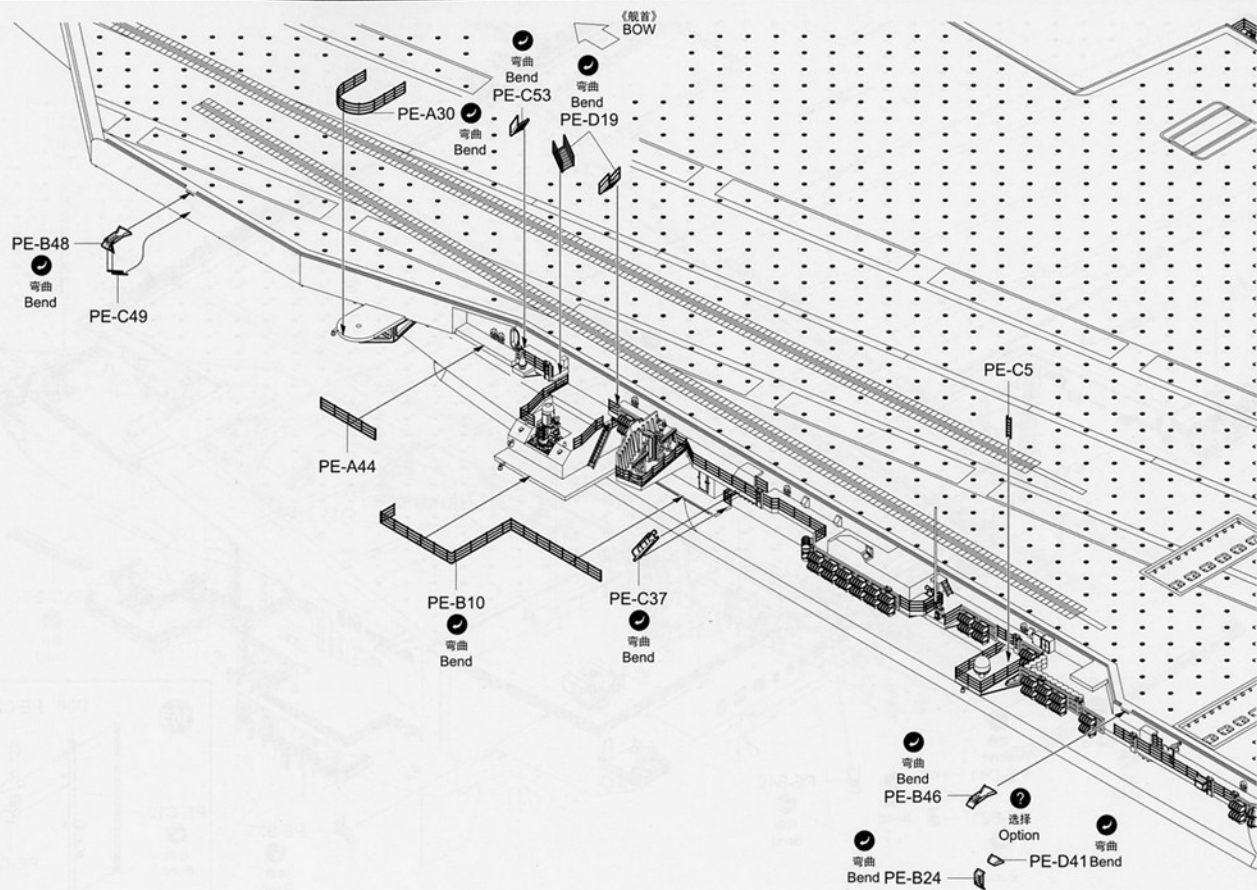

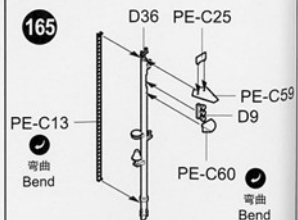
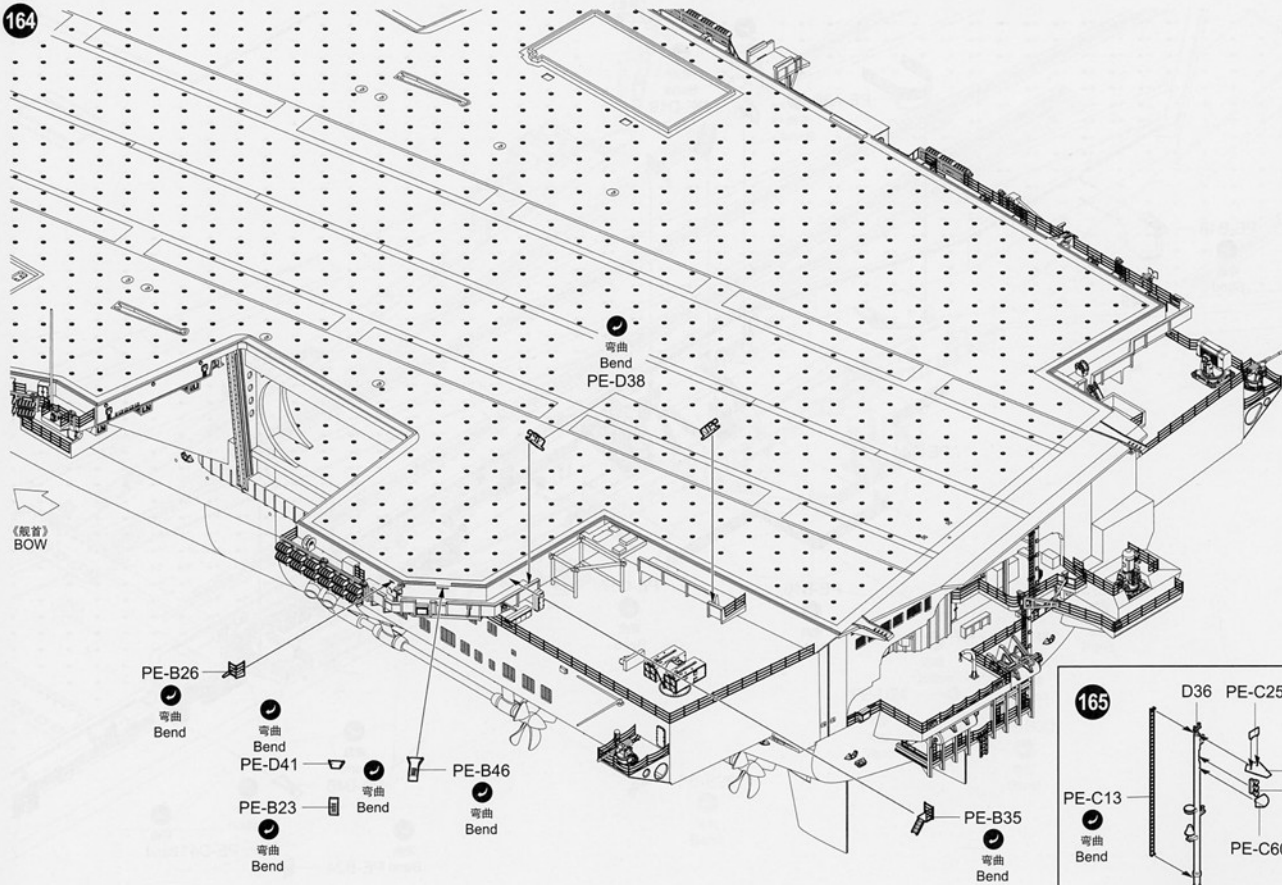

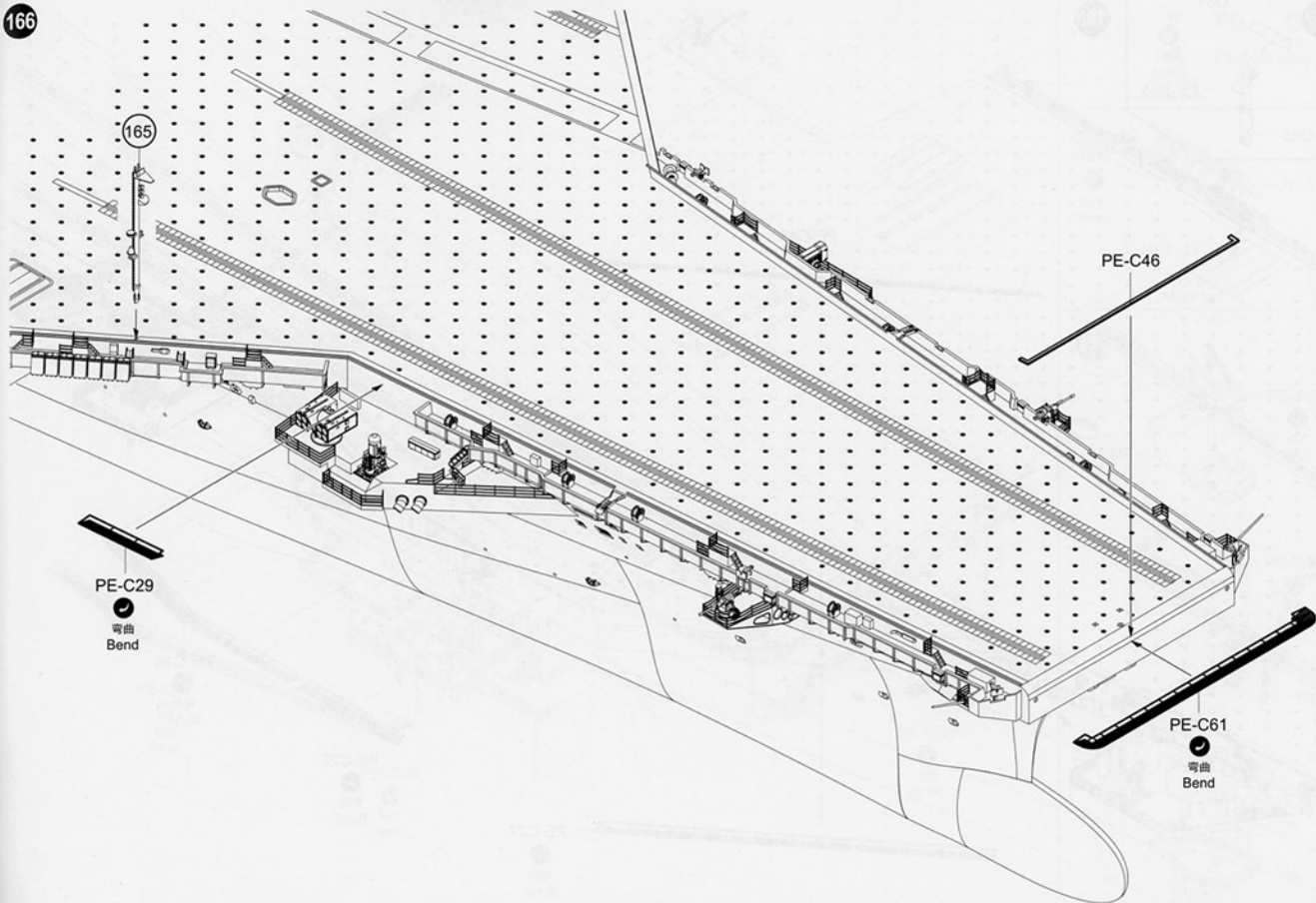

167

D84

168

弯曲
Bend
PE-B34

D85

PE-C45

167

《船首》
BOW

PE-C48

弯曲
Bend

PE-C28

弯曲
Bend

PE-C27

弯曲
Bend

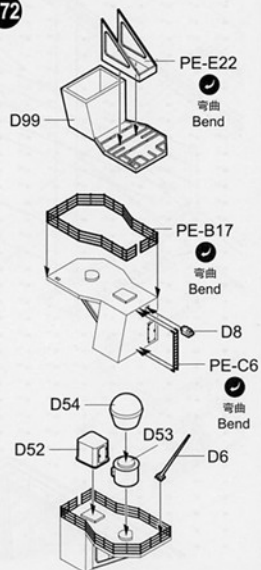
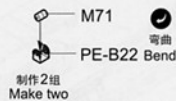
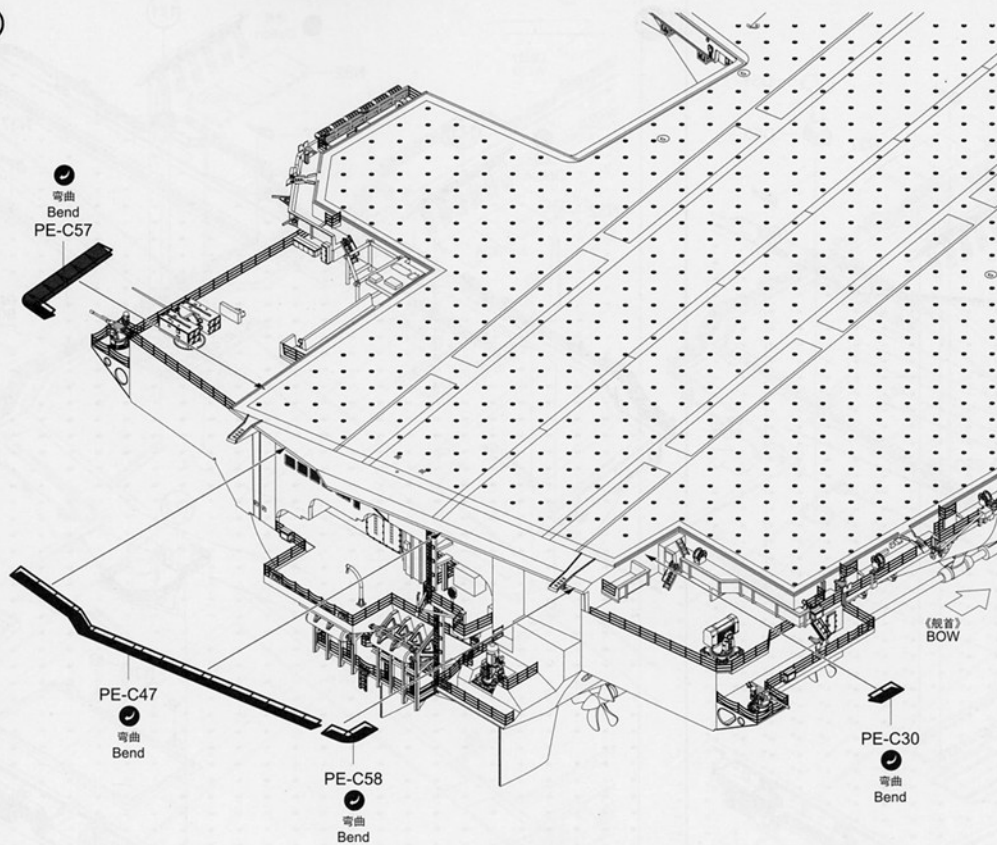

173

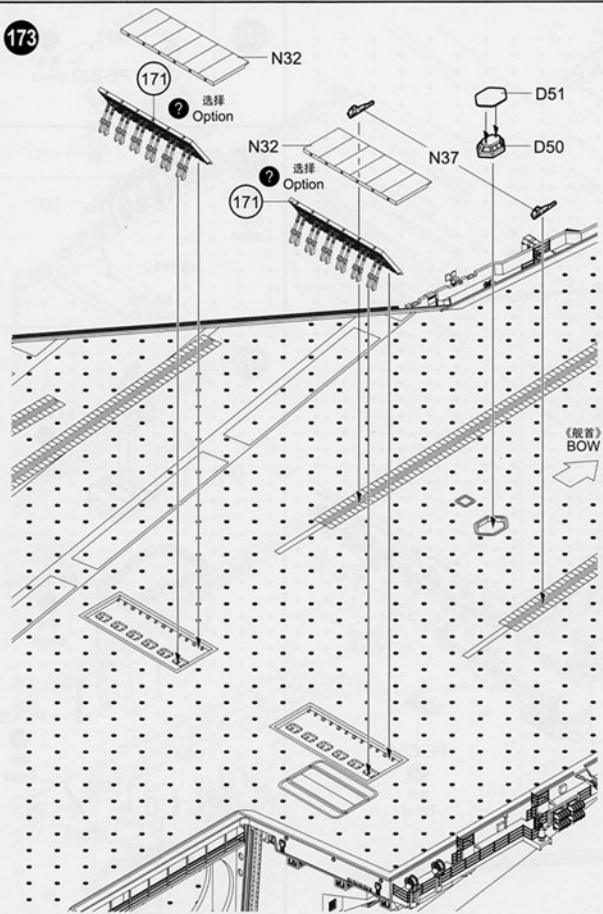

174

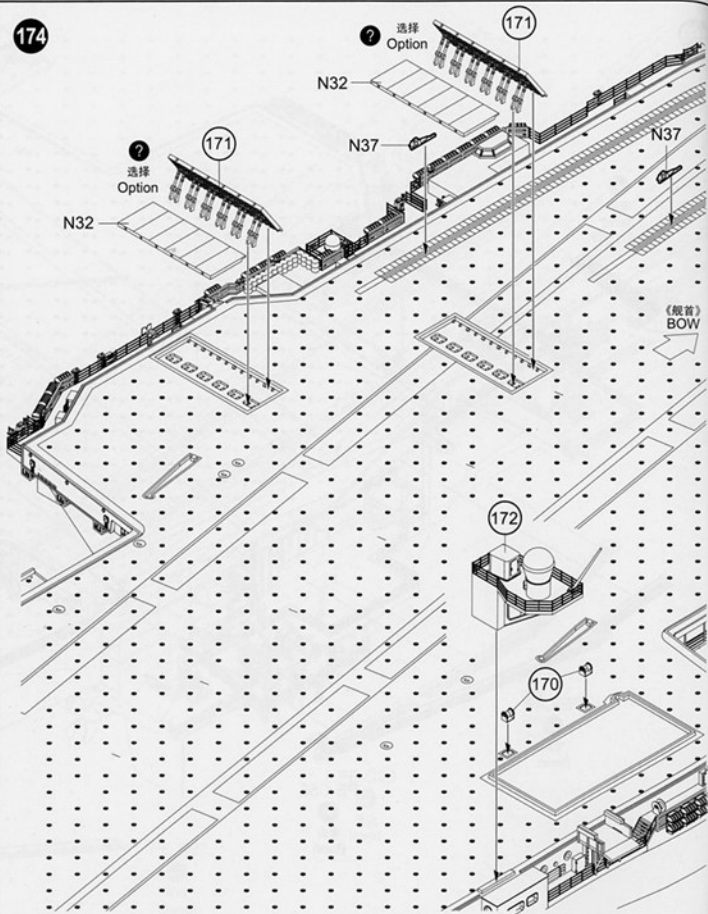

175

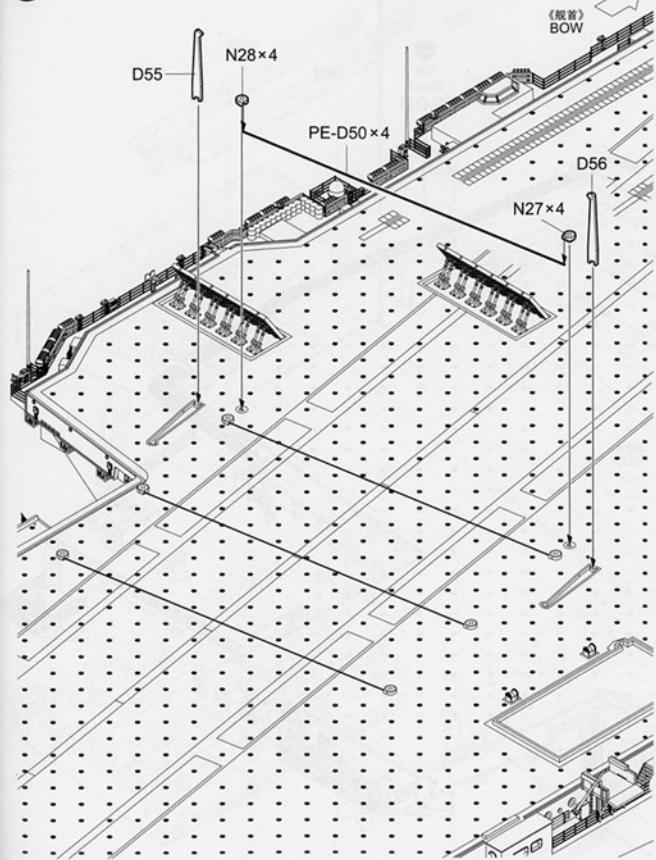

176

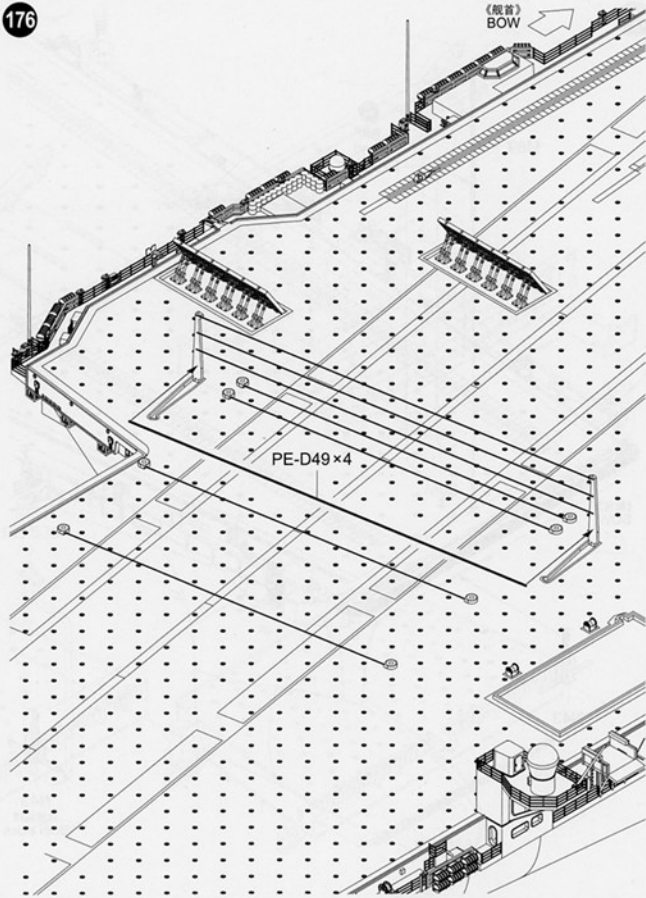

177

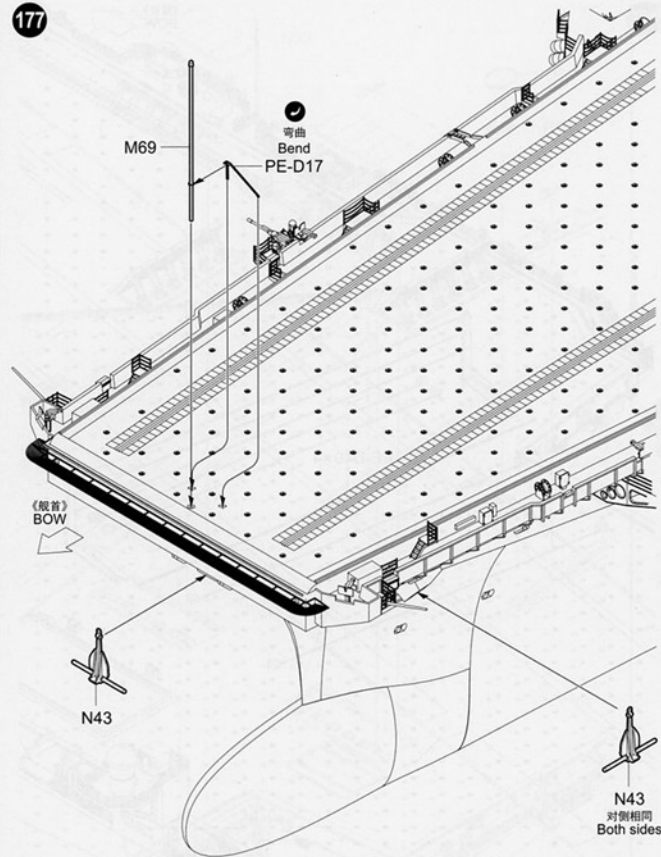

178

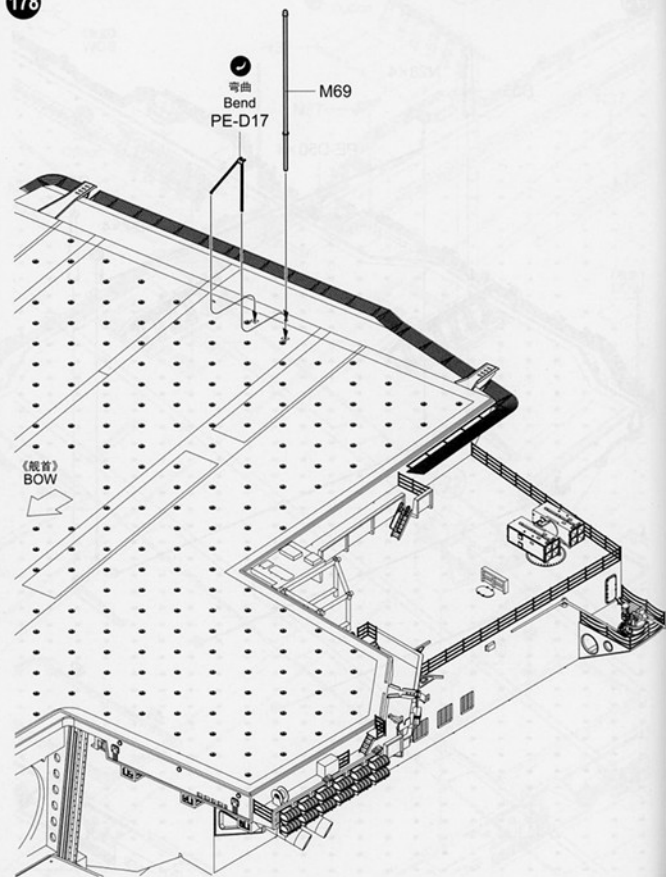

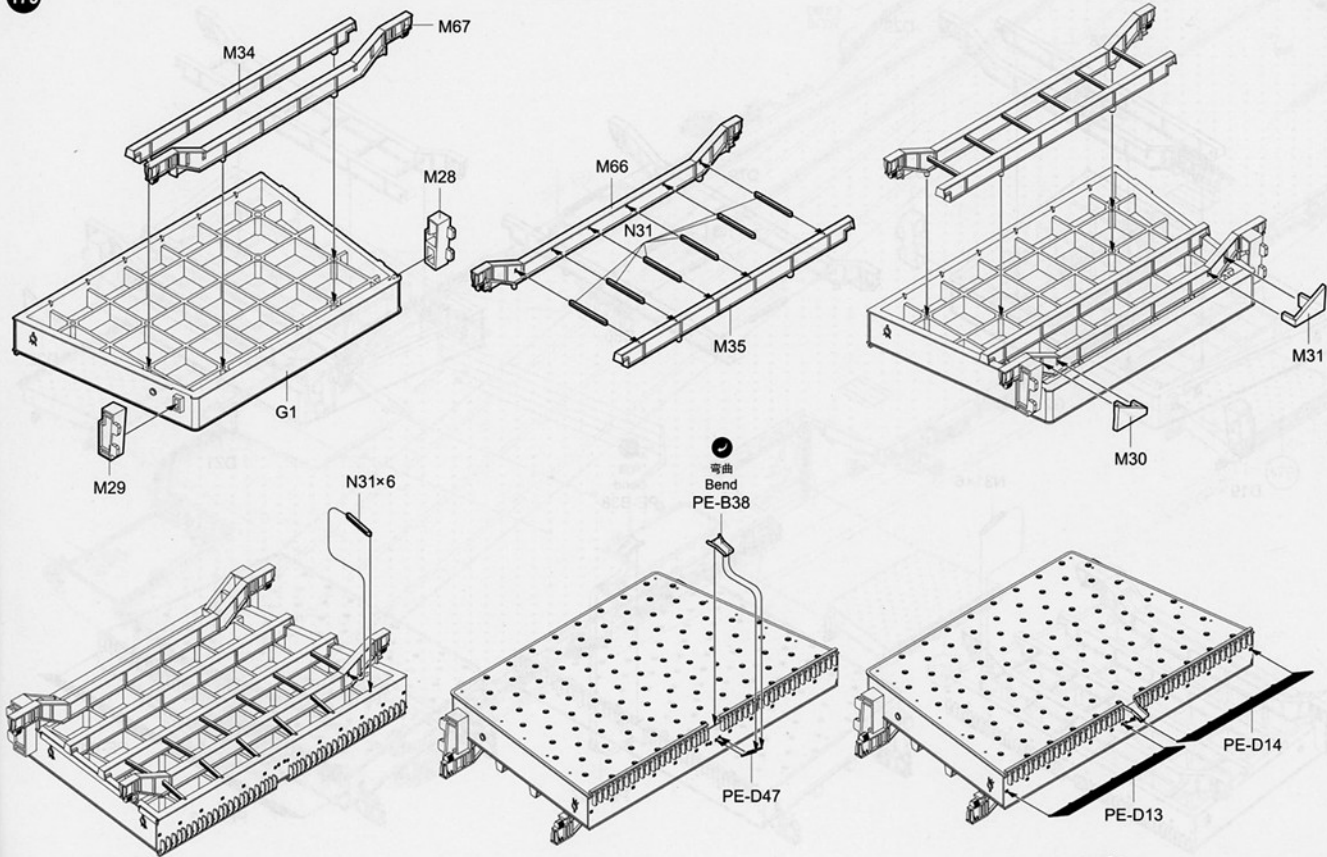

制作2组
Make two

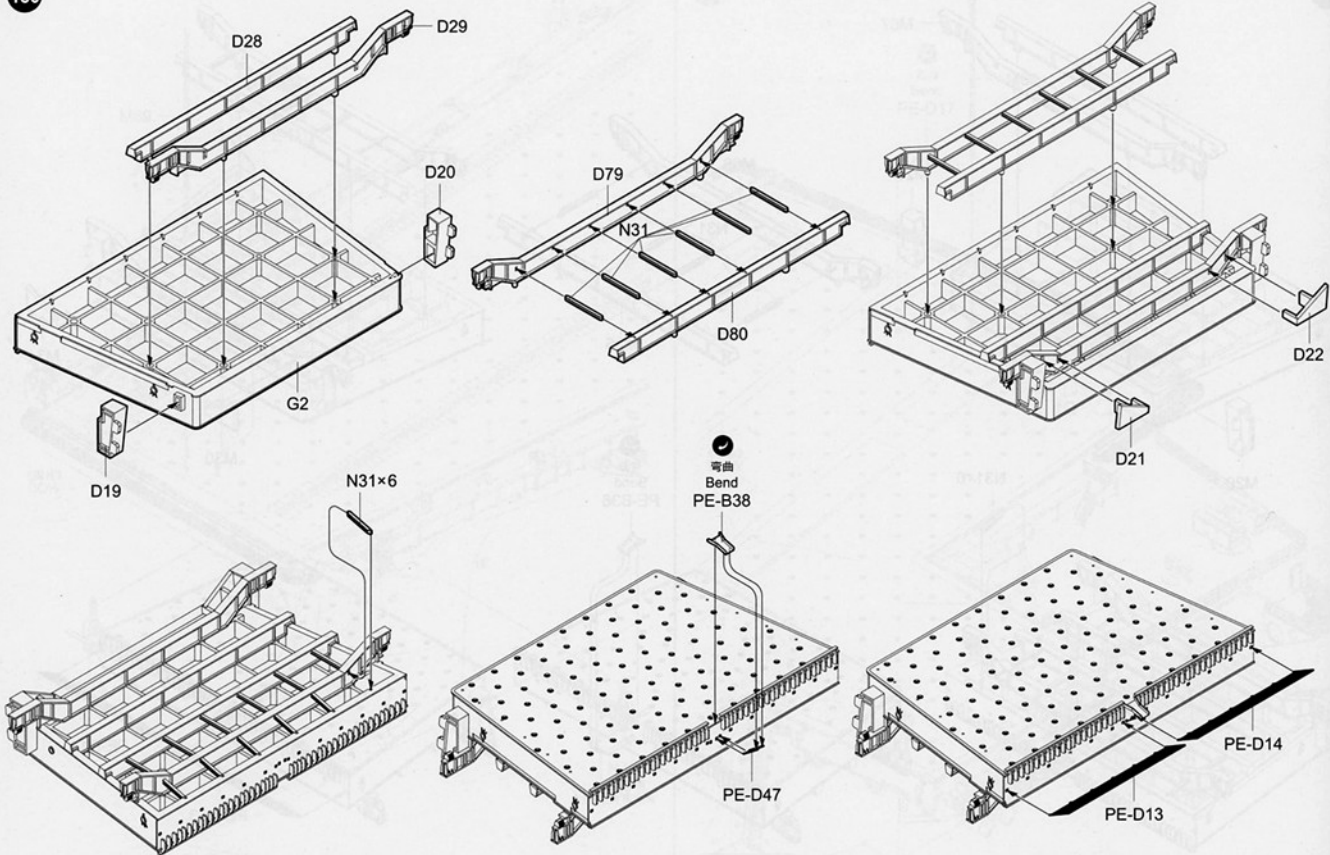

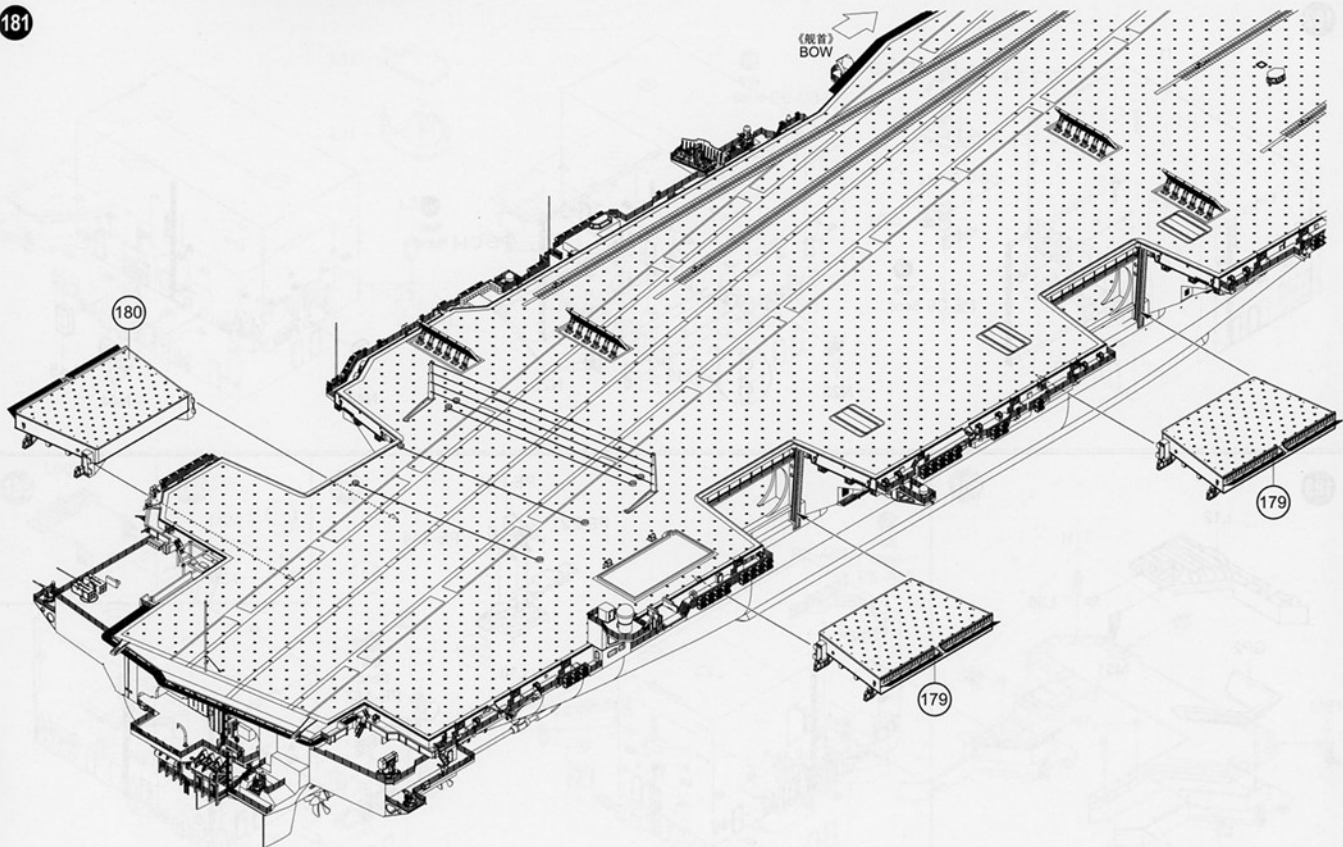

182

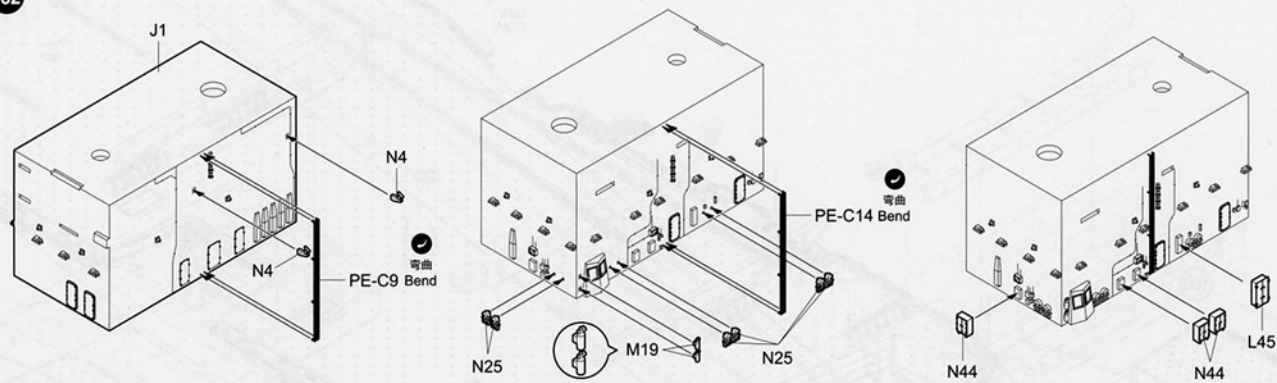

183

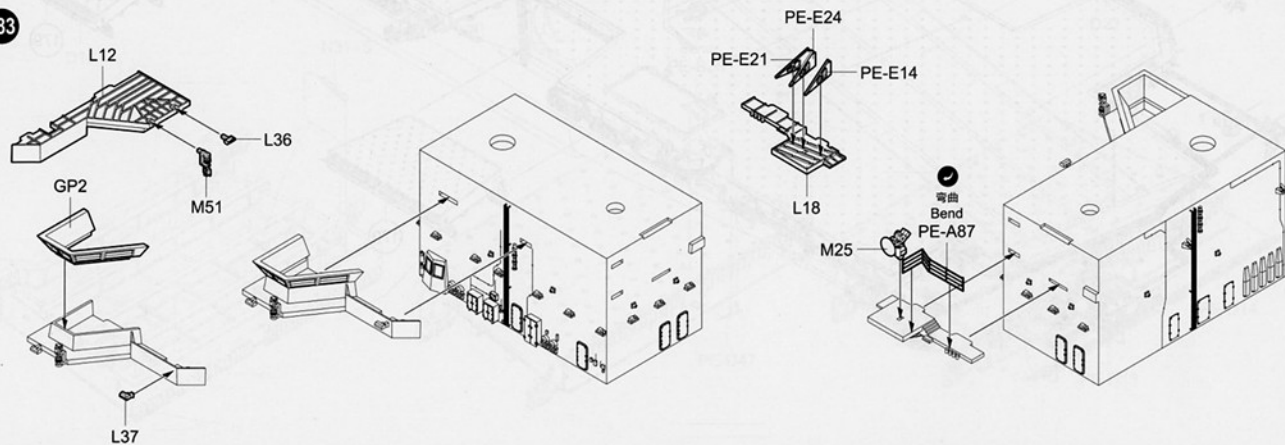

184

L17

L11

L38

弯曲
Bend PE-C34

PE-E23 PE-E13

L55

PE-A60

M25

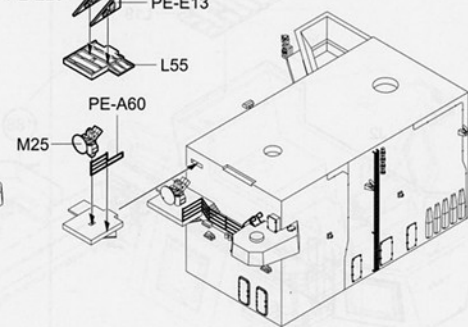
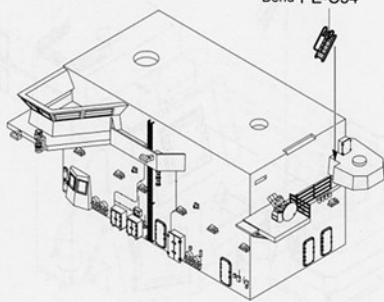
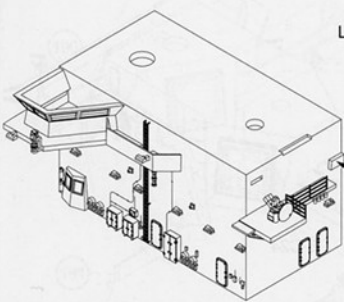

185

L66

N17

186

M24

M54

187

185

186

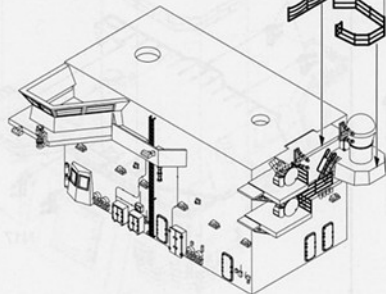
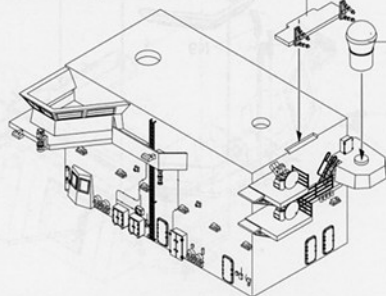

弯曲
Bend PE-A55

188

N17

N7

L9

N17

M51

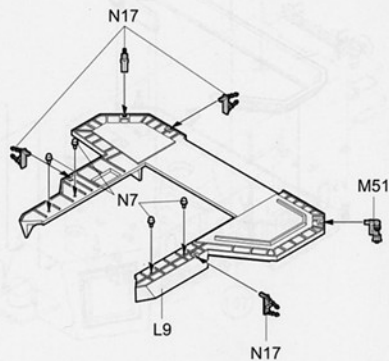

189

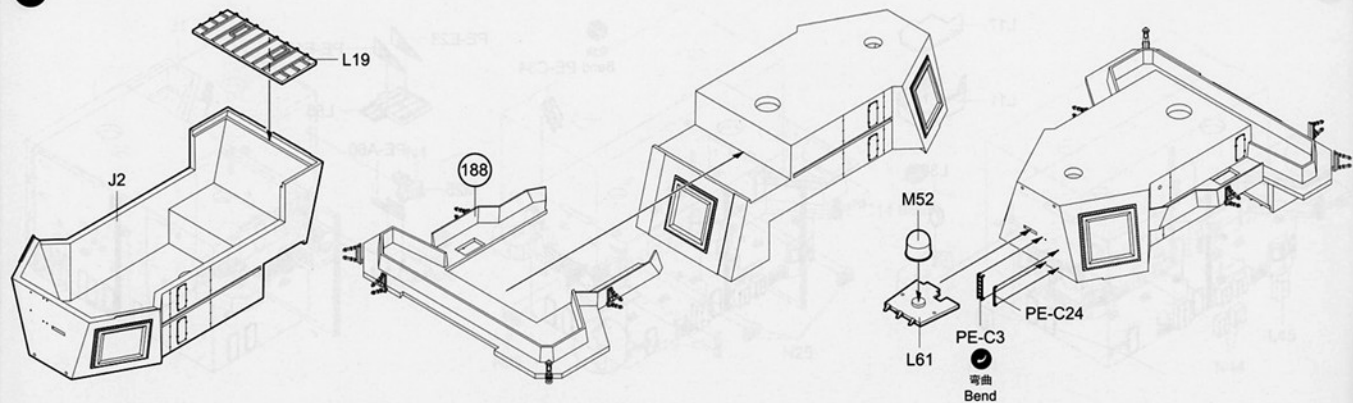

190

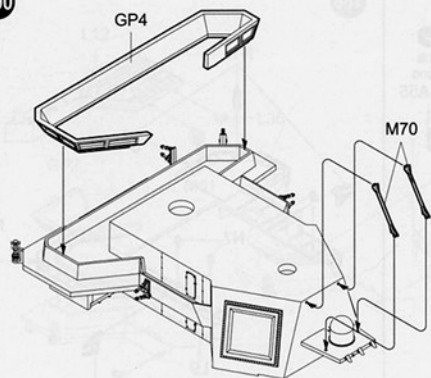

191

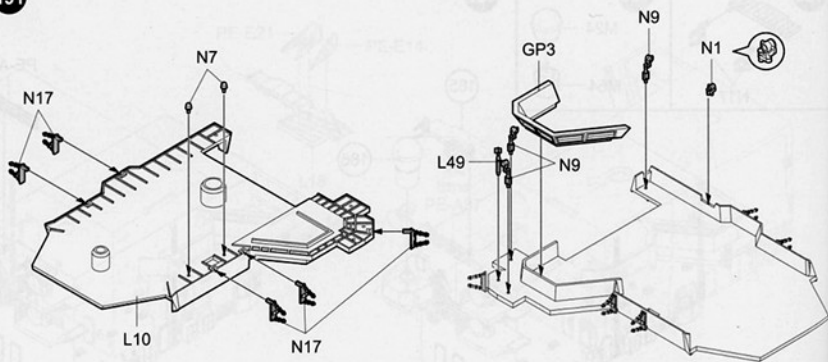

192

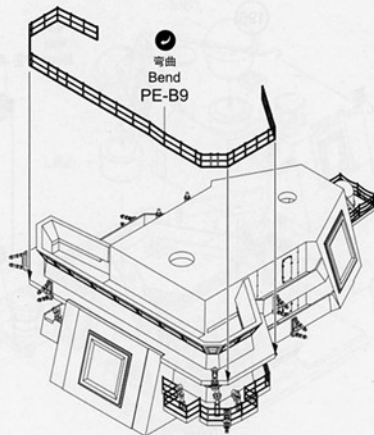
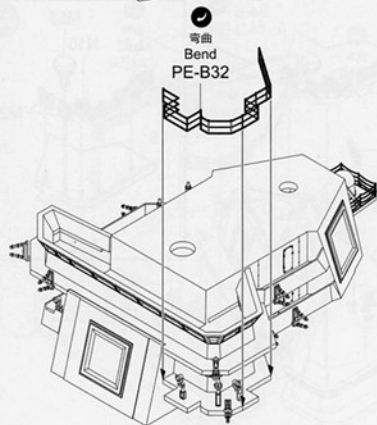
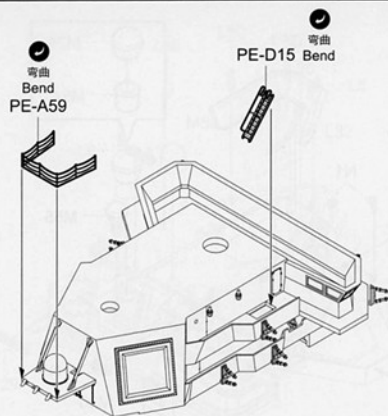
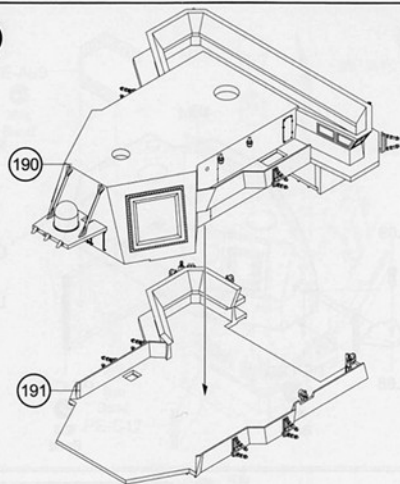

193

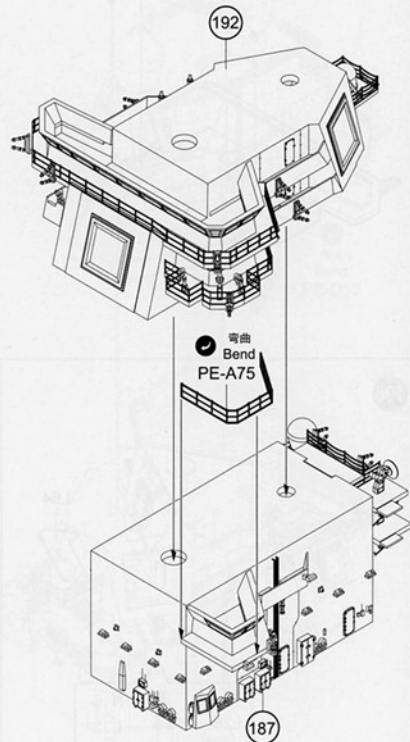

198

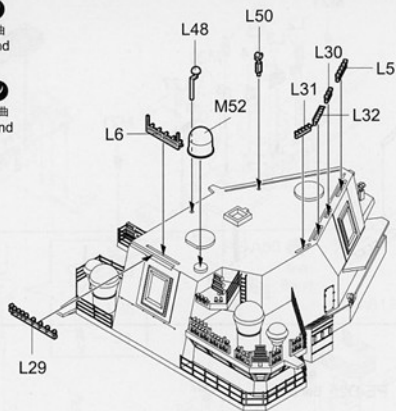
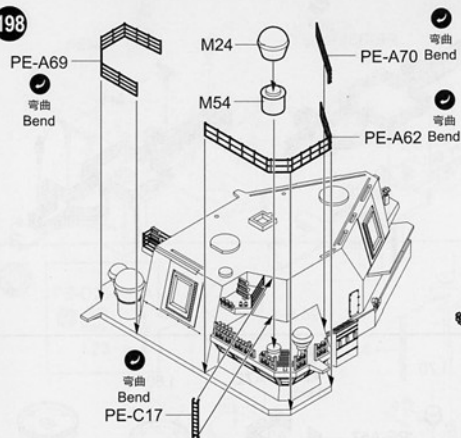

200

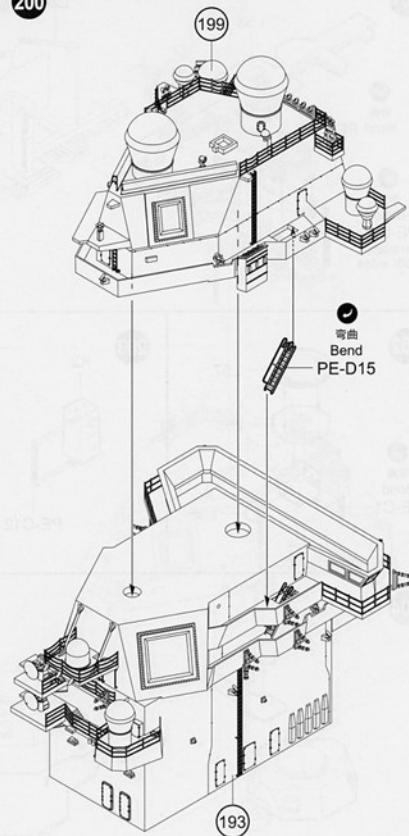

199

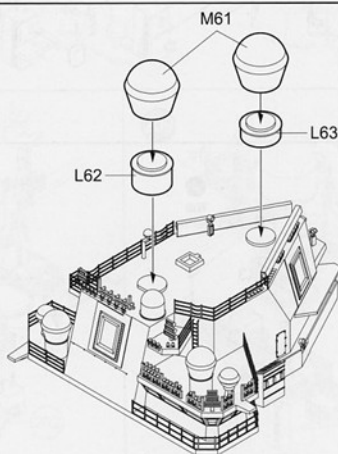
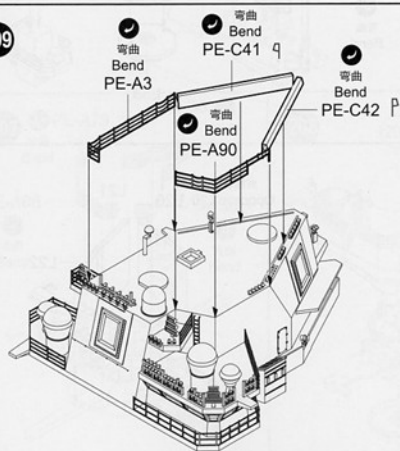

201

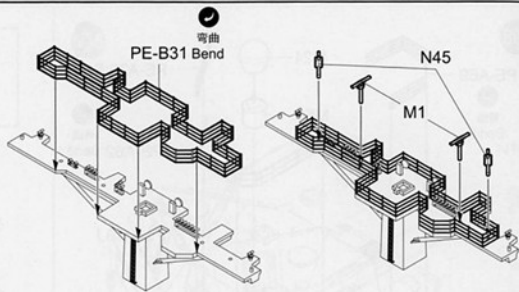
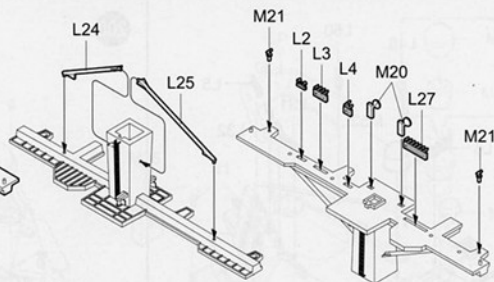
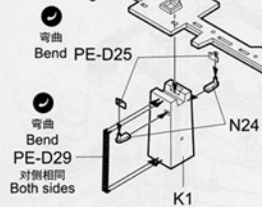

202

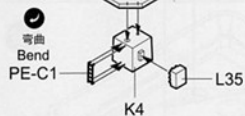

203

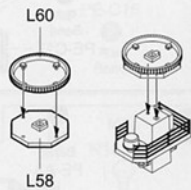
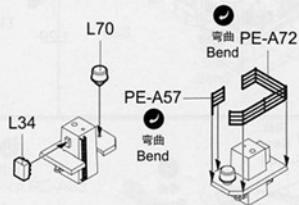
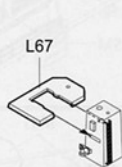
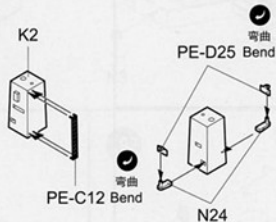

204

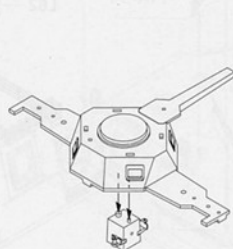
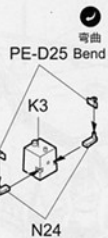
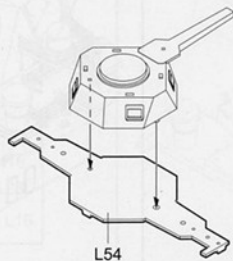

对侧L20
Opposite L20

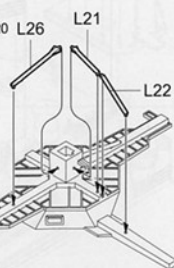

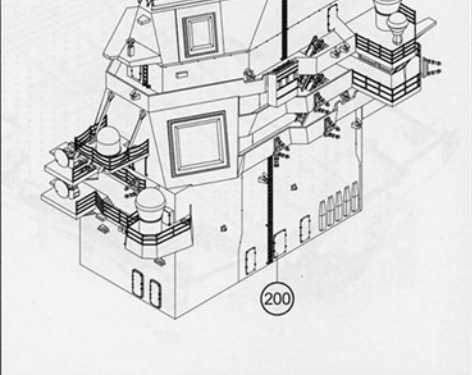
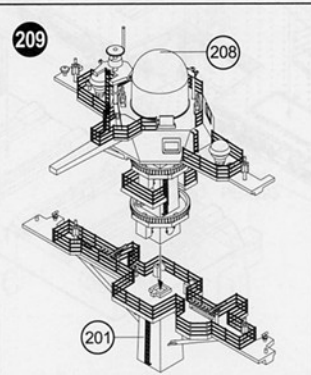
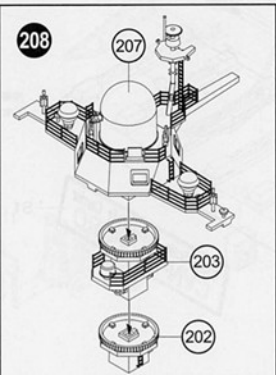
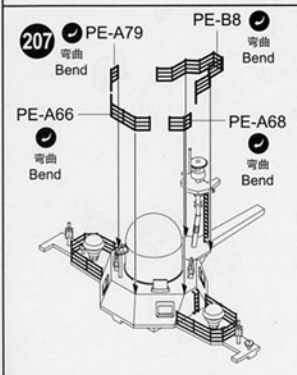
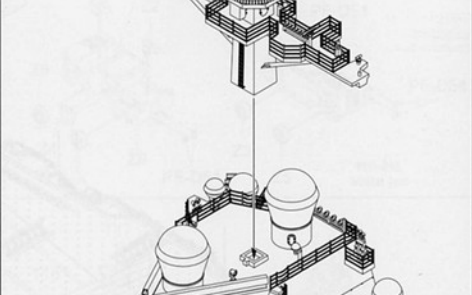
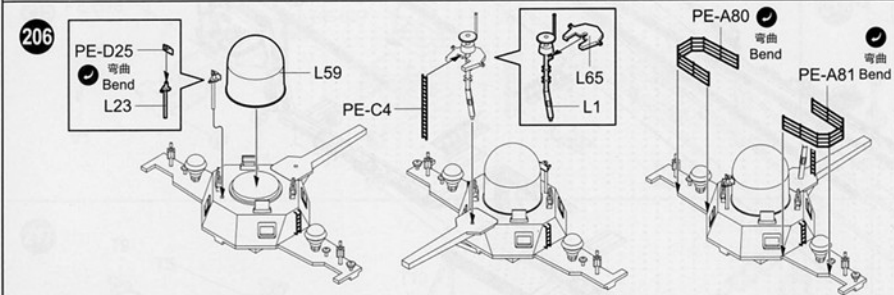
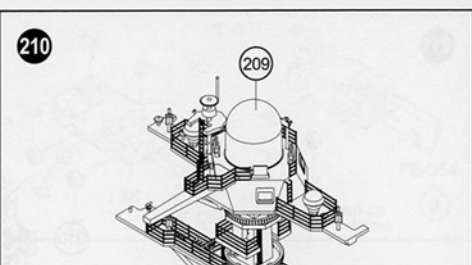
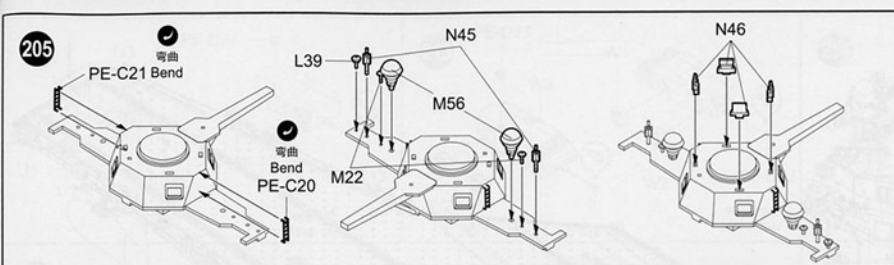

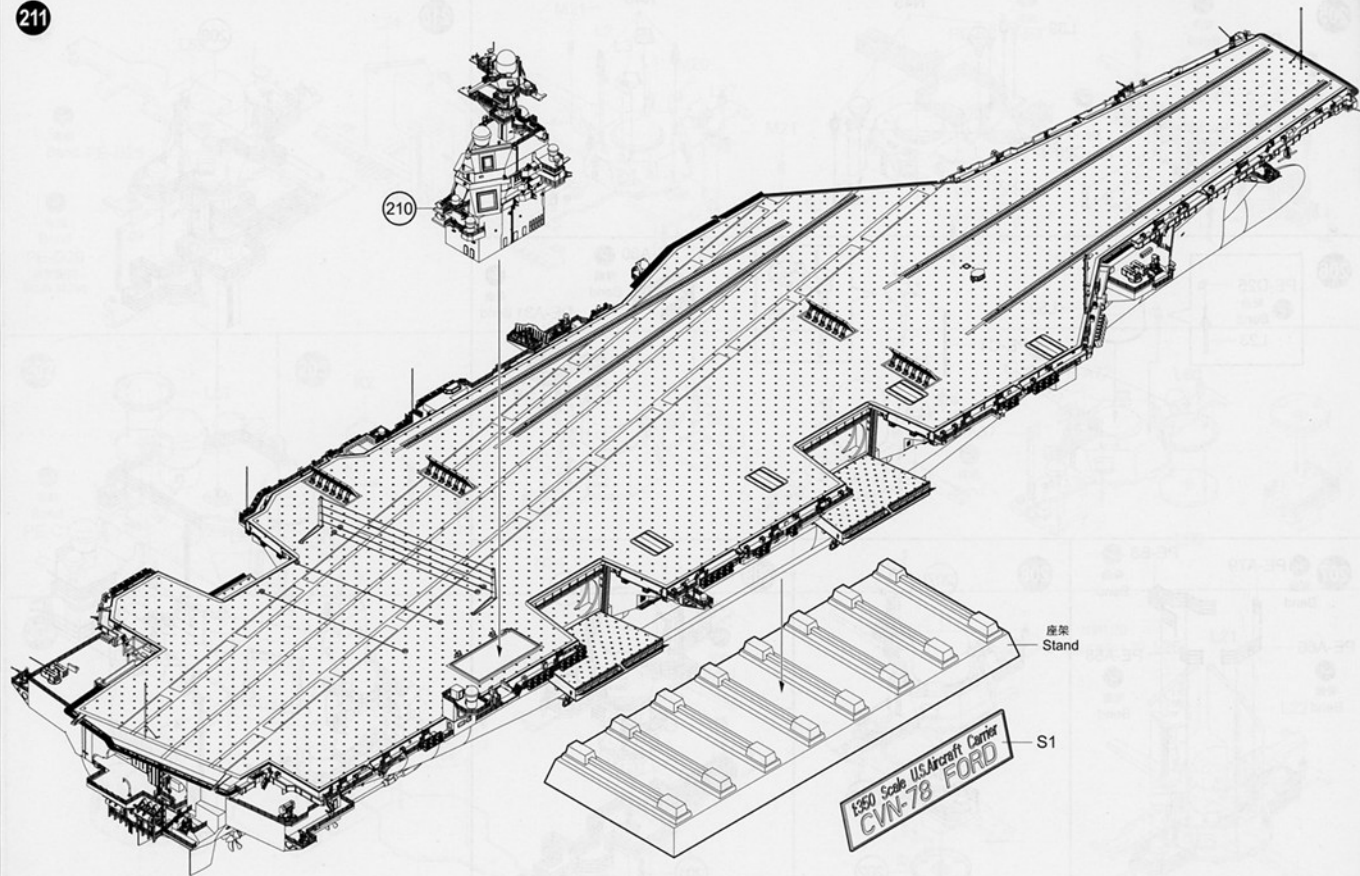

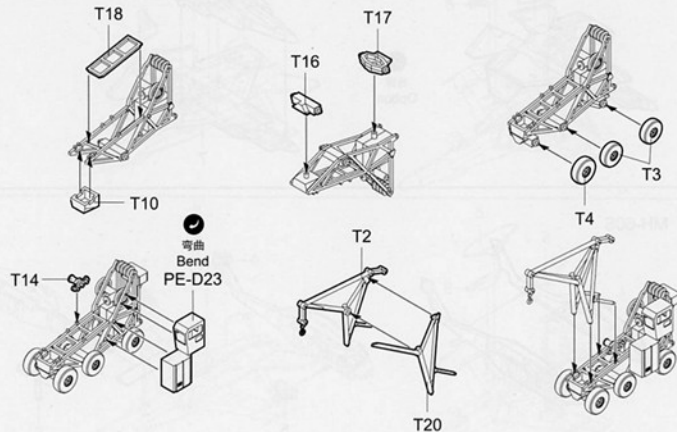
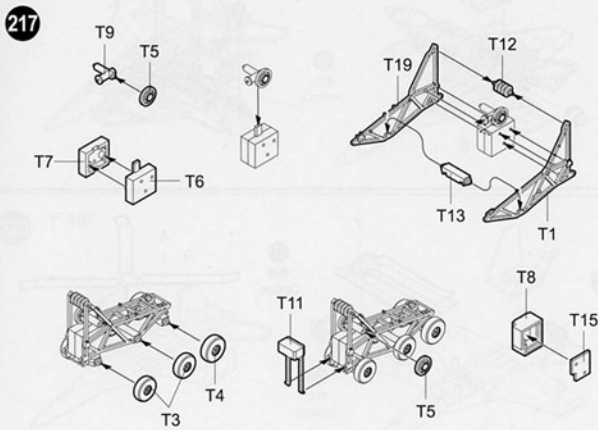
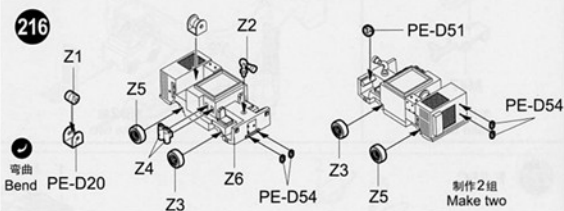
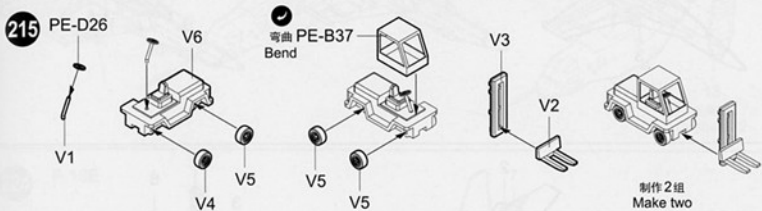
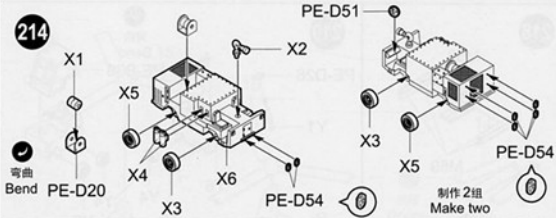
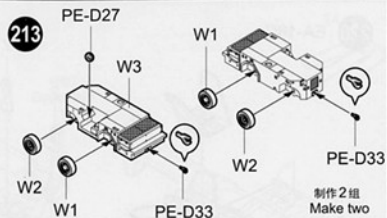
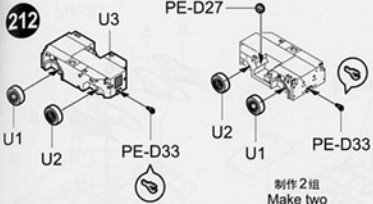

218

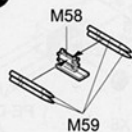

制作2组
Make two

219

PE-D26

Y1

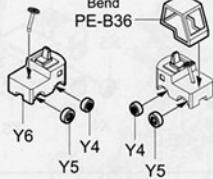

Y3

Y2



制作2组
Make two



弯曲
Bend
PE-B36

220 EA-18G

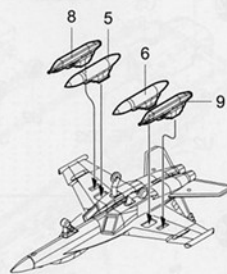
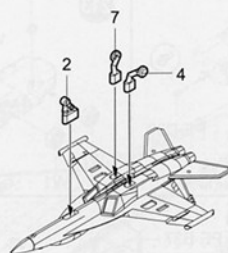
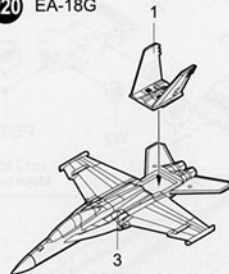

221

F-35C

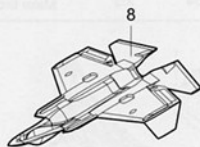

选择
Option

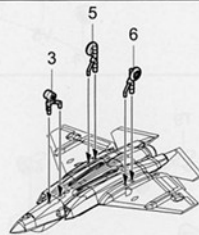
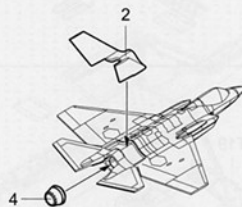
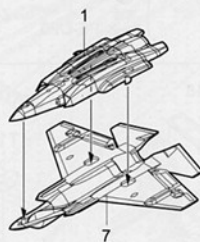

222

MH-60S

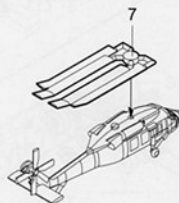
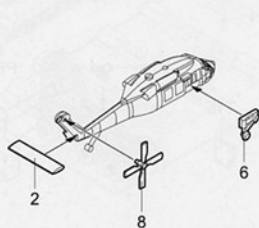
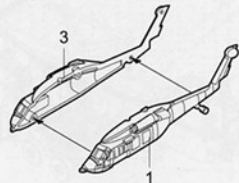

选择
Option

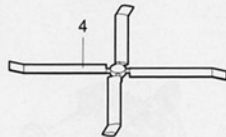

223 MV-22

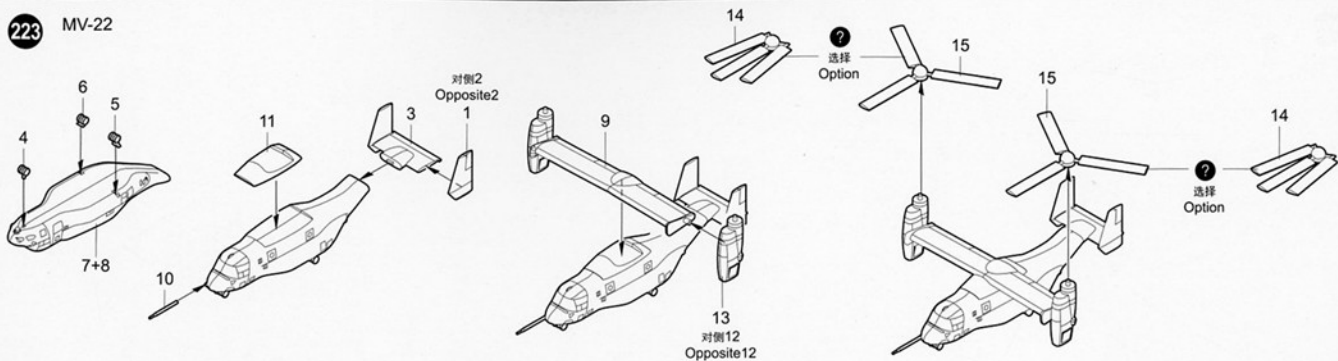

224 F-18E

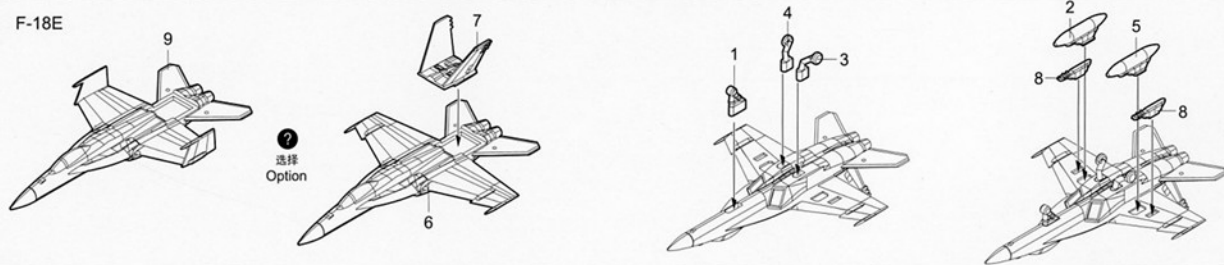

225 F-18F

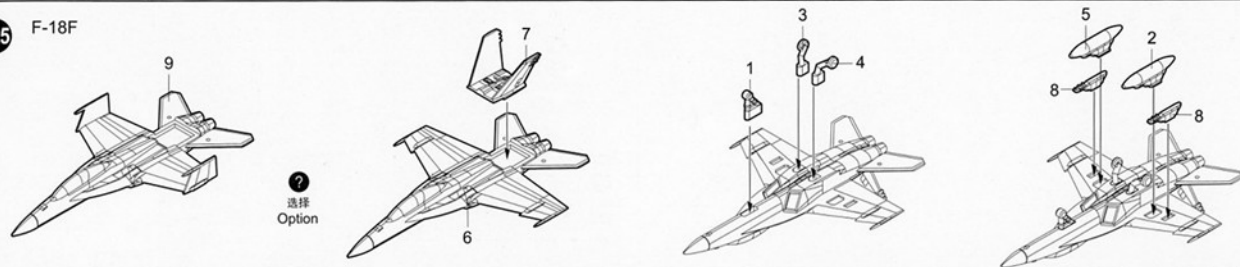

226

E-2D

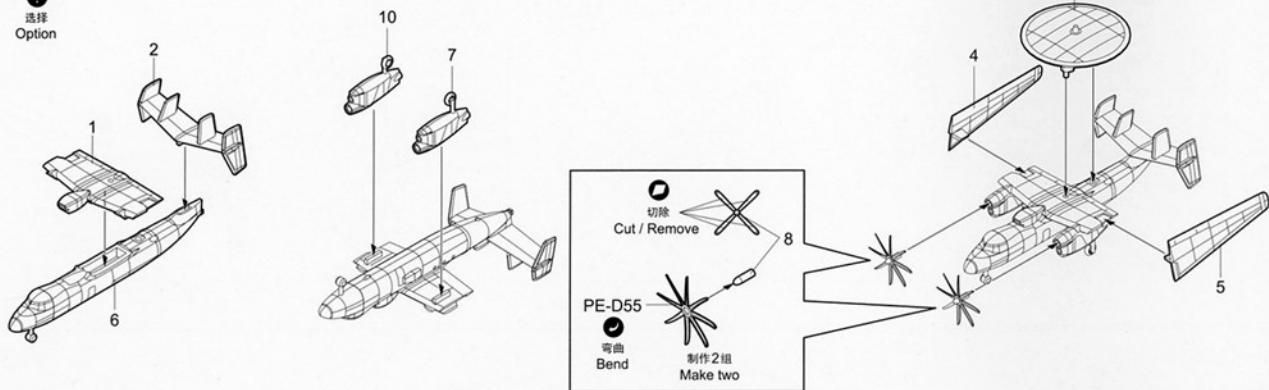
选择
Option

227

E-2D

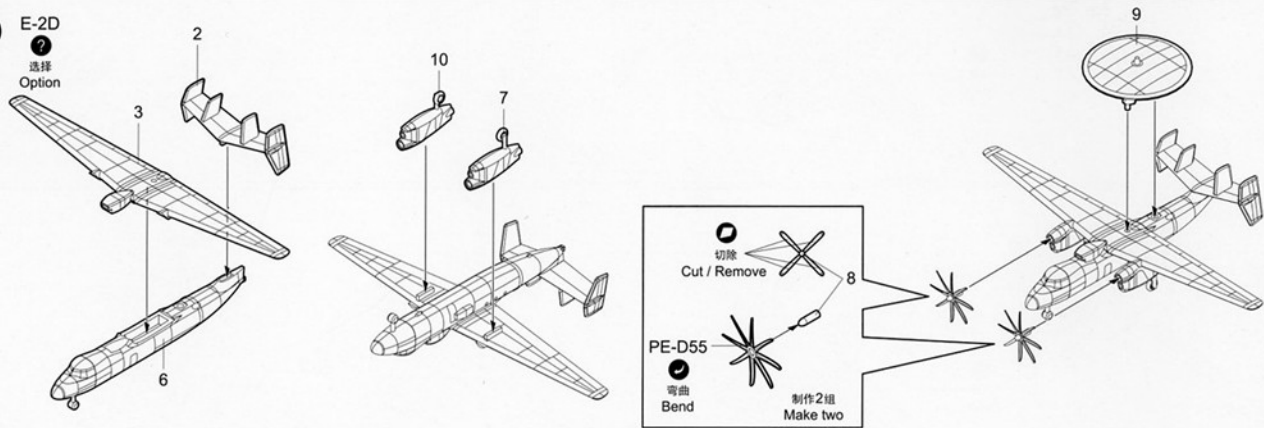
选择
Option

涂装同标贴指示

Painting & Marking guide

PAINT REFERENCE COLOR							PAINT REFERENCE COLOR						
Color	Mr.Hobby	Acrycion	Vallejo	Model Master	Tamiya	Humbrol	Color	Mr.Hobby	Acrycion	Vallejo	Model Master	Tamiya	Humbrol
Flat Black 消光黑	H 12 33	N 12	950	1749	XF1	33	Tire Black 胎黑色	H 77 137	N 77	-	-	XF85	-
Flat White 消光白	H 11 62	N 11	951	1768	XF2	34	Yellow 黄色	H 4 4	N 4	953	1514	X8	69
Gold 金色	H 9 9	N 9	878	1744	X12	16	Ijn Gray 明灰白(1)	H 61 35	N 61	907	1731	-	146
Cocoa Brown 舰底色	H 17 29	N 17	985	-	XF9	177	Red 红色	H 3 3	N 3	908	1503	X7	19
							Off White 淡白色	H 21 69	N 21	918	2709	-	-

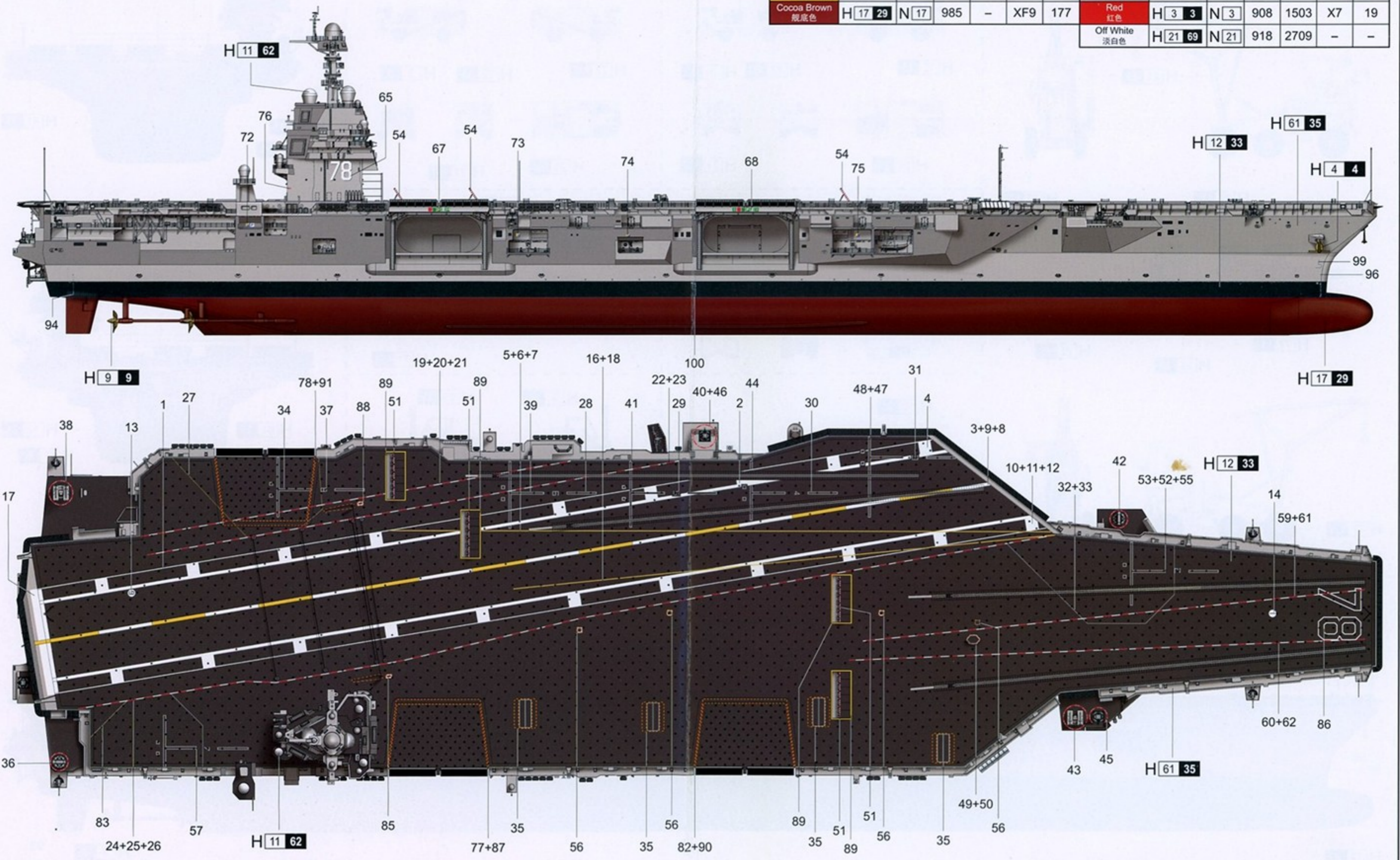

H AQUEOUS HOBBY COLOR Mr. COLOR N ACRYCION COLOR

涂装同标贴指示
Painting & Marking guide

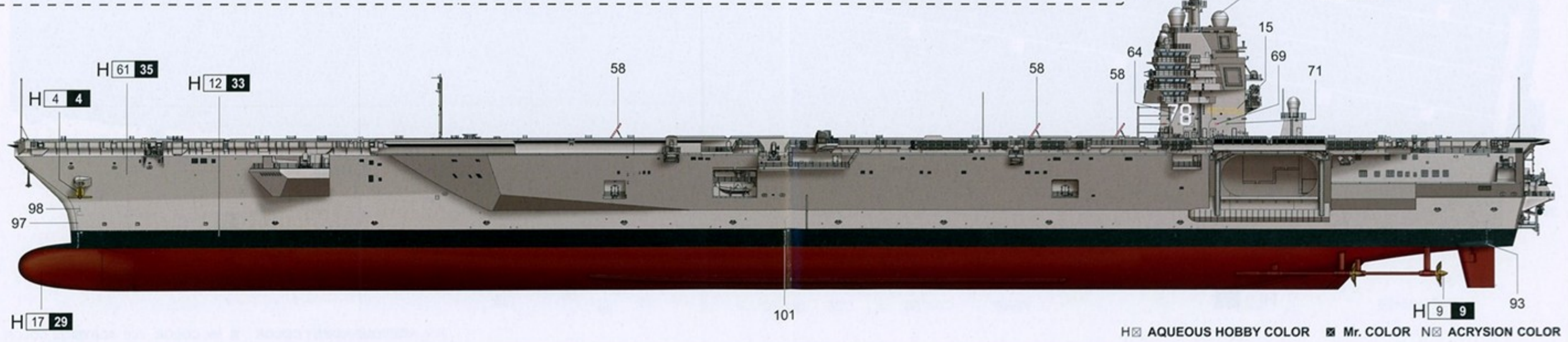
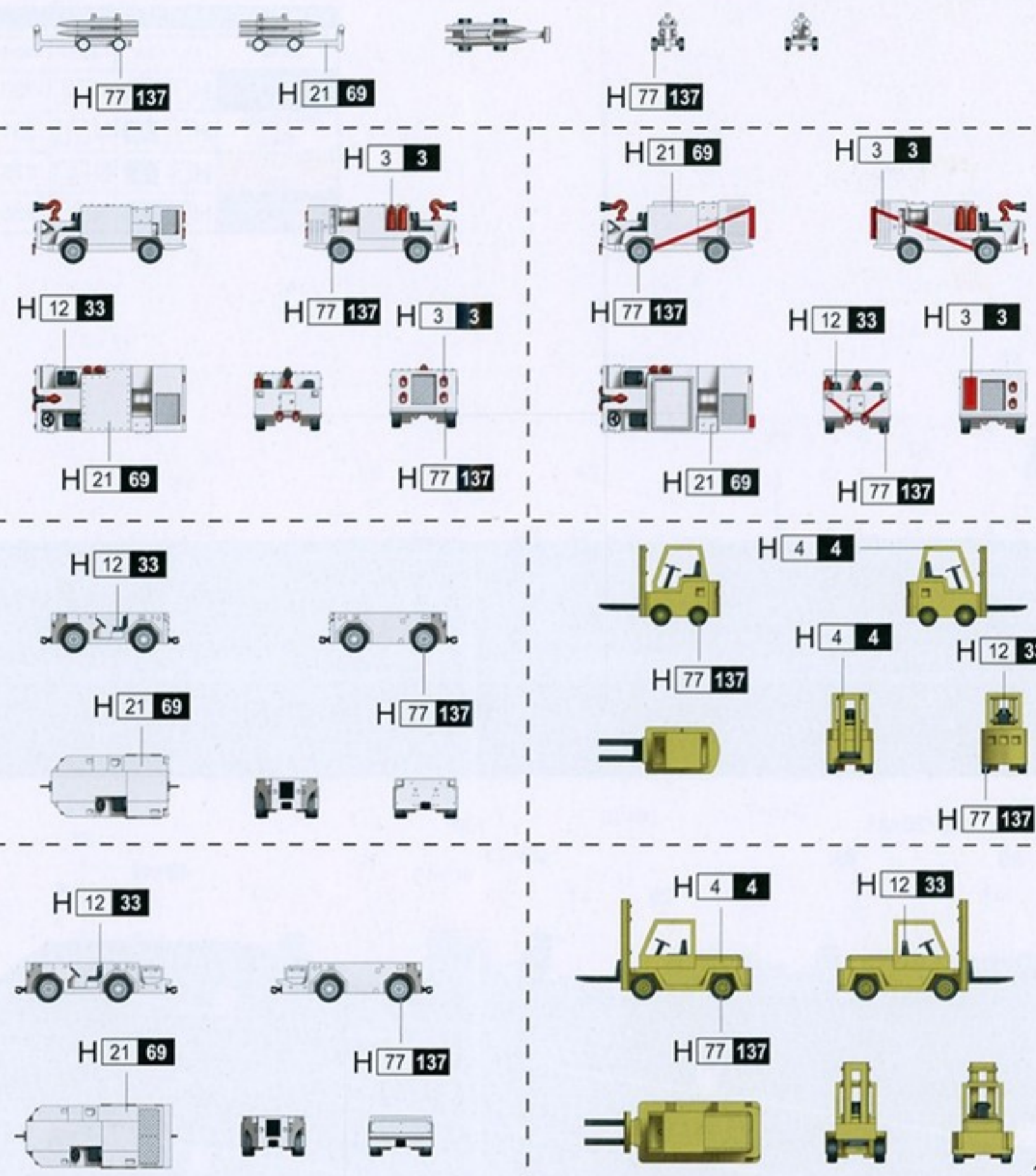
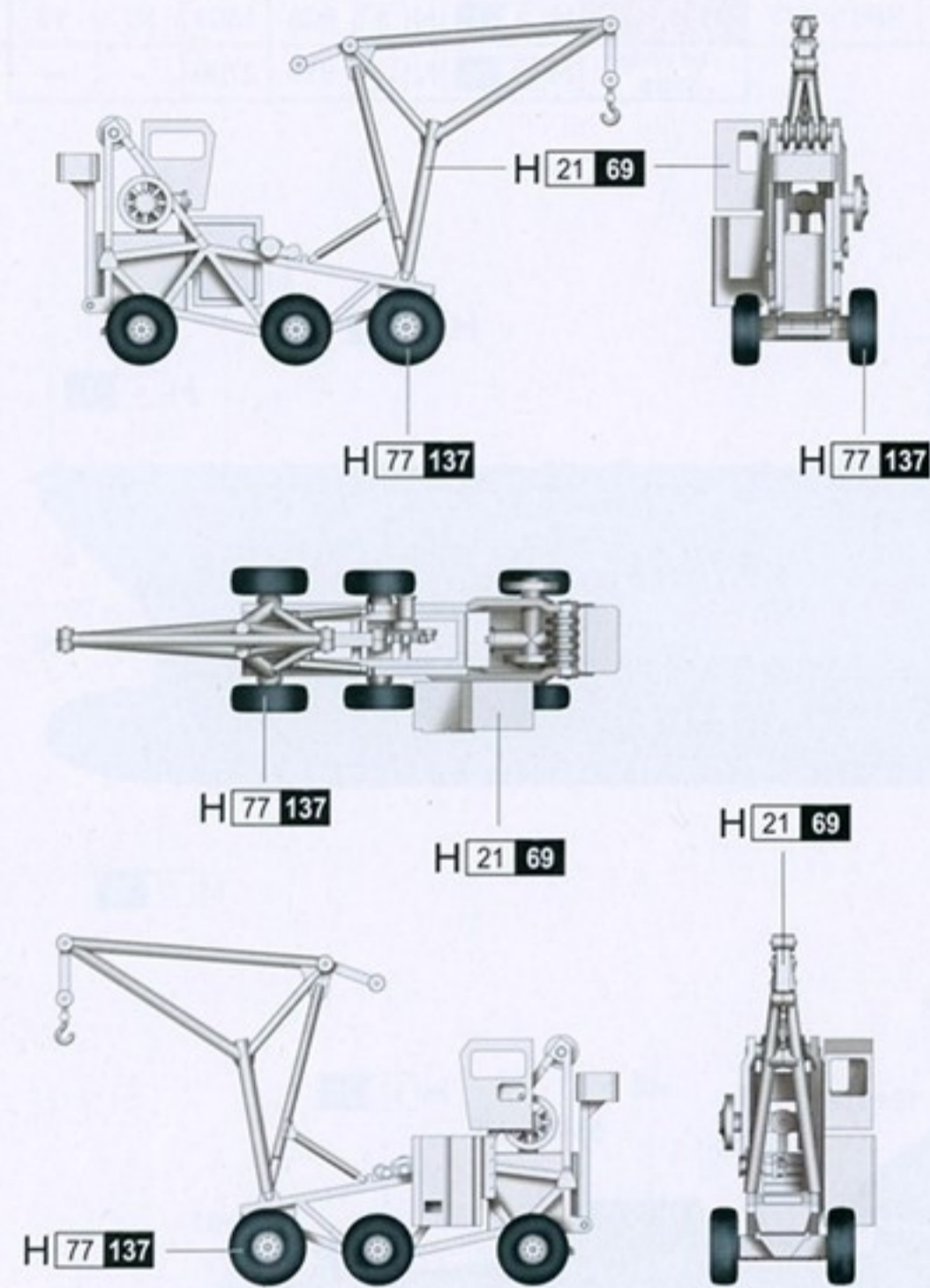

H AQUEOUS HOBBY COLOR Mr. COLOR N ACRYSION COLOR

涂装同标贴指示 Painting & Marking guide

MV-22 x2

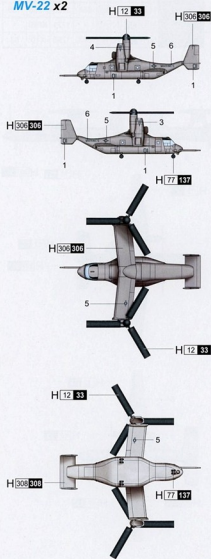

F-18F (VFA-213) x8

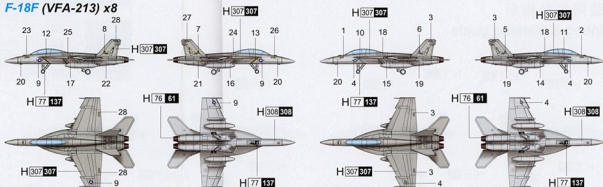

F-35C (VFA-213) x8

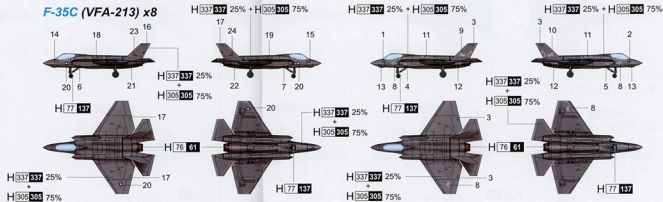

EA-18G (VAQ-142) x4

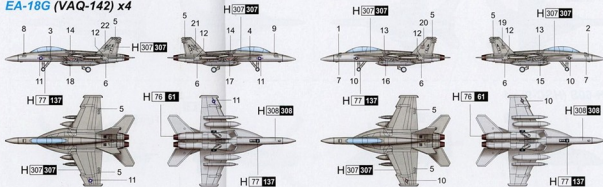

H: AQUEOUS HOBBY COLOR ■ Mr. COLOR N: ACRYLIC COLOR