

“兰开斯特”轰炸机

# LANCASTER >>>>>

## BOMBER



mPLANE-002

MENG KIDS™



## 注意事项 IMPORTANT NOTES

### ⚠ A 注意:

- ☑ 本产品适合的最小年龄为8周岁，8周岁以下制作时应当有家长陪同。
- ☑ 请勿吞食产品包装中的物品，包括但不限于零件、贴纸、包装袋等。
- ☑ 将板件取出后应立即丢弃包装袋，请勿将包装袋置于口鼻处或套在头上，以免引起窒息。
- ☑ 请勿将本产品置于明火或者高温源附近。
- ☑ 本产品内零件可能包含尖角，请注意避免伤害。

### ⚠ A Caution:

- ☑ The product is suitable for modellers aged eight and above. Children under eight must be supervised by a responsible and knowledgeable parent.
- ☑ Don't swallow any items in the package, including but not limited to parts, stickers, decals and plastic bags.
- ☑ Please dispose properly the plastic bags after taking sprues out. To avoid danger of suffocation, keep the plastic bags away from your mouth, nose or head.
- ☑ Keep this product away from fire or high temperature sources.
- ☑ This product may contain parts which have sharp points. Please be careful not to get injured.

### ⚠ B 制作前必读

- ☑ 本产品组装时不需要借助任何工具。
- ☑ 组装前请仔细阅读手册，并按照手册标明的步骤进行制作。
- ☑ 确定零件编号后再将其从板件上取下，请勿一次取下多个零件，以免丢失或混淆。
- ☑ 如需涂装，请在通风环境下进行，并按照涂料的注意事项操作。

### ⚠ B Read carefully before assembly

- ☑ No tool is needed for assembly of this product.
- ☑ Please read carefully and fully understand the manual before starting assembly.
- ☑ Check part numbers before removing parts from sprues. To avoid missing or mixing up some parts with other items, don't remove many parts at a time.
- ☑ If you need to paint this model, please paint in a ventilated environment, and follow the painting notices.



# 零件图 PARTS

A PARTS

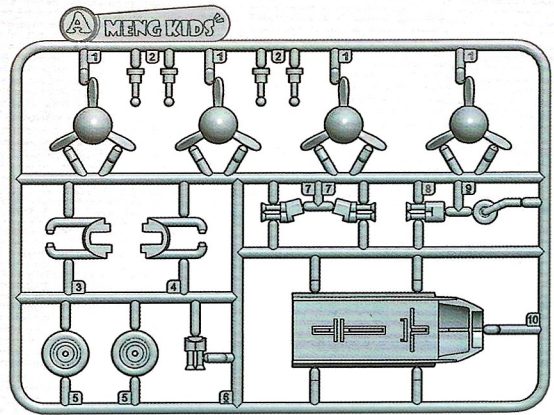

C PARTS

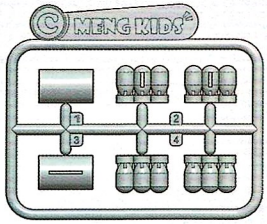

B PARTS

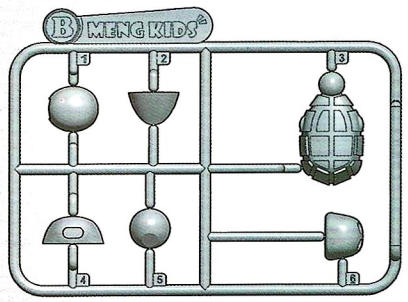

LW

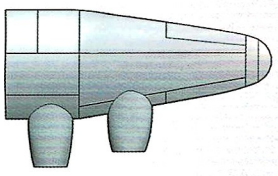

RW

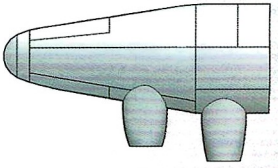

BF

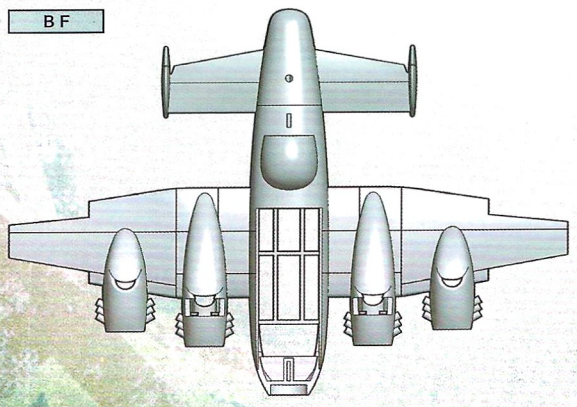

TF

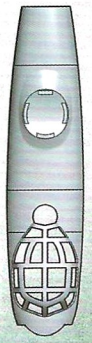

## 炸弹及弹舱组装 BOMB AND BOMB BAY ASSEMBLY

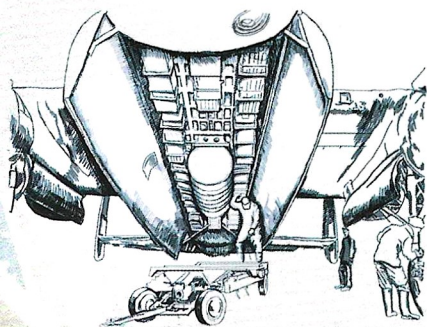
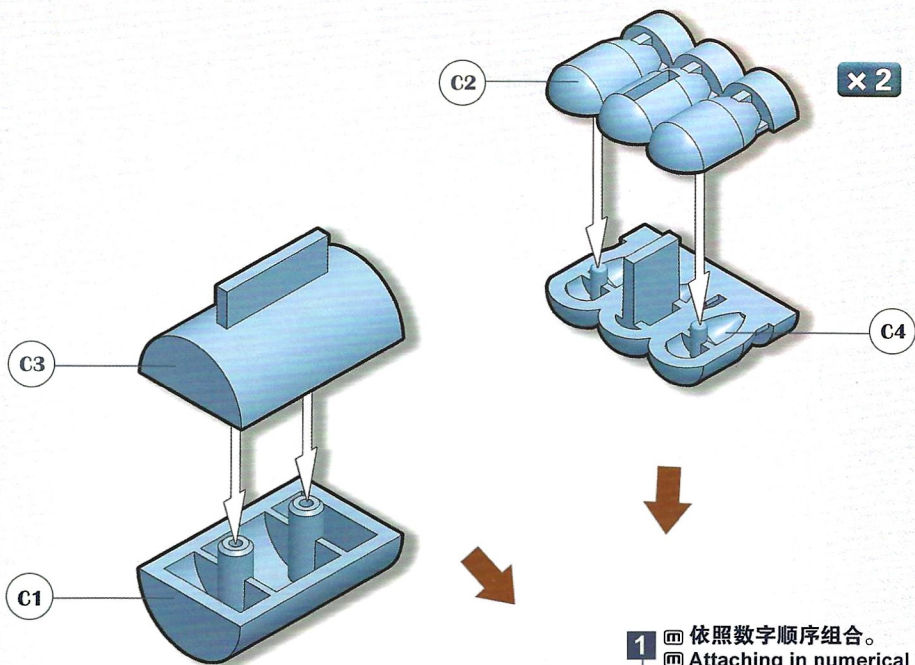

“兰开斯特”一般会混合挂载多种炸弹，最大的那个被戏称为“小馅饼”。

The Lancaster usually carried a mix of different bombs. The biggest one was called "Cookie".

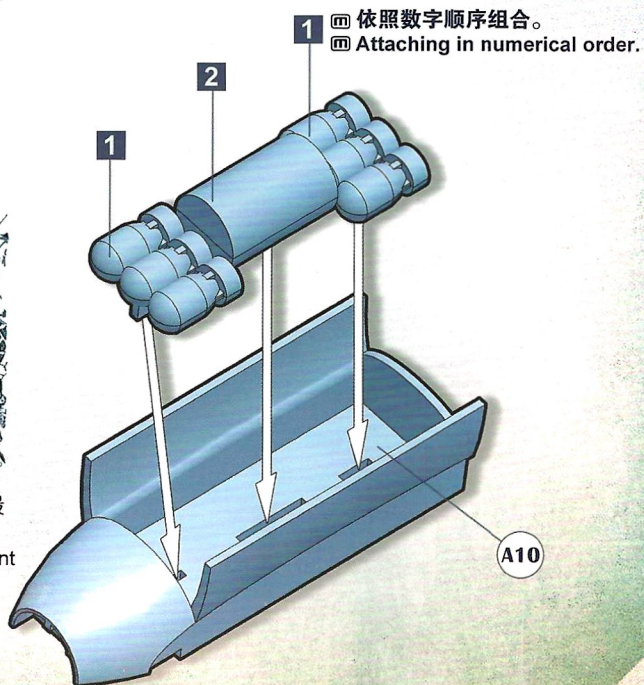

## 机腹设备组装 BELLY EQUIPMENT ASSEMBLY

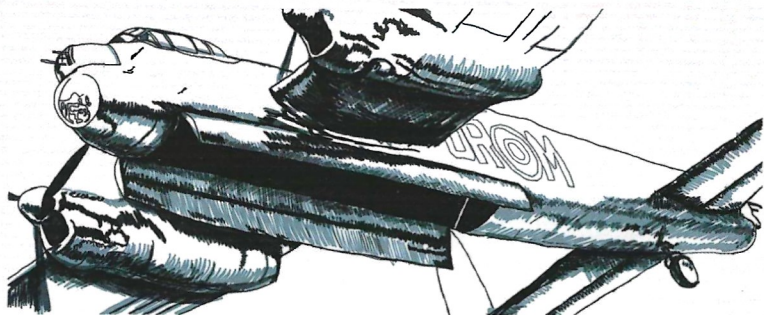

“兰开斯特”的弹舱尺寸巨大，长达十余米，几乎相当于飞机全长的一半。

The Lancaster's huge bomb bay was more than 10m long. That's almost half the length of the bomber.

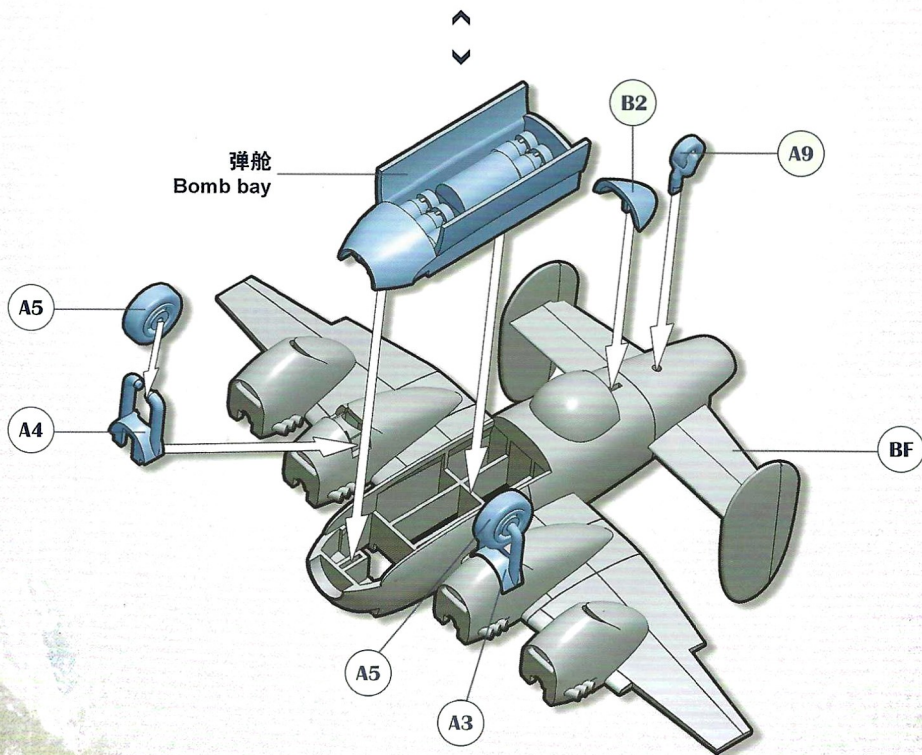

# 3

## 机身顶部组装 FUSELAGE TOP ASSEMBLY

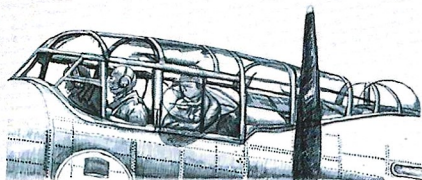

“兰开斯特”采用“花房”式座舱，外观就像一个玻璃暖房。

The Lancaster had a distinctive greenhouse cockpit.

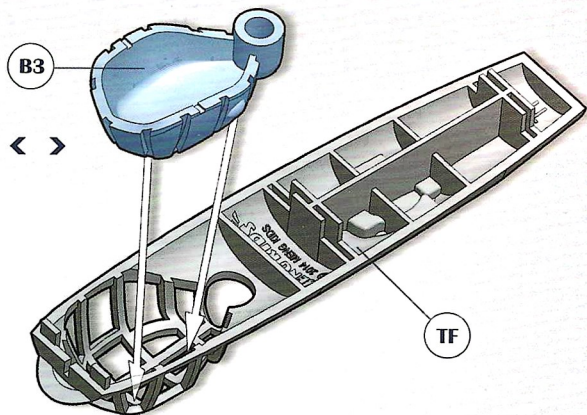

# 4

## 机身及机翼组装 FUSELAGE AND WING ASSEMBLY

x 4

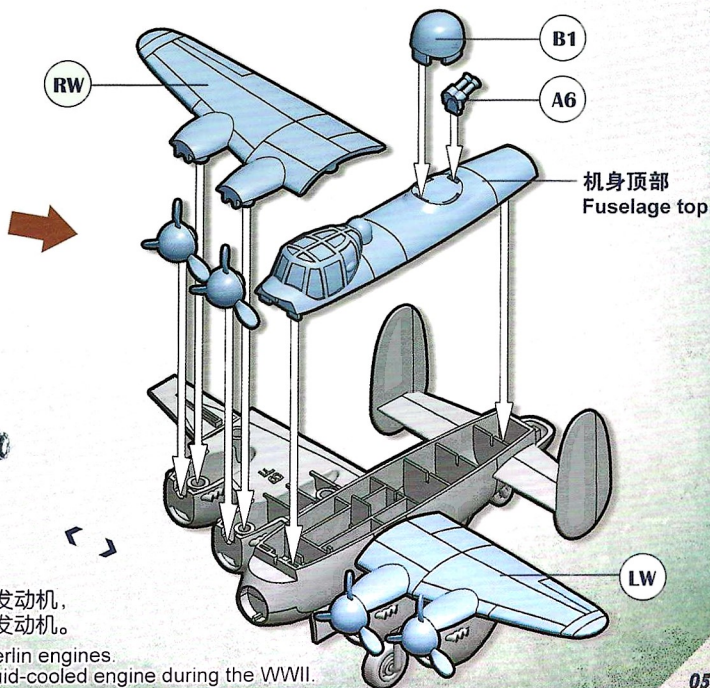
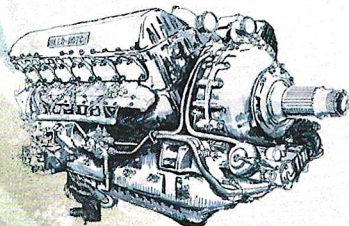
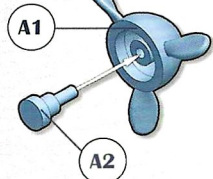

“兰开斯特”装备四台“灰背隼”发动机，这款发动机是二战中最著名的液冷发动机。

The Lancaster was fitted with four Merlin engines. The engine was the most famous liquid-cooled engine during the WWII.

# 机枪组装 MACHINE GUN ASSEMBLY



机头炮塔  
Nose turret

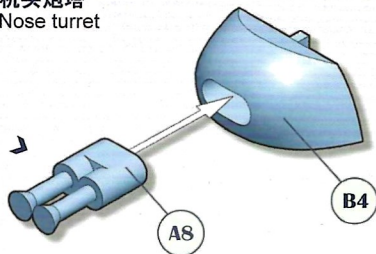

机尾炮塔  
Tail turret

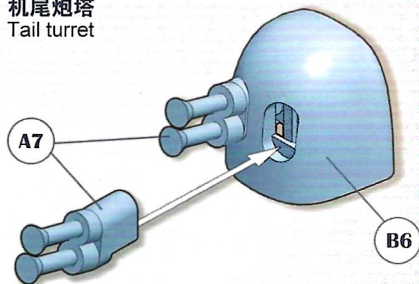

二战中英国轰炸机一直使用高射速的布朗宁7.7mm机枪作为自卫武器。

The defensive armament of WWII British bombers was the Browning 7.7mm machine gun. This machine gun had a high rate of fire.

# 炮塔组装 TURRET ASSEMBLY

“兰开斯特”的尾部炮塔装有四挺布朗宁机枪，火力凶猛。

The tail turret was equipped with four powerful Browning machine guns.

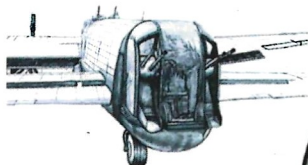

机尾炮塔  
Tail turret

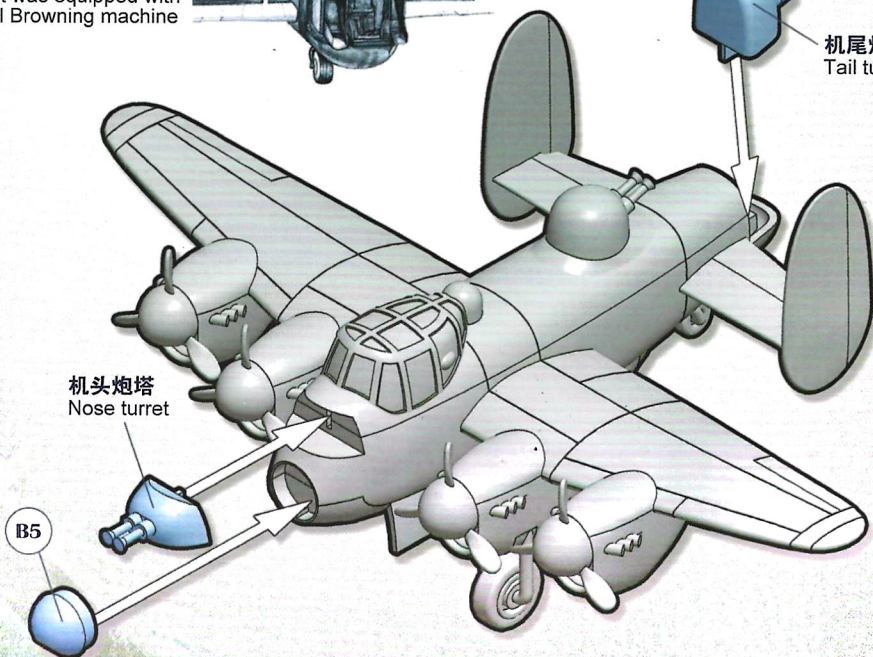

机头炮塔  
Nose turret

B5

# 涂装指示 PAINTING

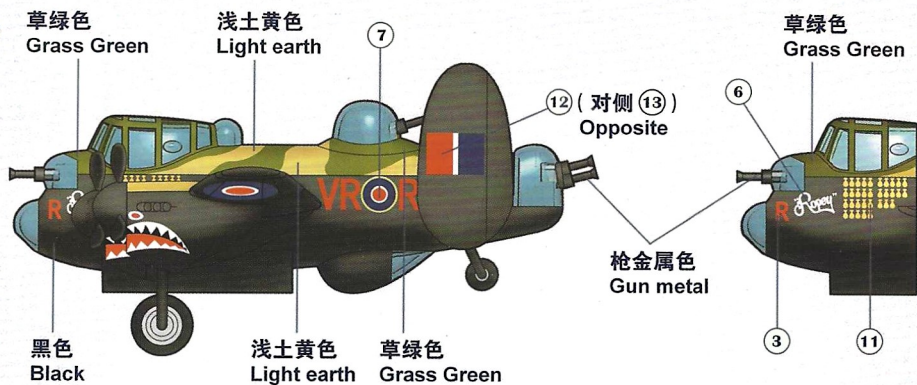

1. 可参照图示的色彩使用涂料进行涂装，以获得更精美的视觉效果。
2. 涂装时需要使用塑料模型专用喷涂工具、毛笔或塑料模型专用马克笔。
3. 在涂装时请遵从涂料及涂装工具的使用说明。
4. 本产品不含涂料及涂装工具。

1. You can paint the model with the suggested colors to achieve better visual effect.
2. You need paint spraying tools, paint brushes or special markers for plastic models.
3. Please follow the instructions of paints and painting tools when you paint the model.
4. Paints and painting tools are not included in this product.

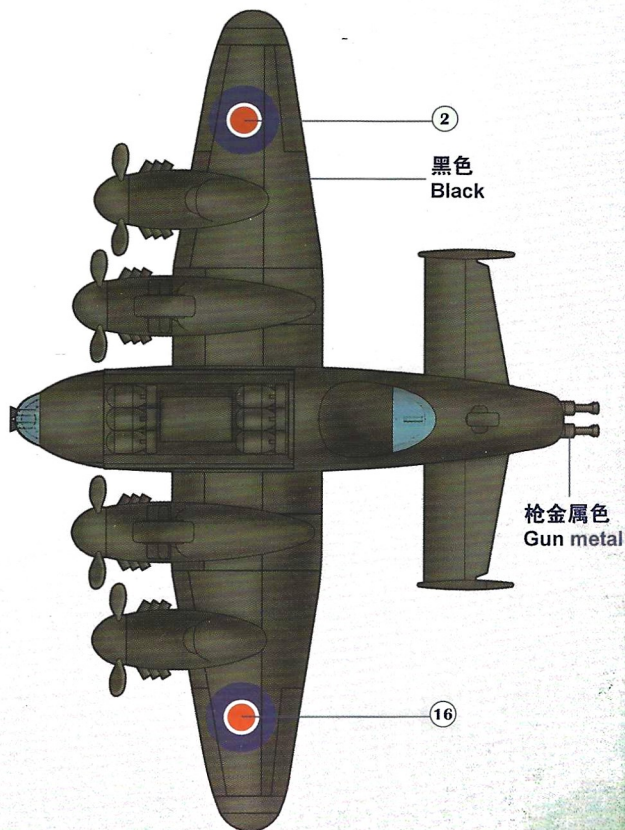

# 涂装指示 PAINTING

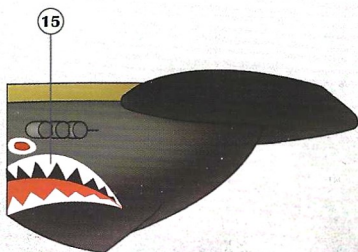
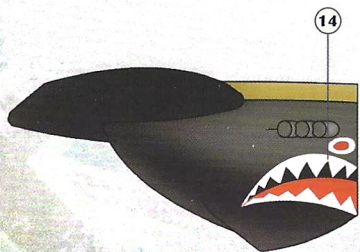
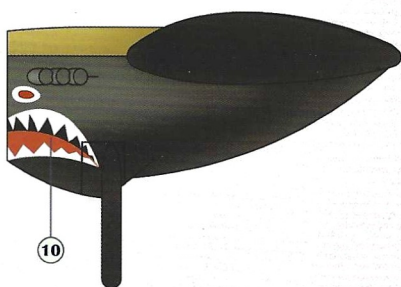
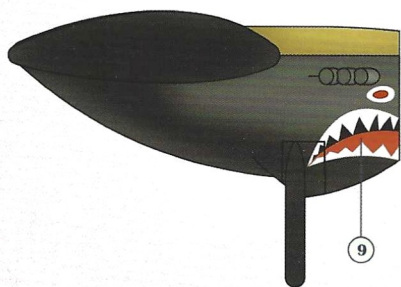
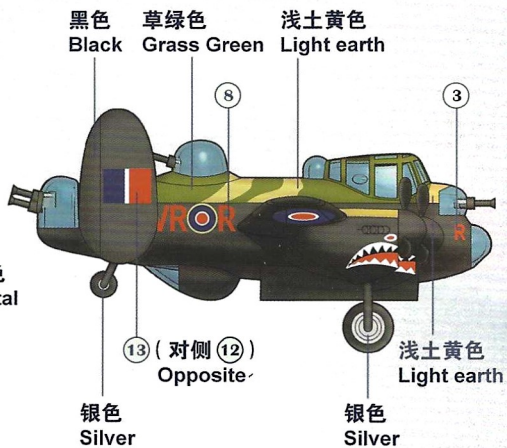
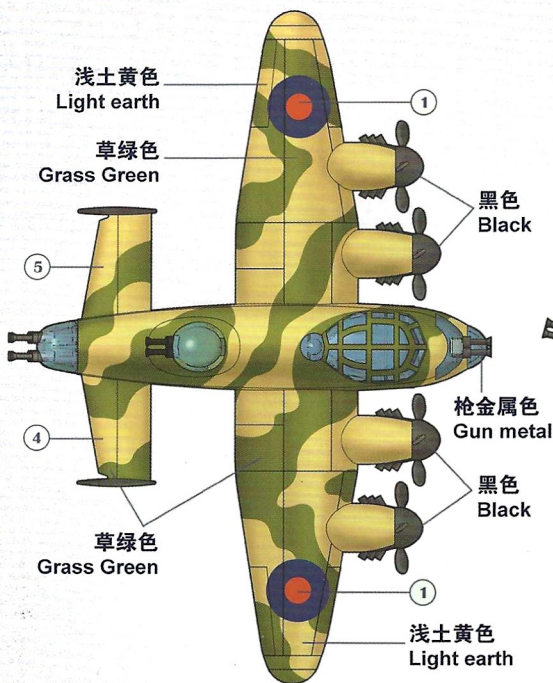



**售后**  
**AFTER-SALES SERVICE**

如果零件有缺失、破损等不良情况或者您对产品有任何建议，请用以下方式联系我们：

咨询热线：4001-870-090

邮箱：marketing2@meng-model.com

网址：www.meng-model.com

地址：广东省深圳市福田区彩田路3069号星河世纪大厦A栋3016

邮编：518000

If there are parts missing or broken, or if you have any suggestions, please contact us:

Hotline: +86 4001-870-090

E-mail: marketing1@meng-model.com

Website: www.meng-model.com

Address: Rm. 3016, Blk. A, Galaxy Century Bldg., No. 3069 Caitian Rd., Futian Dist.,  
Shenzhen, Guangdong, China

Zip code: 518000





**MENG KIDS** 

## “兰开斯特”的诞生

20世纪30年代，英国研制了一款轰炸机，叫“曼彻斯特”。它因为搭载了2台不靠谱的“秃鹰”发动机，经常飞不远，还总出故障。英军对它非常不满。幸运的是，二战爆发后，聪明的英国人给它更换了4台“灰背隼”发动机，不仅性能优异而且动力输出稳定，还获得了4073千米远的航程。英军向来有用地名来命名轰炸机的传统，于是，英国历史名城“兰开斯特”就成了它的名字。

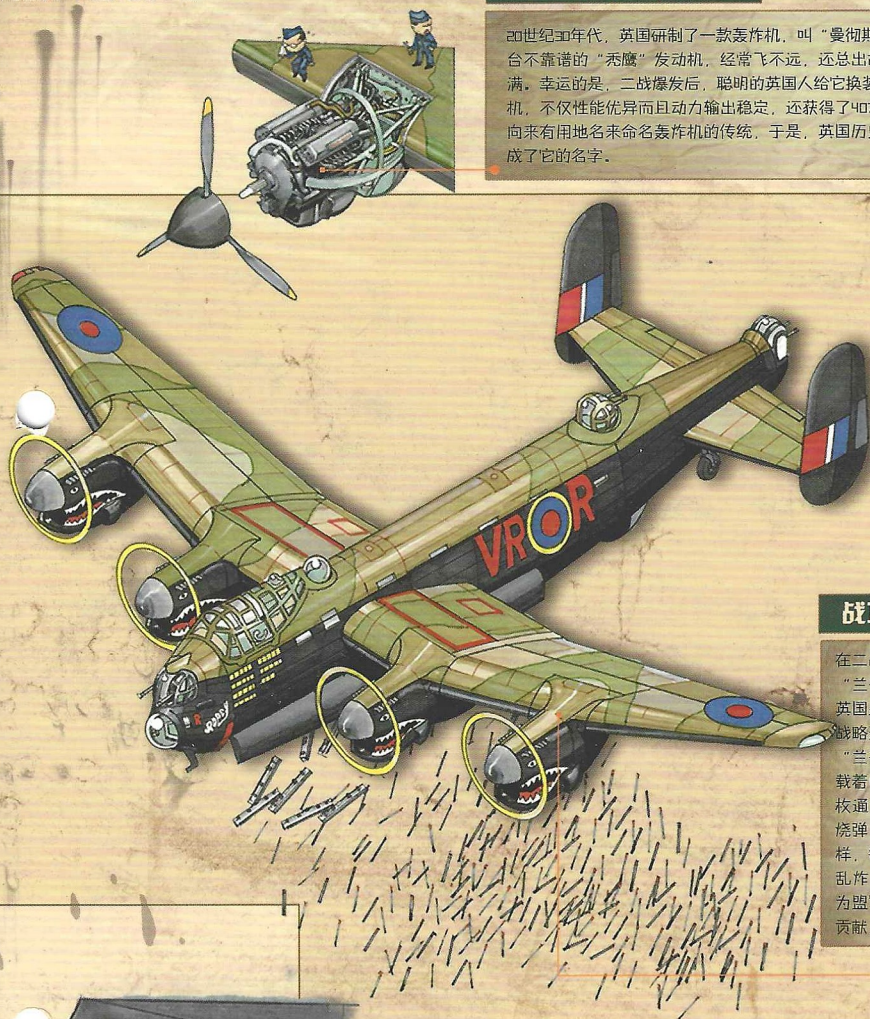

## 战功彪炳

在二战期间，性能优异的“兰开斯特”轰炸机，是英国皇家空军对德国进行战略轰炸的主力。当时的“兰开斯特”，通常会挂载着1枚巨大的爆破弹、6枚通用炸弹或100多枚燃烧弹，像勤劳的小蜜蜂一样，每天都飞往德国狂轰乱炸。3年的狂轰乱炸，为盟军的胜利做出了巨大贡献。

## 强大的雷达

二战时，“兰开斯特”跟很多英国轰炸机一样，有很强的电子作战能力，因为它机身庞大、飞行稳定，所以成为了世界上第一款强大的空地搜索雷达“硫化氢”（H2S）的主人。搭载了“硫化氢”（H2S）的“兰开斯特”，无论是复杂的天气还是夜间，都可以袭击1000千米以外的目标。

## 大弹舱和小炸弹

“兰开斯特”轰炸机有一个10.06米长的巨大弹舱，比中小学校的教室还长，可以装载各种各样的炸弹。当要攻击大面积的目标时，“兰开斯特”就会装载很多破坏力很大的集束炸弹。这种炸弹，是把小炸弹插在一起再装在一个弹箱里，就像是肚子里有很多小宝宝的妈妈，因此，它们还有个有趣的别名，叫“子母弹”。

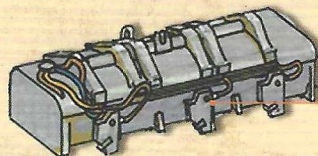

## 优秀的测试平台

“兰开斯特”庞大的机身、强大的挂载能力、4个发动机和很高的安全性，让它不只是一架强大的轰炸机，还是一个难得的测试飞机设备的平台。测试员把各种需要试验的飞机设备装在它身上，它就会冲向蓝天，在飞行中完成对飞机设备的测试。无论是把活塞发动机装在机头上，还是在机身上垂直安装攻击机机翼，这些高难度的动作它都能轻松完成。

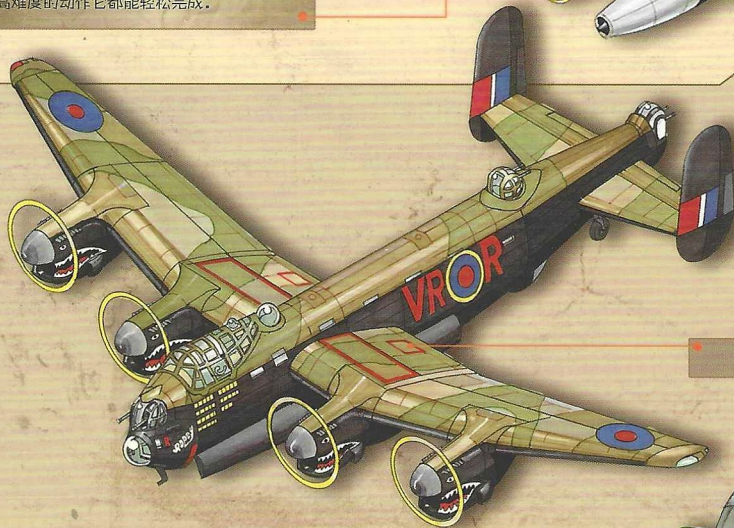
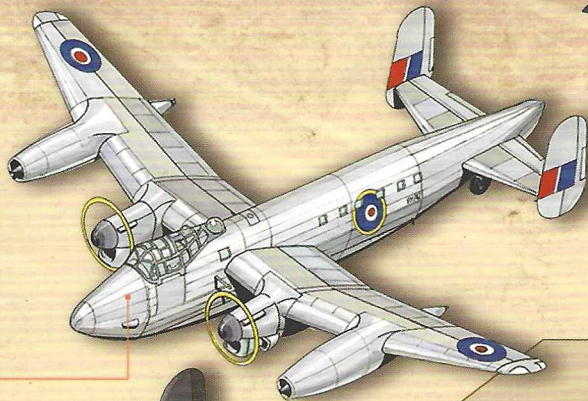

“兰开斯特”轰炸机

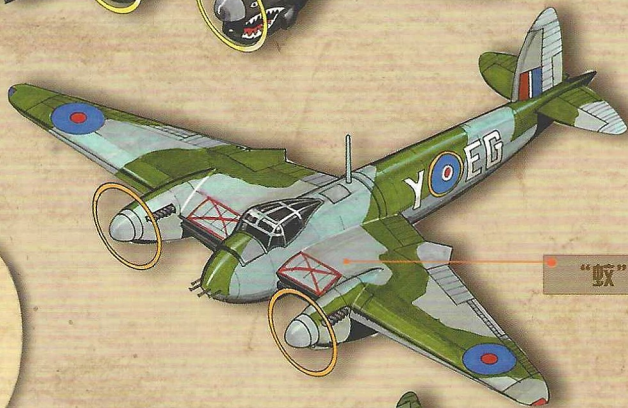

“蚊”式高速轰炸机

## 功成名就

“兰开斯特”轰炸机从1941年开始服役于英国，它努力工作了50年，直到1991年才退休。

“兰开斯特”的一生，打了无数的胜仗，为英军立下了很多战功，它与英国“喷火”式战斗机、“蚊”式高速轰炸机一起被称为英伦三杰，是英国先进航空技术的杰出代表。

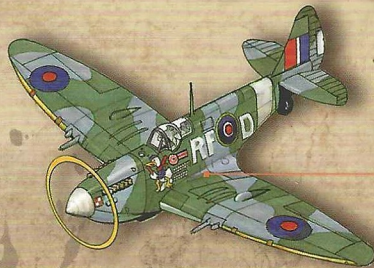

“喷火”式战斗机

