

1/72 scale

ITEM NO.:01675

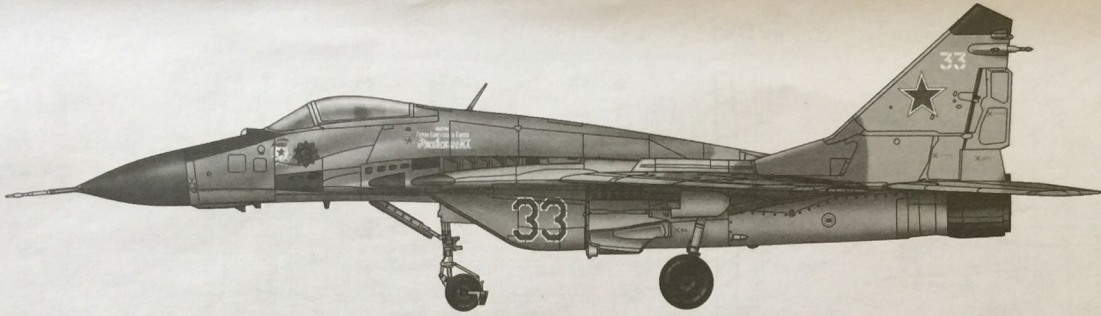

# MIG-29C Fulcrum (Izdeliye 9.13)

## MIG-29C“支点”战斗机(9.13批次)

### READ BEFORE ASSEMBLY:

- This kit is not recommended for inexperienced modelers or for children under 14 years of age
- Study and understand these instructions thoroughly before beginning assembly
- When needed, remove photo-etch parts carefully using a modeling knife or photo etch sprue cutter, being careful not to damage or lose small parts.
- Take extra care in handling photo etch parts in order to avoid injury
- Apply instant cement sparingly to photo etch parts where instructed

- Tools recommended(not included in kit):Plastic and instant cements,sprue cutters,long nose pliers,,modeling knife, small files, tweezers, pin vise & scissors. Soft cloth and sandpaper will also assist in construction
- Glue and paint are not included in the kit. Use plastic cement and hobby paints only. Color guide for purchasing paint is included in the kit.
- Keep out of reach of small children. They must not be allowed to ingest small parts or handle plastic bags in any way.

### 装配之前仔细阅读

- 小心用模型锉刀锉平所有零件表面的注射浇口。
- 小心用刀片切下蚀刻片零件，不要遗失小零件。
- 用强力快干胶水粘合蚀刻片零件和金属轴。过量的快干胶水使用可能导致可动零件会粘住，小心涂胶。
- 取蚀刻片时应特别注意安全，防止利边划伤手指。
- 某些零件表面需贴水上贴纸，请选择在装配的同时进行。
- 推荐模型工具(自备)：胶水，水口剪刀，长咀钳，刀片，锉刀，镊子钳，钻，剪刀，瞬间快干胶。
- 软布同砂纸同时也应该是必备工具。
- 请使用塑料胶水和油漆，模型内不含。
- 谨防小孩吸吮塑料零件，或者将塑料袋套在头上，制作时应将套材远离小孩接触。
- 本产品不适合14岁以下没有经验的模型爱好者。

### 水贴纸的使用:

1. 从水贴上剪下印花;
2. 将印花放入温水中浸10秒，然后放在干净布上;
3. 拿着印花纸板将印花移到模型上;
4. 手指蘸水将印花移到适当的位置;
5. 用软布轻压印花直至水干，汽泡消失。

### DECAL APPLICATION:

1. Cut decals from sheet as needed
2. Dip the decal in warm water for about 10 seconds and then place on soft clean cloth.
3. Hold the decal backing sheet edge and gently slide the decal onto the model in its proper position.
4. While still wet, decal can be adjusted for better fit on model by dampening it gently with your finger.
5. When placed in the proper position, gently press decal down with a soft cloth until excess water and air bubbles are gone.
6. Allow decal to dry completely before handling model

			
使用强力胶 Cyanoacrylate glue	配重 Weight	钻孔 Make hole	切除 Cut / Remove
			
贴纸 Decal	锉平 File / Sand	选择 Option	不涂胶水 No cement
			
			弯曲 Bend

01675

部品图  
Parts

《上机身》  
Top fuselage

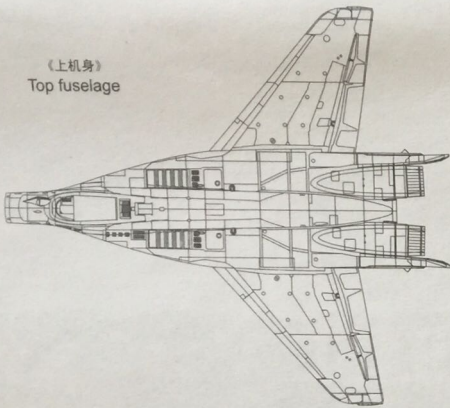

《下机身》  
Lower fuselage

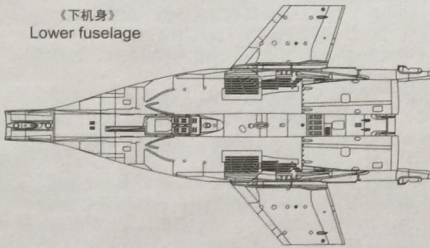

DX1

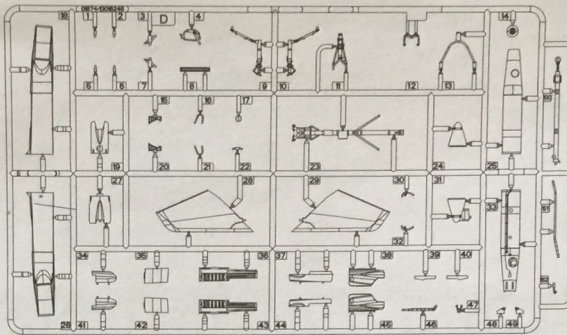

HX1

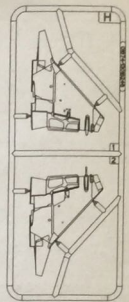

JX2

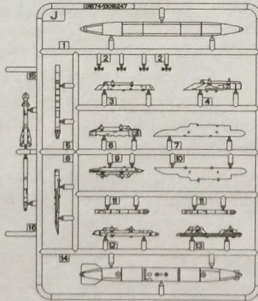

KX2

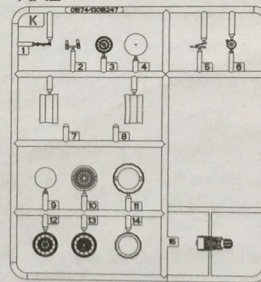

FX1

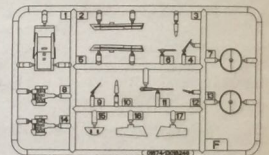

Q1X1

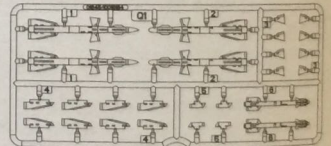

RX1

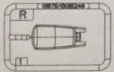

PX1



MX1

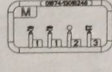

《水贴纸》A  
Decal A



《水贴纸》B  
Decal B



不用的部件: F8 F9 F10 F13 J2 J3 J6 J7 J10  
Unused parts

1

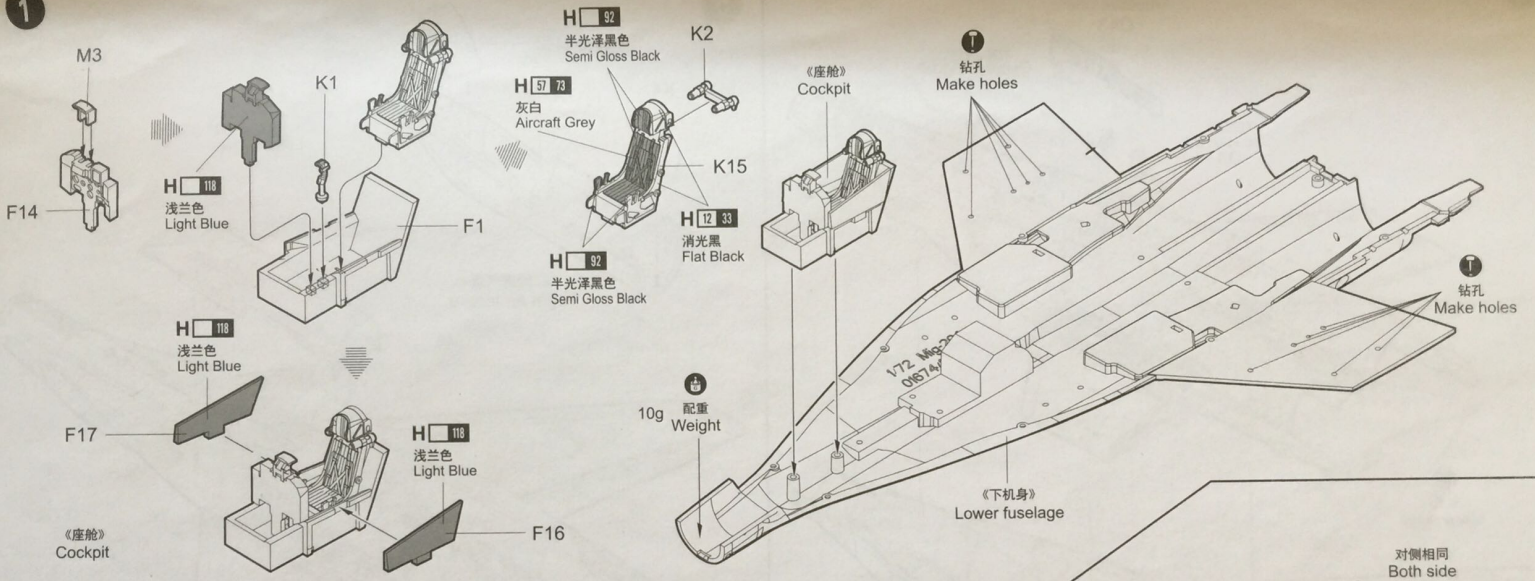

2

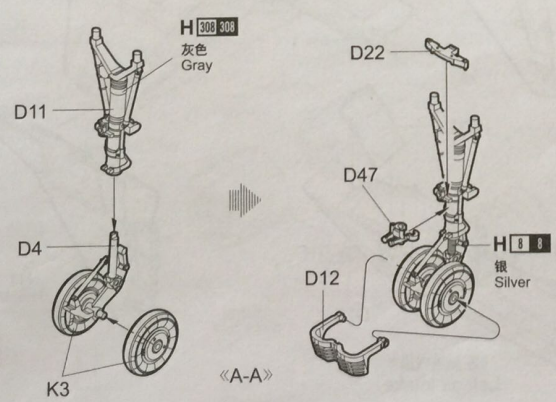

3

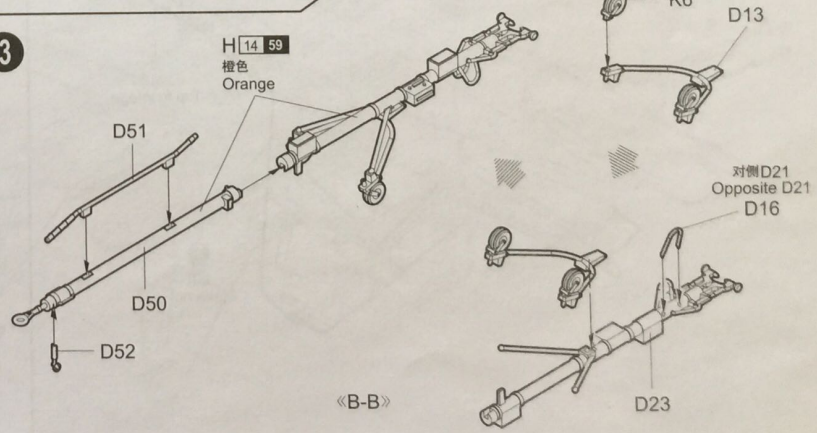

4

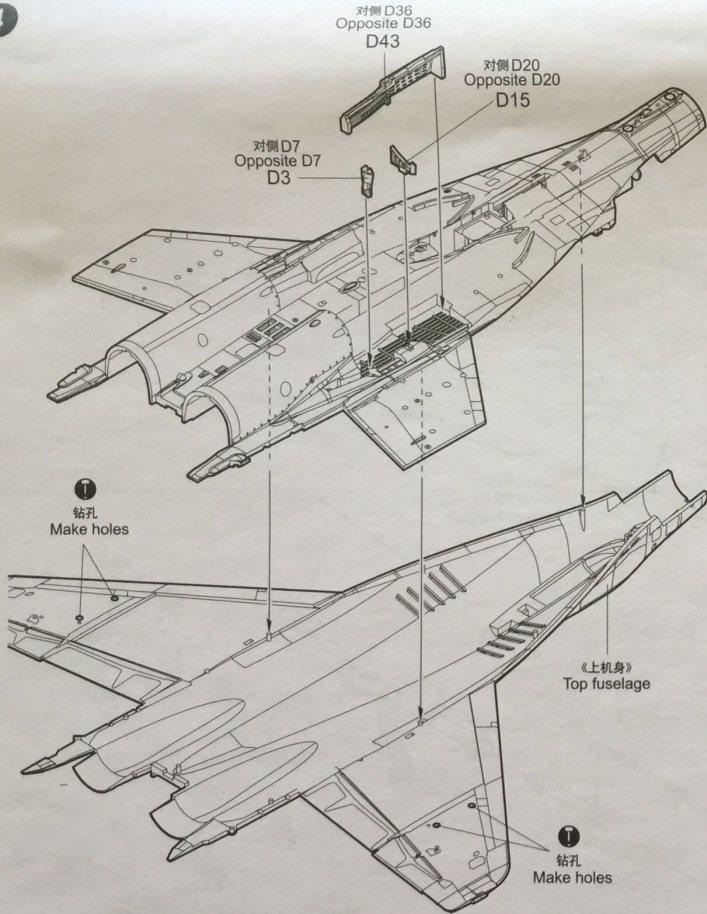

5

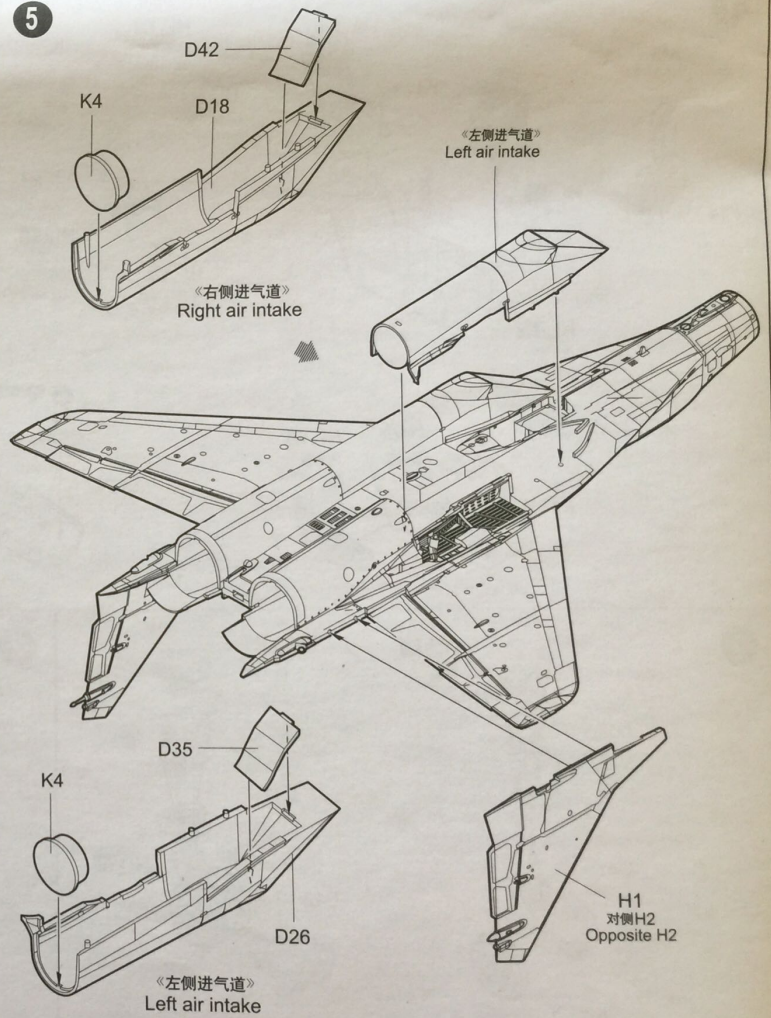

6

H 308  
银  
Silver

M1

H 309 308  
灰色  
Gray

D38

D19

D20

D17

F7

F11

D45

M1

对侧相同  
Both side

对侧 D37  
Opposite D37  
D44

对侧 D34  
Opposite D34  
D41

对侧 D1  
Opposite D1  
D2

对侧 D5  
Opposite D5  
D6

F6

7

H 317 317  
灰色  
Dark Gull Grey

K11

K14

K7+K8

K10

H 76 61  
烧铁色  
Burned Iron

制作2组  
Make two

K9

对侧相同  
Both side

K5  
对侧相同  
Both side

8

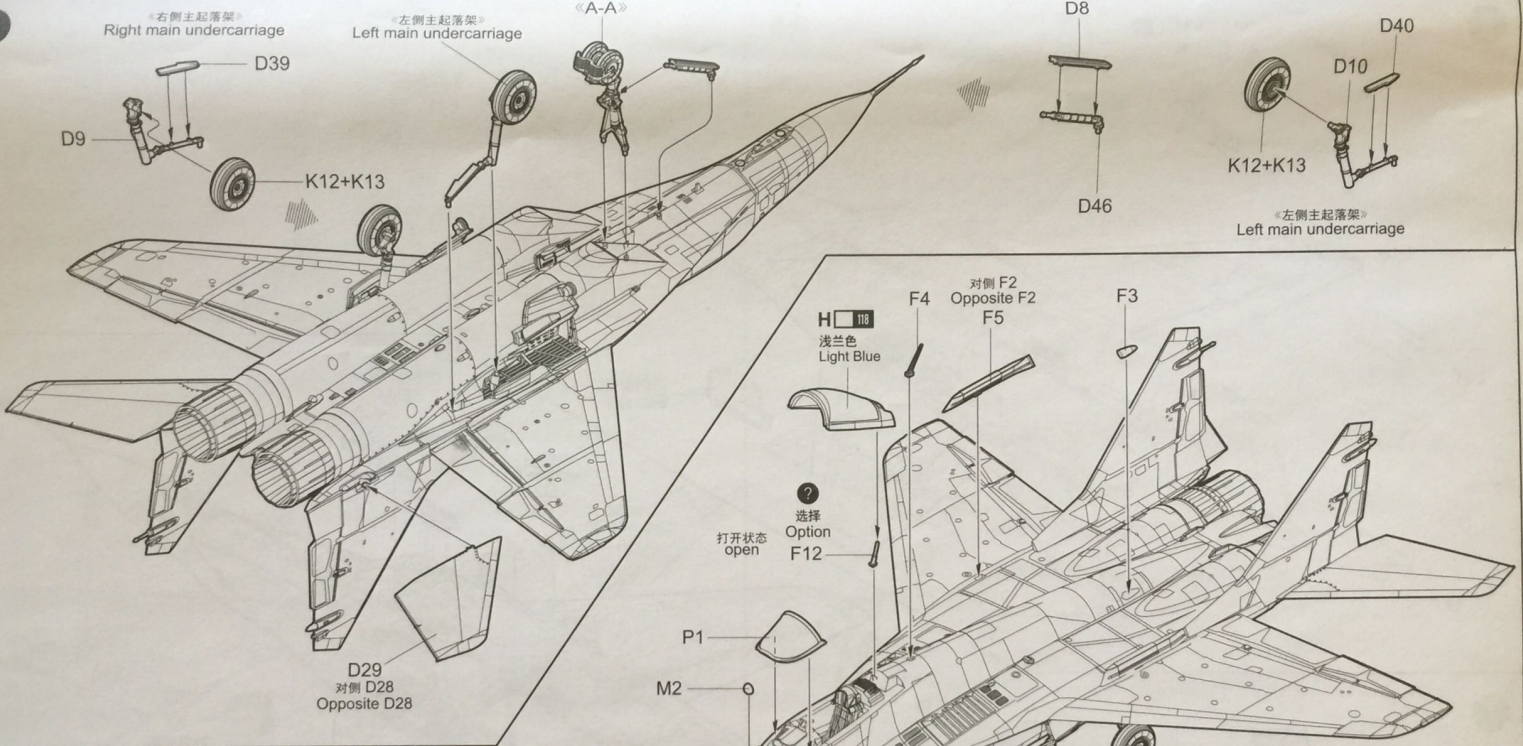

9

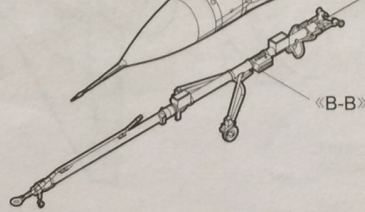
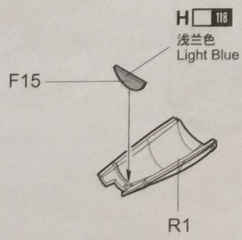

01675

6

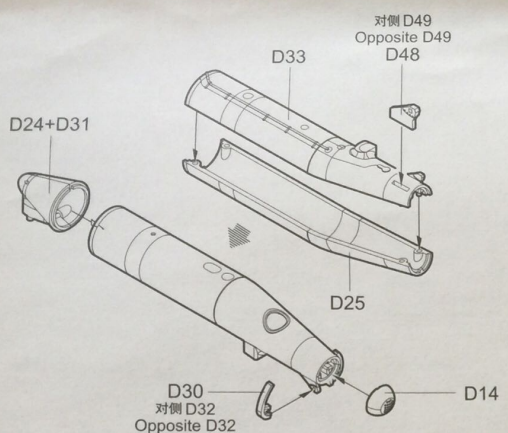

PTB-1500

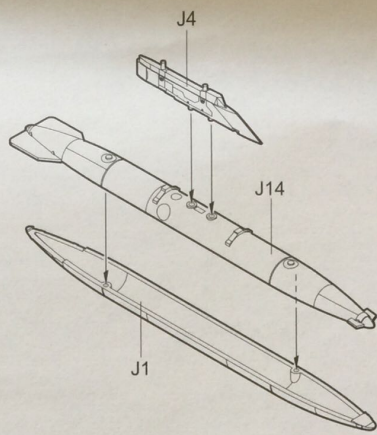

PTB-1500  
制作2组  
Make two

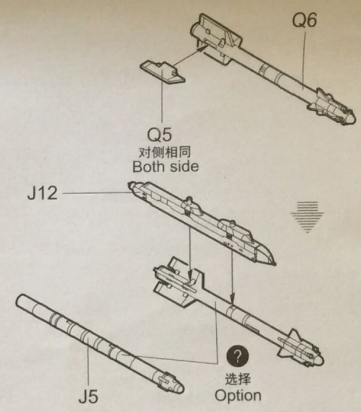

R-73E  
制作2组  
Make two

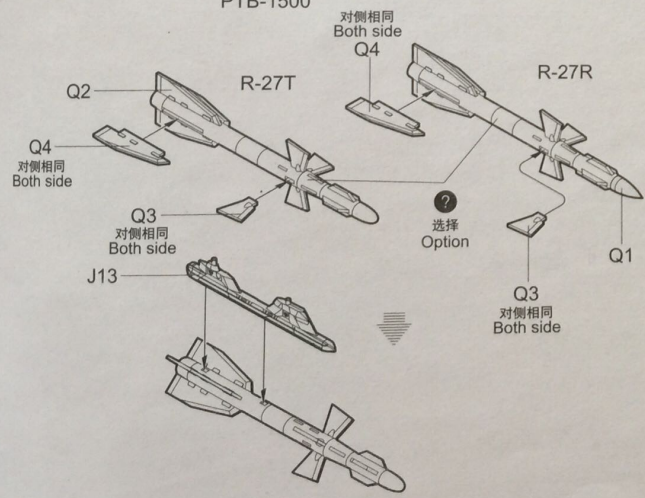

R-27T/R-27R  
制作2组  
Make two

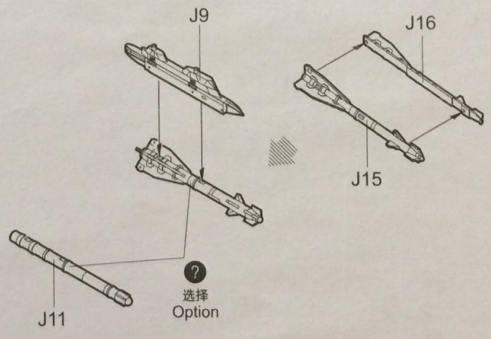

R-60  
制作2组  
Make two

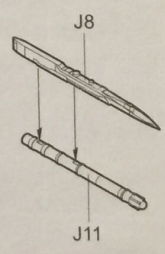

R-60  
制作2组  
Make two

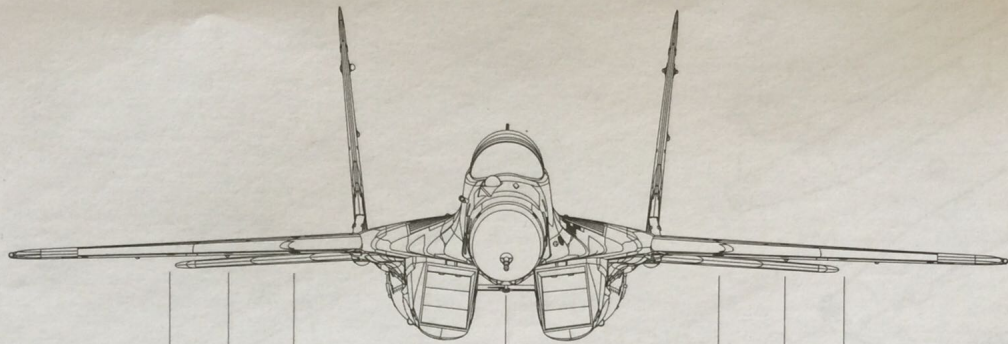

Sta.No.	1	2	3	4	5	6	7
Missile/Tank							
PTB-1500				●			
PTB-1150			●		●		
R-27T			●		●		
R-27R			●		●		
R-60	●	●	●		●	●	●
R-73E	●	●	●		●	●	●

# 涂装同标贴指示

## Painting & Marking guide

**A** Russian Air Force, 5th PVO Division,  
28th GvIAP, 2nd Squadron, Mig-29C  
(Izdeliye 9.13), '33 Blue' N.Kh.  
Rzhavskiy(c/n 2960728139).

PAINT REFERENCE COLOUR					
Color	Mr.Hobby	Vallejo	Model Master	Tamiya	Humbrol
浅松叶色 Light Green	H 319 319	-	1713	-	117
灰色 Gray	H 308 308	893	1710	XF58	116
胎黑色 Tire Black	H 77 137	-	-	-	-
锈棕色 Burnt Iron	H 76 61	863	1795	X10	53
银色 Silver	H 8 8	997	1546	X11	11
红色 Red	H 3 3	908	1503	X7	19
浅兰色 Light Blue	H 118	-	-	-	175

PAINT REFERENCE COLOUR					
Color	Mr.Hobby	Vallejo	Model Master	Tamiya	Humbrol
哑光黑色 Flat Black	H 12 33	950	1749	XF1	33
灰色 Metallic Gunmetal Grey	H 305 305	868	1723	XF58	125
透明红 Clear Red	H 90 47	934	-	X27	-
草绿色 Crew Green	H 94	936	-	X25	-
深松叶色 Dark Green	H 320 320	895	-	XF26	30
灰色 Light Gull	H 325 325	-	1730	XF55	129
米色1号	H 92	950	-	X18	-

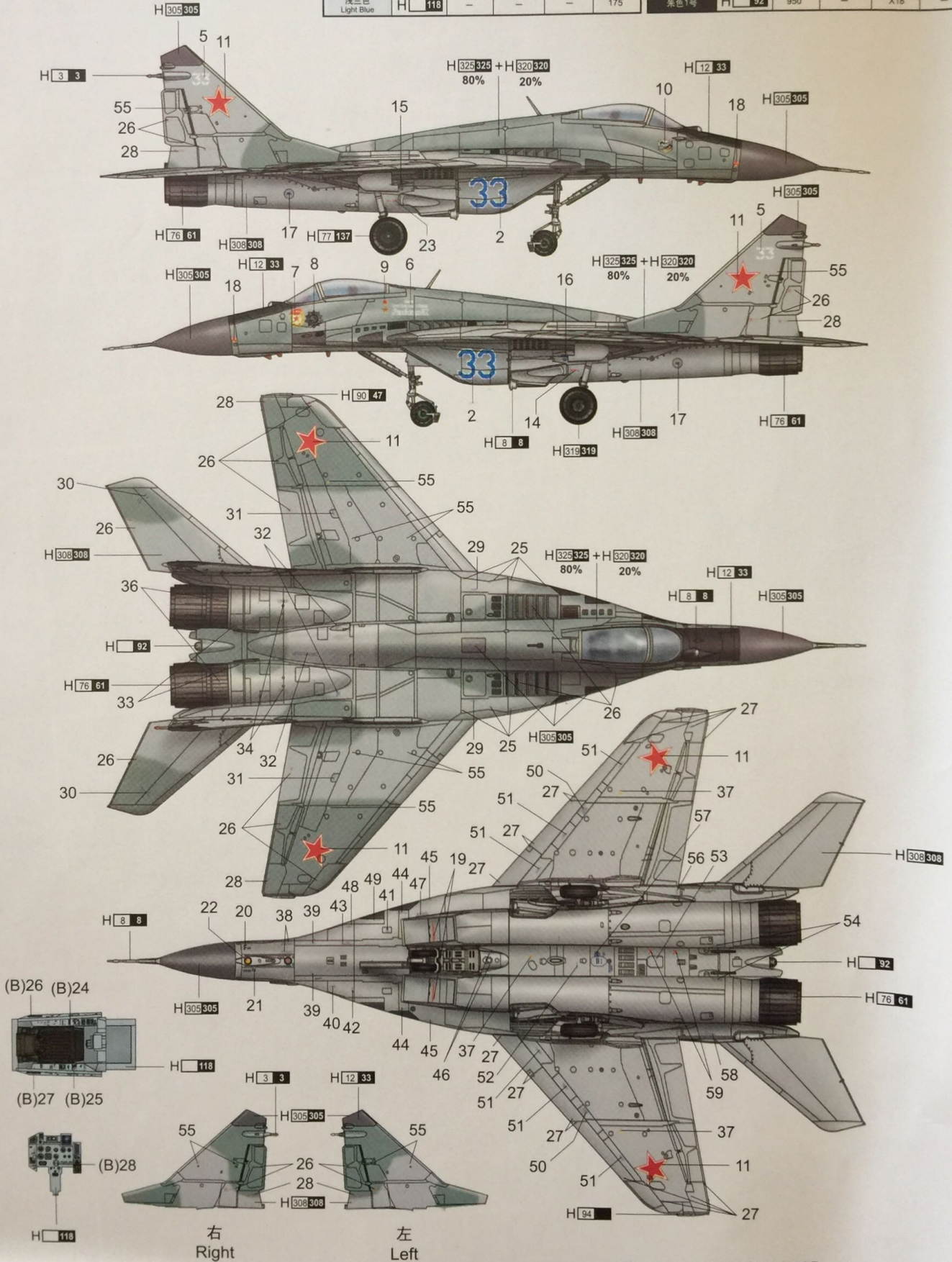

H [ ] AQUEOUS HOBBY COLOR

Mr. COLOR

涂装同标贴指示  
Painting & Marking guide

**B** Ukraine Air Force, Gostomoel airport,  
Mig-29C(Izdelye 9.13), '44 White'  
(c/n 2960731230, f/n 5329?).

PAINT REFERENCE COLOUR

Color	Mr.Hobby	Vallejo	Model Master	Tamiya	Humbrol
浅松叶色 Light Green	H 319 319	-	1713	-	117
灰色 Gray	H 308 308	893	1710	XF58	116
胎黑色 Tire Black	H 77 137	-	-	-	-
烧铁色 Burnt Iron	H 76 61	863	1795	X10	53
银色 Silver	H 8 8	997	1546	X11	11
红色 Red	H 3 3	908	1503	X7	19
浅兰色 Light Blue	H 118	-	-	-	175

PAINT REFERENCE COLOUR

Color	Mr.Hobby	Vallejo	Model Master	Tamiya	Humbrol
哑光黑色 Flat Black	H 12 33	950	1749	XF1	33
灰色 Medium Gunship Grey	H 305 305	868	1723	XF58	125
透明红 Clear Red	H 90 47	934	-	X27	-
透明绿 Clear Green	H 94	936	-	X25	-
深松叶色 Dark Green	H 320 320	895	-	XF26	30
灰色 Light Gull	H 325 325	-	1730	XF55	129
朱色1号	H 92	950	-	X18	-

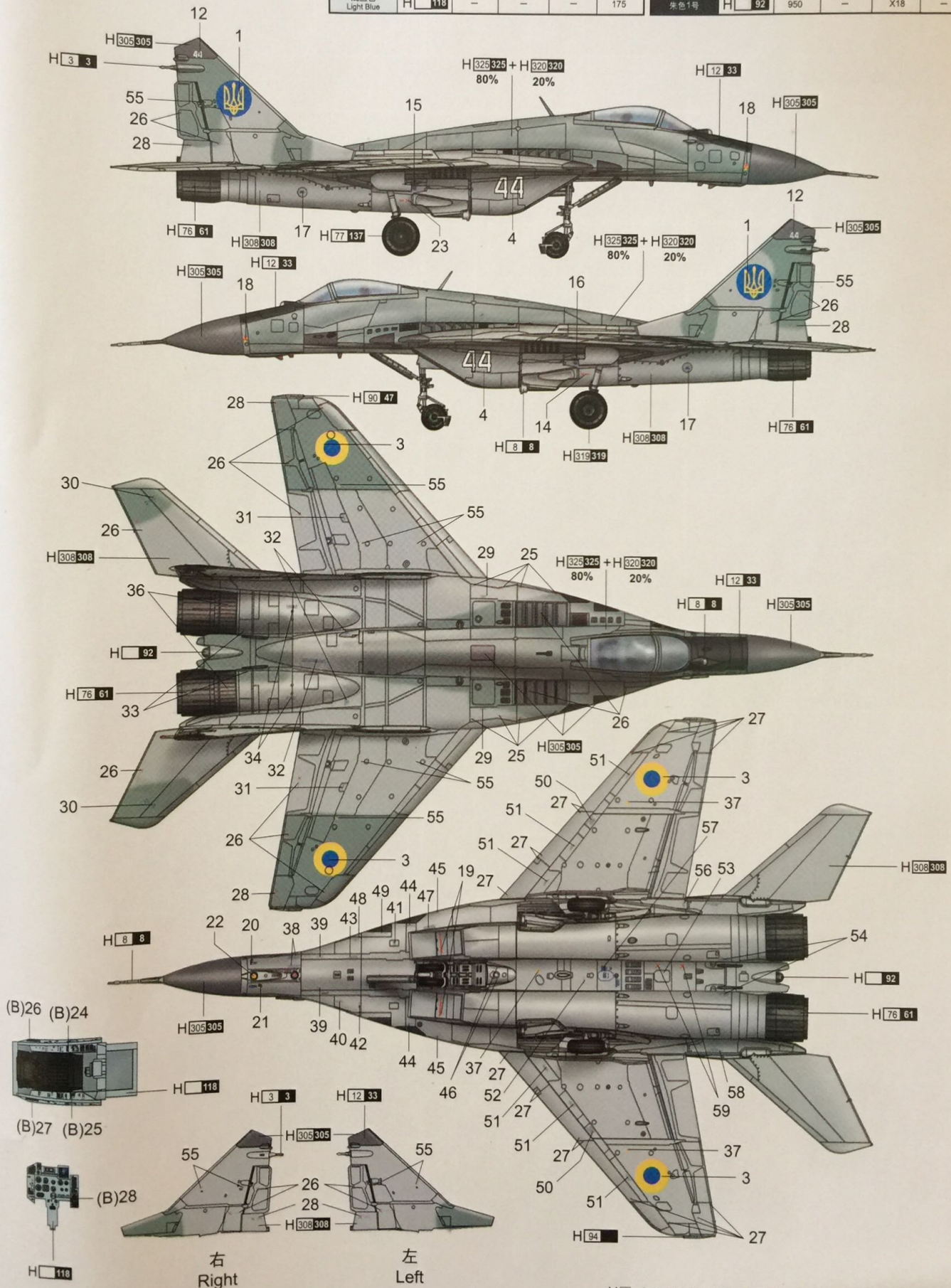

# 涂装同标贴指示 Painting & Marking guide

## PAINT REFERENCE COLOUR

Color	Mr.Hobby	Vallejo	Model Master	Tamiya	Humbrol	Color	Mr.Hobby	Vallejo	Model Master	Tamiya	Humbrol
白色 White	H 1 1	842	1745	XF2	22	烟灰色 Smoke Blue	H 96 101	—	—	—	—
灰色 Gray	H 308 308	990	1728	XF19	127	白色 White	H 316 316	991	1745	X2	22
						灰色 Medium Gray	H 306 306	—	1741	XF22	128

R-73E x2

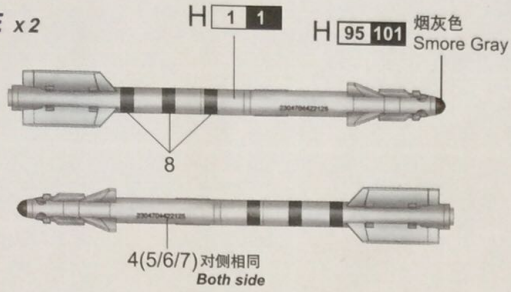

R-60 x2

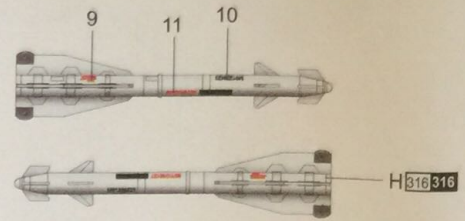

R-27R x2

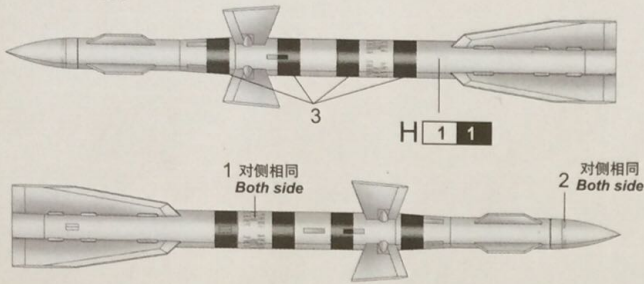

R-27T x2

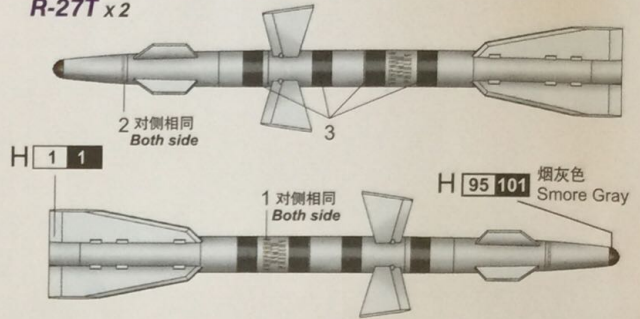

PTB-1500 x1

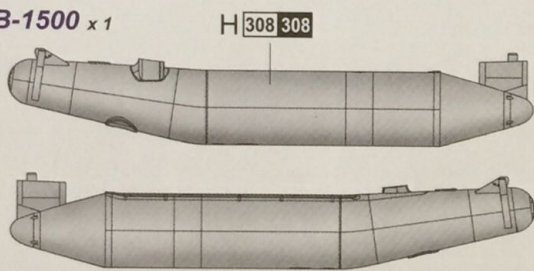

PTB-1150 x2

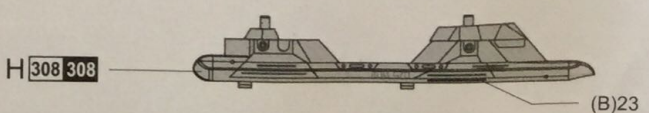
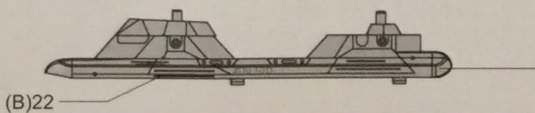
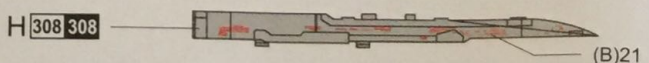
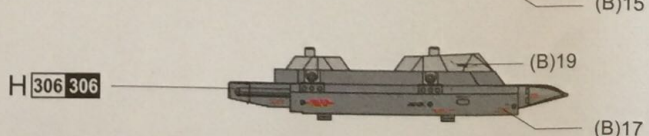
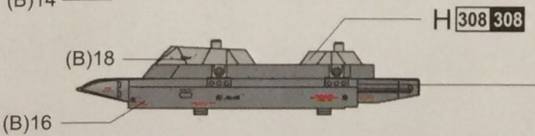
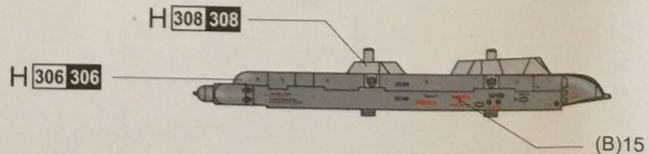
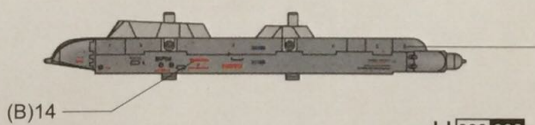
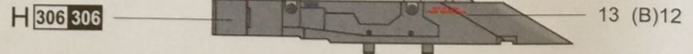
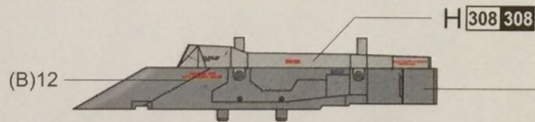
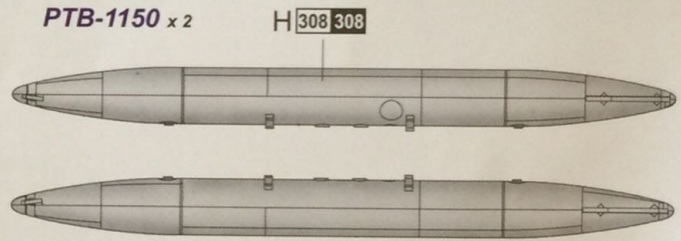

H X AQUEOUS HOBBY COLOUR

X MR.COLOUR