

USS BALTIMORE CA-68 1944

美国海军巴尔的摩号重巡洋舰 CA-68 1944年

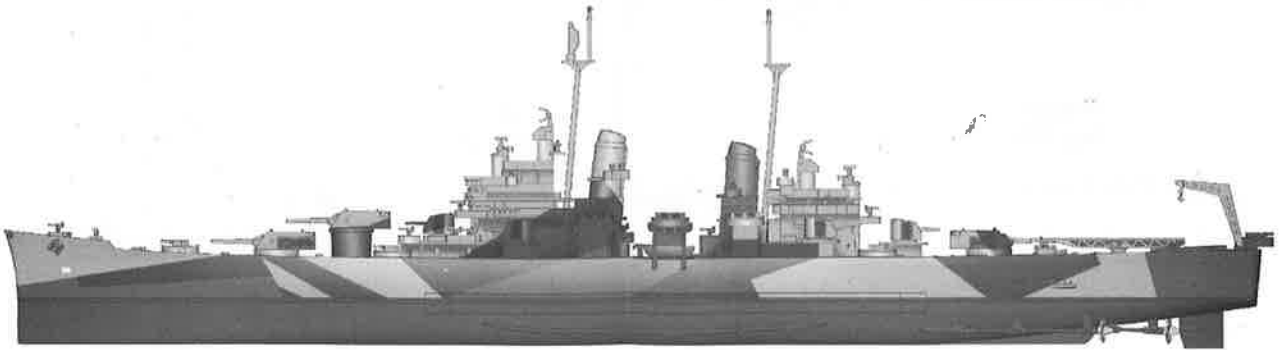

READ BEFORE ASSEMBLY

- Study and understand these instructions thoroughly before beginning assembly. Make sure all parts are included by comparing them to those shown on page 2 of these instructions.
- Remove parts from sprues as needed , and trim excess with a hobby knife. Be careful not to lose small parts.
- Remove photo-etch parts from sprue as needed using a hobby knife or photo etch cutter.
- Apply cement to photo etch parts as shown on instructions.
- Applying too much cement will restrict the operation of these movable parts. Apply cement carefully! Removed photo etch parts can have sharp edges. Take care when handling these to avoid injury.
- Apply decals to necessary parts prior to assembly.
- Additional tools recommended(not included):Sprue cutter, Long nose pliers, hobby knife, file, tweezers, pin vise, scissors, cement, sandpaper, soft cloth, glue and paint.
- Keep all parts out of reach of children, as they pose a choking hazard. Discard all unnecessary bags and sprues when model is completed to avoid accidental injury.

装配之前仔细阅读

- 小心用模型锉刀锉平所有零件表面的注射浇口。
- 小心用刀片切下蚀刻片零件，不要遗失小零件。
- 用强力快干胶水粘合蚀刻片零件和金属轴。过量的快干胶水使用可能导致可动零件会粘住，小心涂胶。
- 取蚀刻片时应特别注意安全，防止利刃划伤手指。
- 某些零件表面需贴上水贴纸，请选择在装配的同时进行。
- 推荐模型工具(自备)：胶水，水口剪刀，长咀钳，刀片，锉刀，镊子钳，钻，剪刀，瞬间快干胶。
- 软布同砂纸同时也应该是必备工具。
- 请使用塑料胶水和油漆，模型内不含。
- 谨防小孩吸吮塑料零件，或者将塑料袋套在头上，制作时应将套材远离小孩接触。



cyanoacrylate glue
使用强力胶



weight
配重



make hole
钻孔



cut / remove
切除



bend
弯曲



file / sand
锉平



option
选择



no cement
不涂胶水



decal
贴纸

水贴纸的使用:

1. 从水贴上剪下印花;
2. 将印花放入温水中浸10秒，然后放在干净布上。
3. 拿着印花纸板将印花移到模型上;
4. 手指蘸水将印花移到适当的位置;
5. 用软布轻压印花直至水干，气泡消失。

DECAL APPLICATION

1. Cut off decal from sheet.
2. Dip the decal in tepid water 40°C for about 10 sec. and place on a clean cloth.
3. Hold the backing sheet edge and slide decal onto the model.
4. Move decal into position by wetting decal with finger.
5. Press decal gently down with a soft cloth until excess water and air bubbles are gone.

部品图

Parts:

《前上船体》
Fore Upper Hull

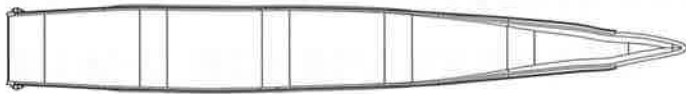

《下船体》
Lower Hull



《水线板》
Waterline plate



《前甲板》
Fore deck

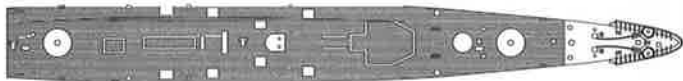

《后上船体》
Aft Upper Hull



《后甲板》
Aft deck

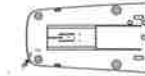

A

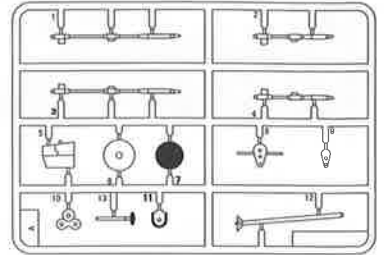

《座架》
Stand

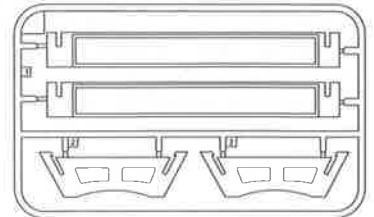

《铭牌》
Name plate

1:700 Scale US Navy CA-68 1944
USS BALTIMORE

C

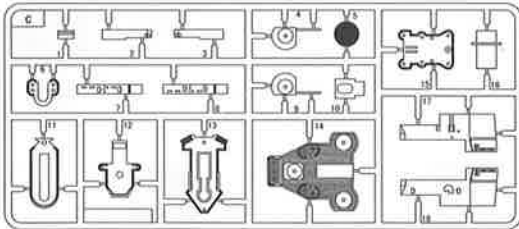

Gx2

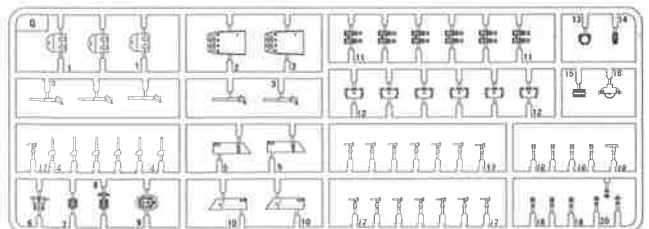

D

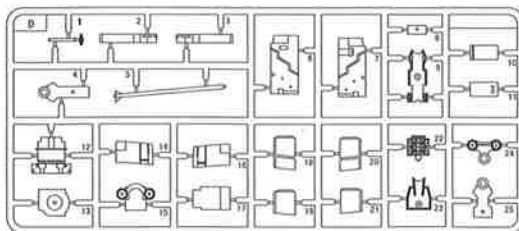

Hx2

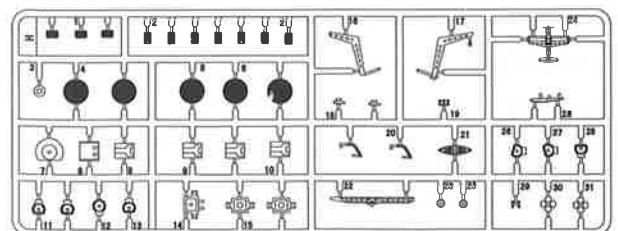

Decal



1 甲板上的组装
Assembly on the decks

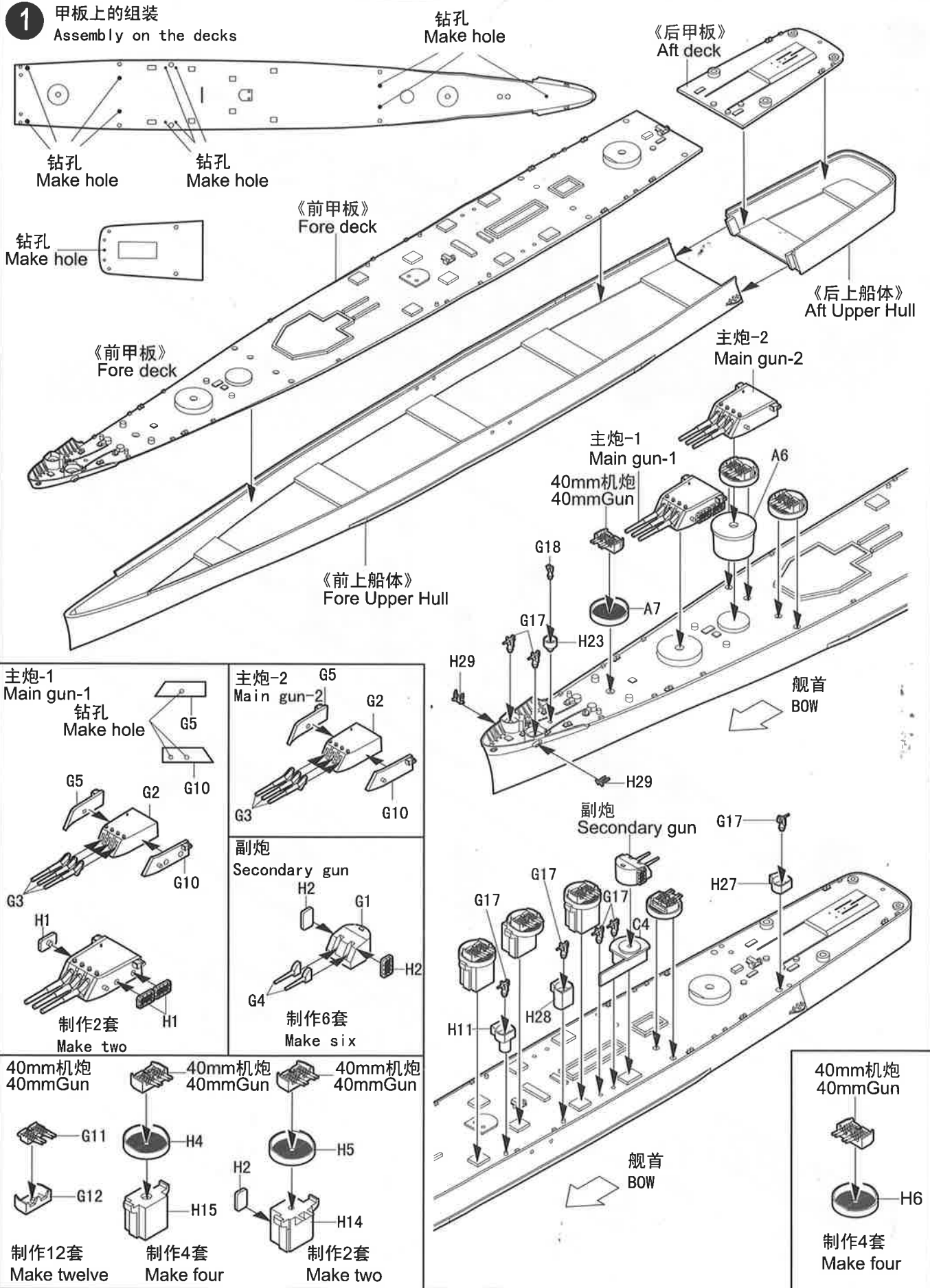

2 甲板上的组装
Assembly on the decks

起重机
CRANE

H17
H16

制作2套
Make two

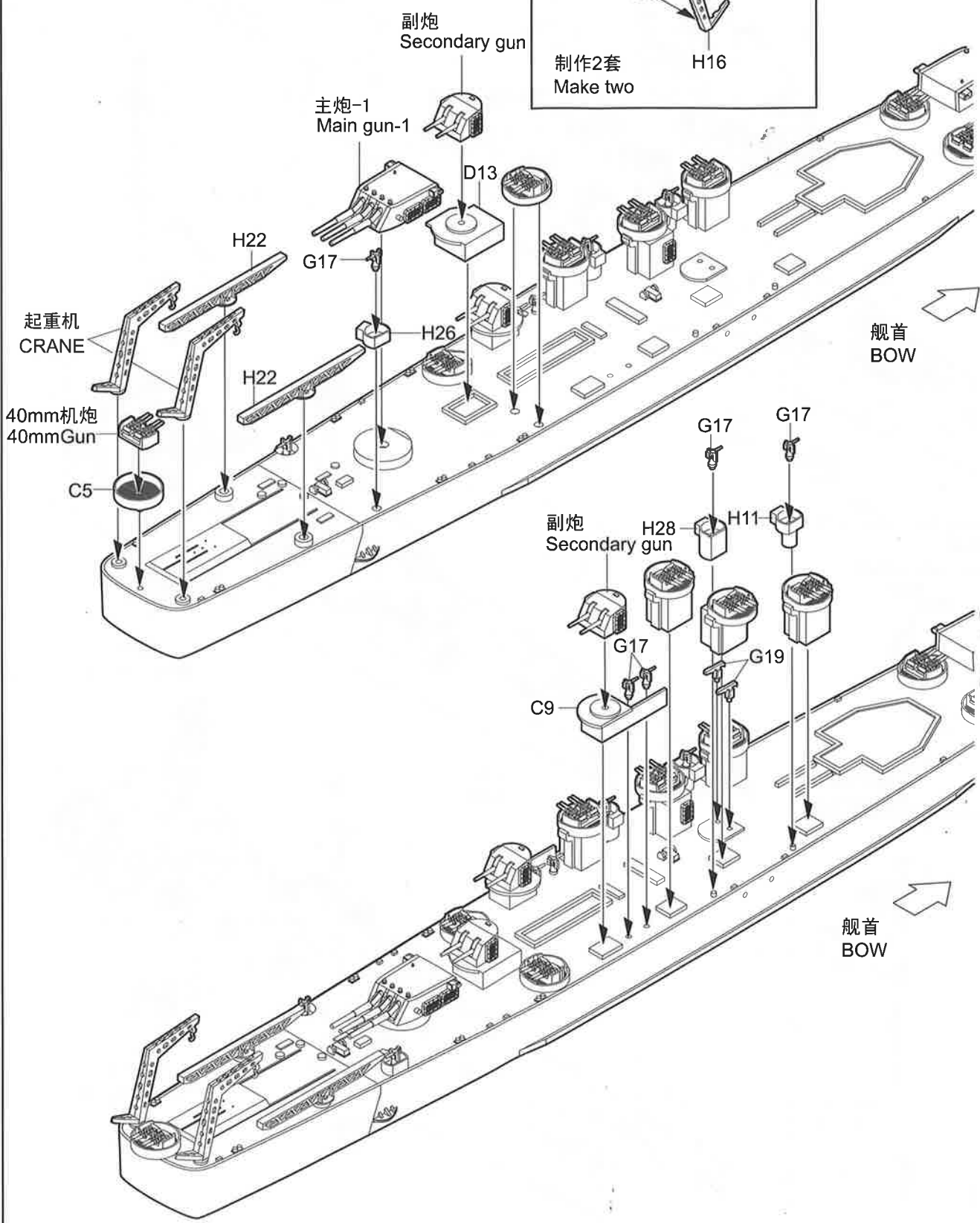

3

舰桥部分的组装
Assembly of island

MK38 指挥仪
MK38-Director



制作2套
Make two

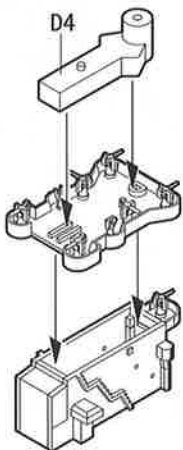
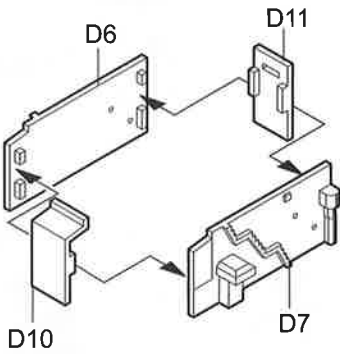
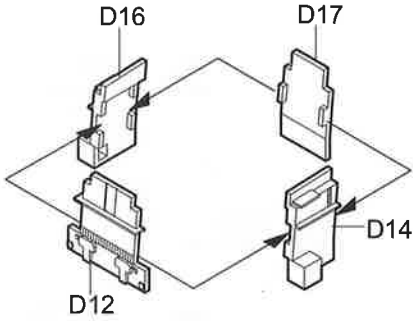

MK37 指挥仪
MK37-Director

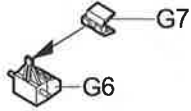

制作2套
Make two

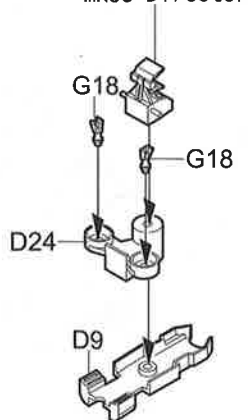

烟囱-1
Chimney-1

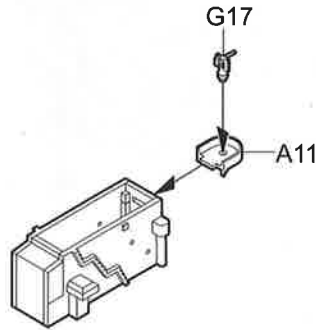
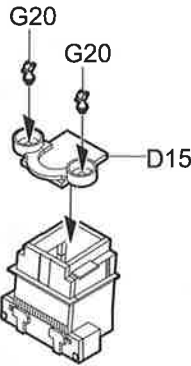
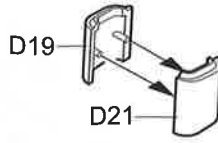

烟囱-1
Chimney-1

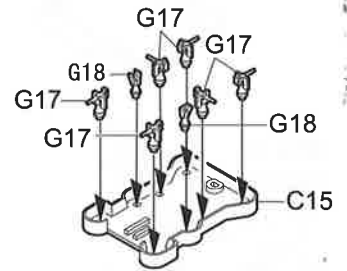
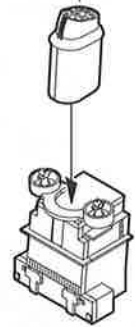

MK37 指挥仪
MK37-Director

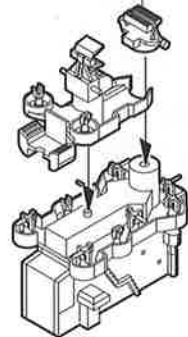

4 舰桥部分的组装

Assembly of island

副炮
Secondary gun

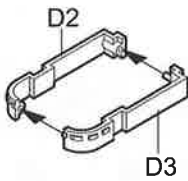
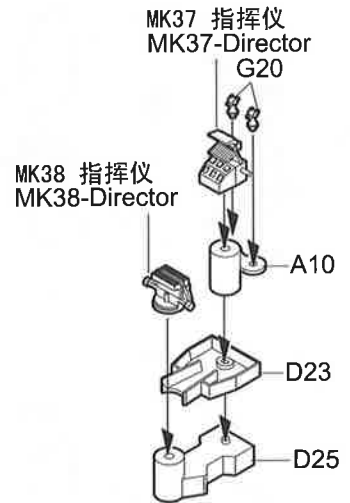
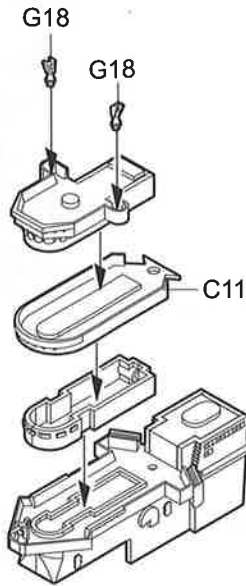
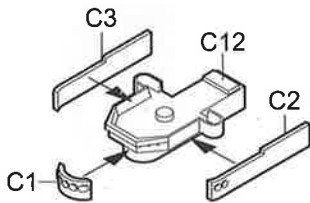
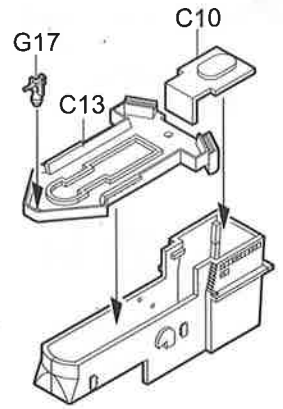
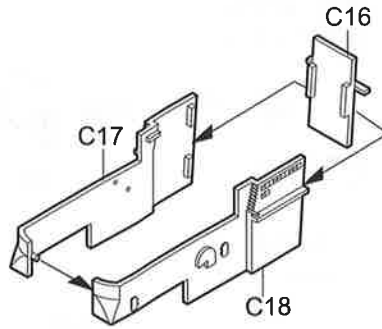
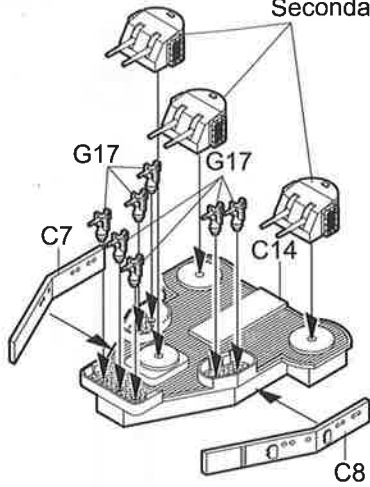

烟囱-2
Chimney-2

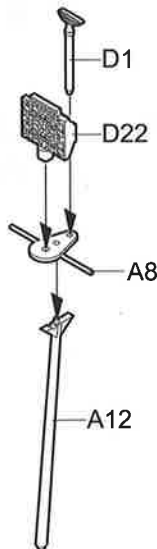
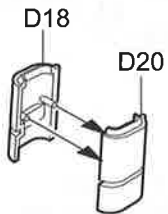

烟囱-2
Chimney-2

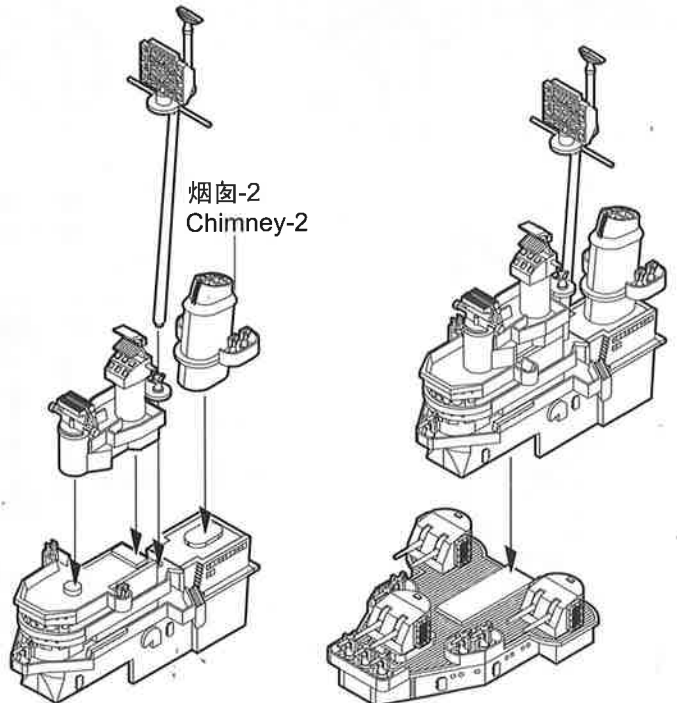
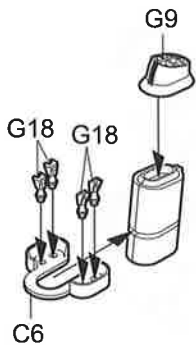

5

舰桥的组装
Assembly of island

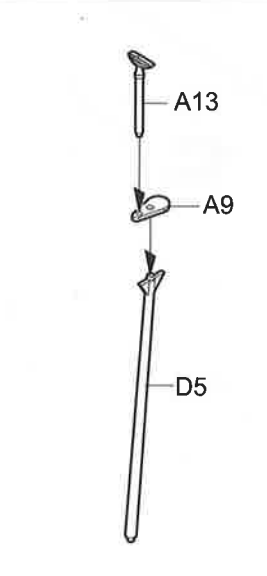
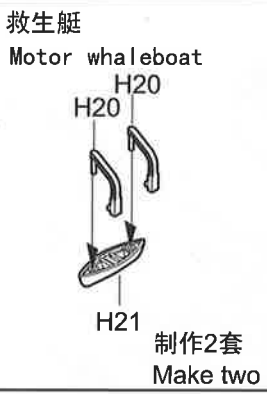
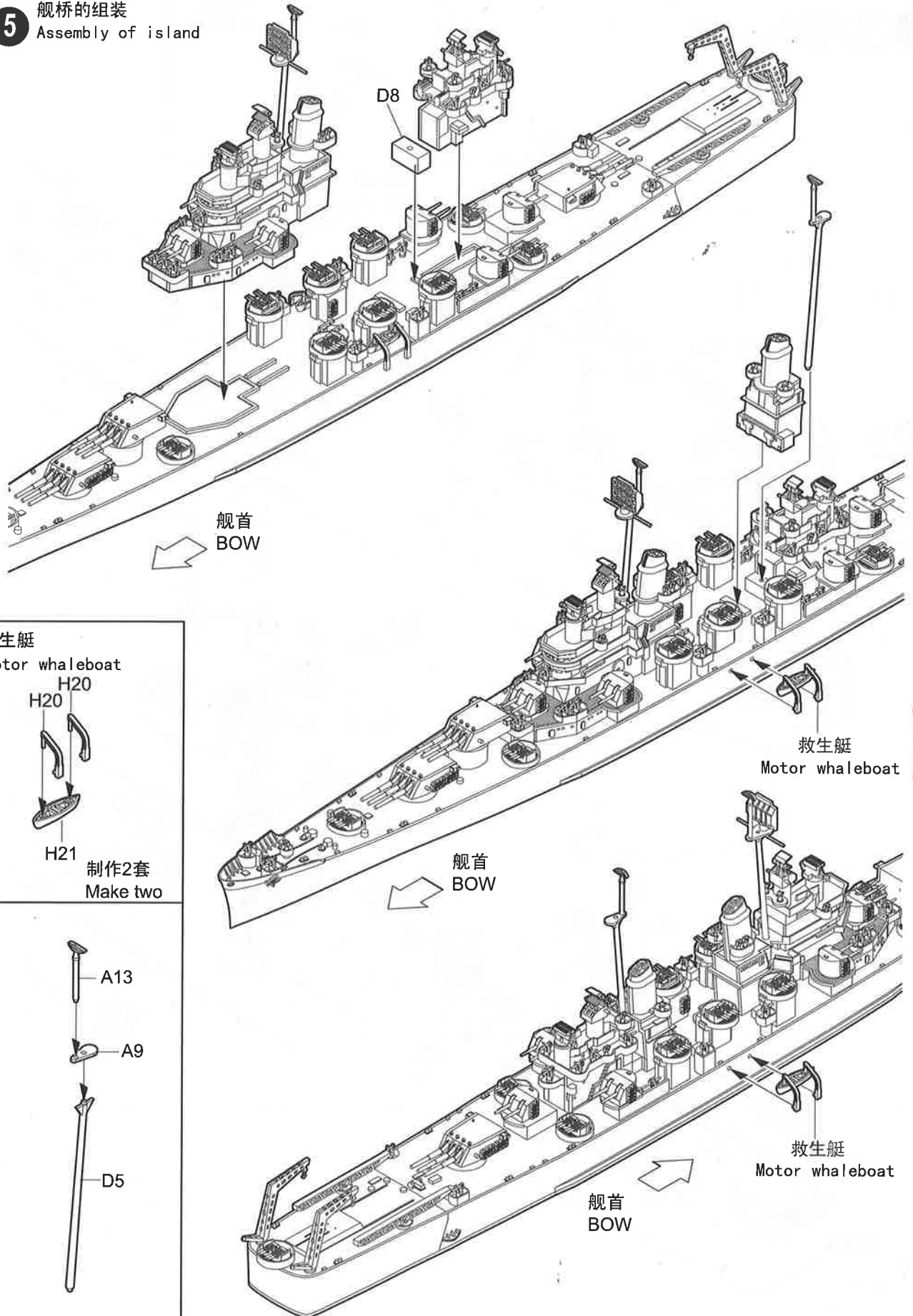

6 完成
Completion

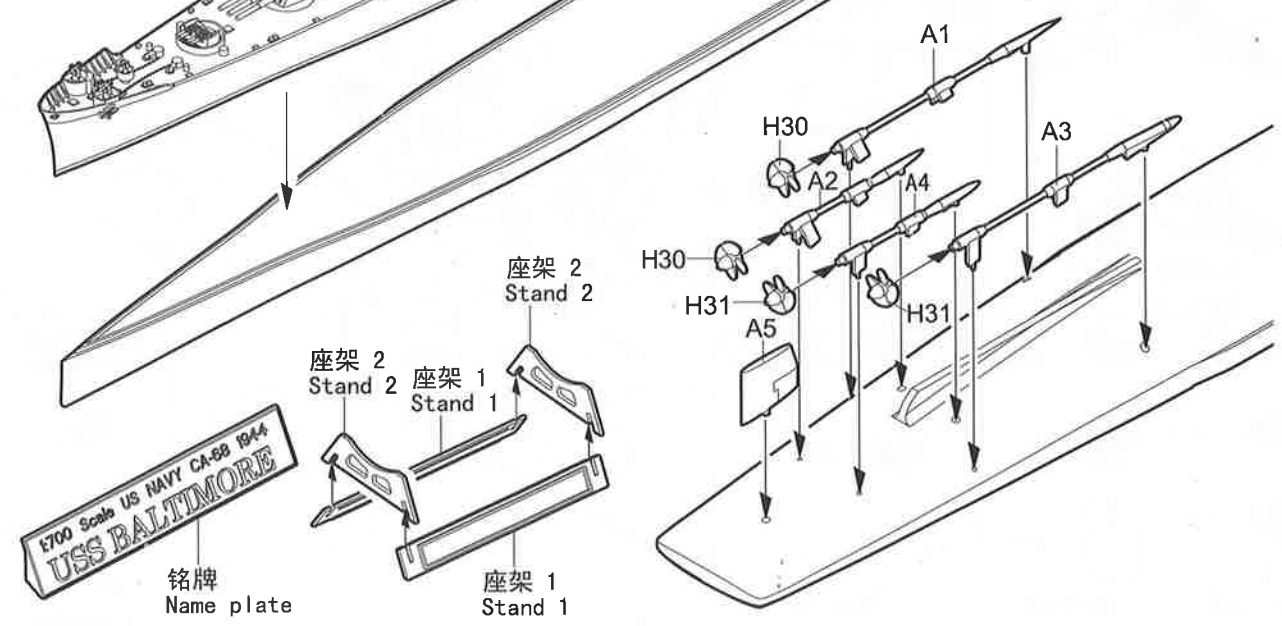
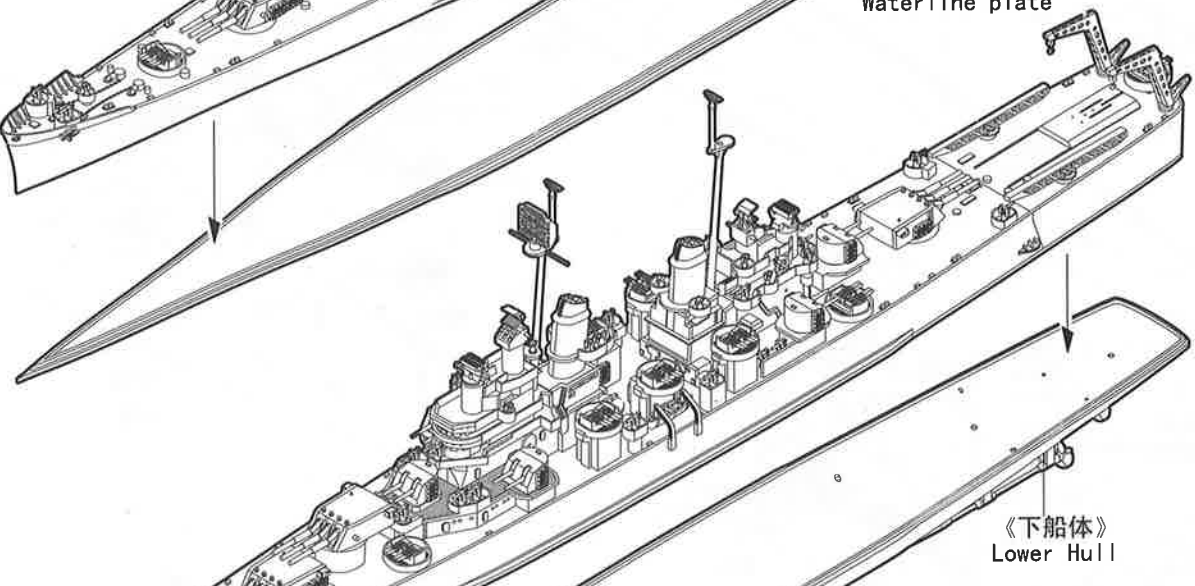
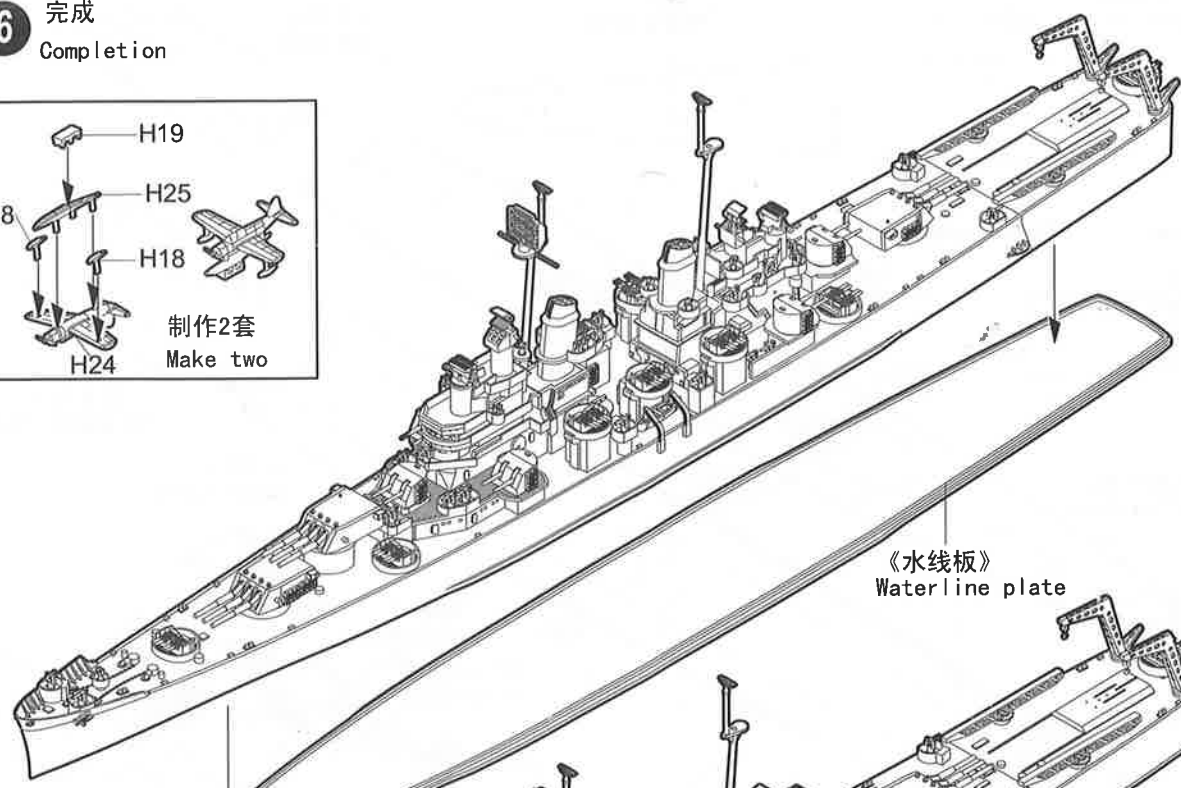
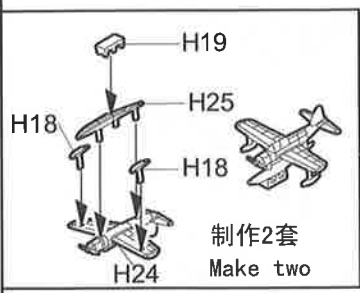

涂装同标贴指示 Painting & Marking guide

H 8 GUNZE SANGYO AQUEOUS HOBBY COLOUR

8 GUNZE SANGYO MR.COLOUR

Gunze		
H 9 9	金色	GOLD
H 53 13	雾灰	HAZE GRAY
H 54 14	海军蓝	NAVY BLUE
H 17 29	舰底红色	COCOA BROWN
H 12 33	消光黑	FLAT BLACK
H 11 62	白色	WHITE
H 42 72	蓝灰色	BLUE GRAY
H 365 365	甲板蓝色	DECK BLUE
H 338 338	浅灰色	LIGHT GREY

