



EstesRockets.com

GLEDA MAY™

0900

AGES
10+



Skill Level

INTERMEDIATE

MODEL ROCKET INSTRUCTIONS

KEEP FOR FUTURE REFERENCE

IMPORTANT: Please record date found on decal and keep for future reference. _____

READ ALL INSTRUCTIONS. Make sure you have all parts and supplies. Test fit all parts before applying glue. Refer to your glue manufacturer's dry times during build.

SUPPLIES



PENCIL



HOBBY KNIFE



FINE SANDPAPER

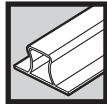

SANDING BLOCK



YELLOW GLUE



WAX PAPER



SCISSORS



CLEAR TAPE



WHITE PRIMER



WHITE & BLACK PAINT



PURPLE & GOLD PAINT

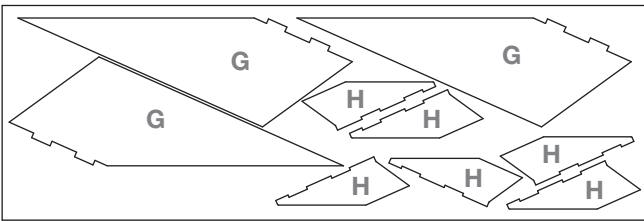

095001-0900
Laser cut wood sheet

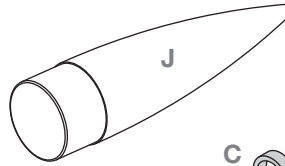

073004
Balsa nose cone

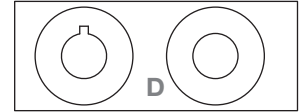

030128
Centering rings



038178
Launch lug



038251
Eye screw

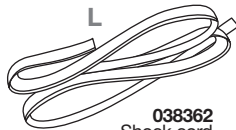

038362
Shock cord

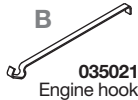

035021
Engine hook



030224
Engine block



030168
Mylar engine hook
retainer ring

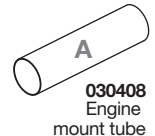

030408
Engine
mount tube



090001-0900
Waterslide decals

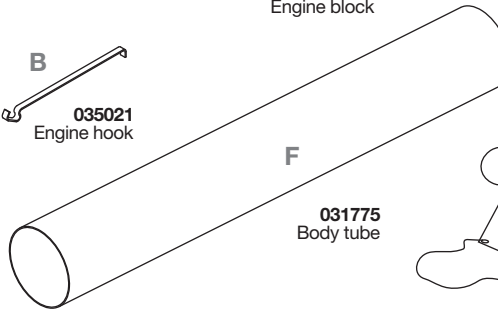

031775
Body tube

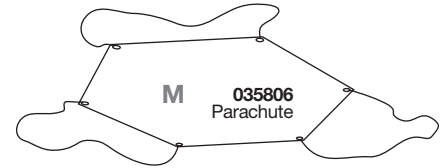

035806
Parachute

ASSEMBLE ENGINE MOUNT

- Using a pencil, make marks at 1/4 in., 1 in., and 2.25 in. from the end of engine mount tube A.

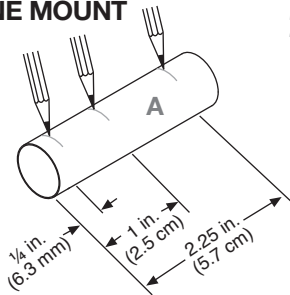

- Using a sharp hobby knife, make an 1/8 in. cut at the 2.25 in. pencil mark. Insert engine hook B into slot.

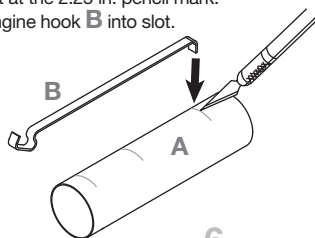

- Apply glue just forward of the 1 in. mark. Slide mylar engine hook retainer ring E over the end of engine mount tube A until the ring aligns with the 1 in. mark.

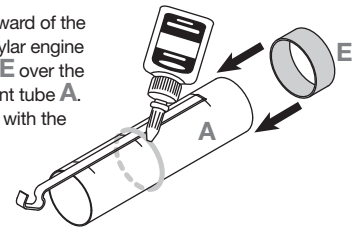

- Apply glue to the inside of engine mount tube A. Insert engine block C until it rests against the engine hook.

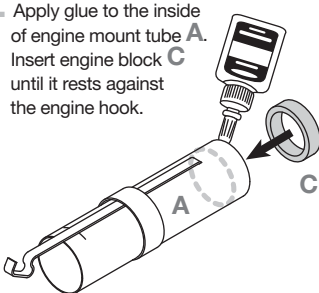

- Apply glue to the 1/4 in. mark of engine mount tube A and at the forward end of the engine mount tube.

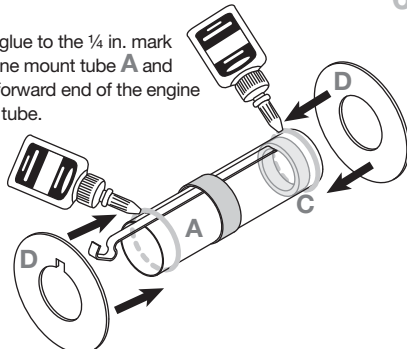

- Align centering ring D with the notch over the engine hook and align with the 1/4 in. mark. Place the other centering ring over the end of the engine mount tube.

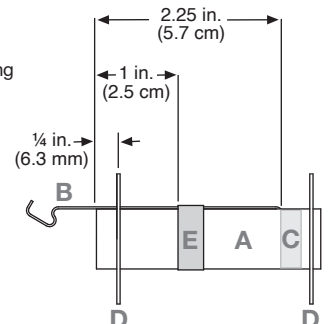
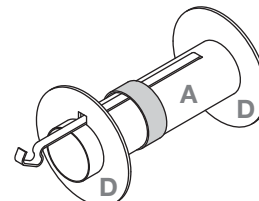

LET DRY

ASSEMBLE FINS

1. Sand both sides of the laser cut balsa wood. Using a hobby knife, cut out all **G** and **H** fin pieces.

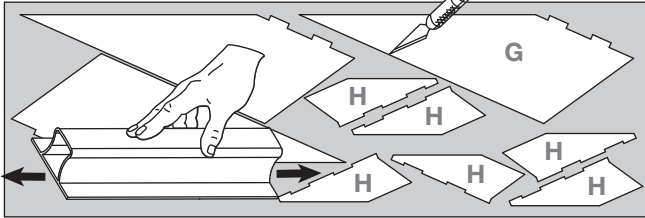

2. Apply glue to the inside edge of **H** fin pieces.

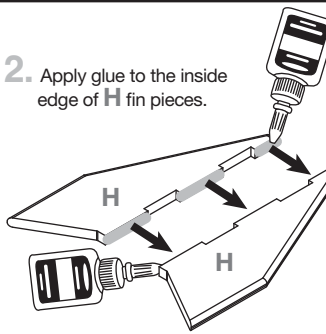

3.

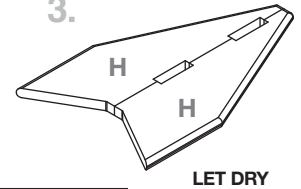

LET DRY

NOTE:

Glue together on wax paper on a flat surface.

4. Using fine sandpaper, round the leading edge of all **G** and **H** fin pieces.

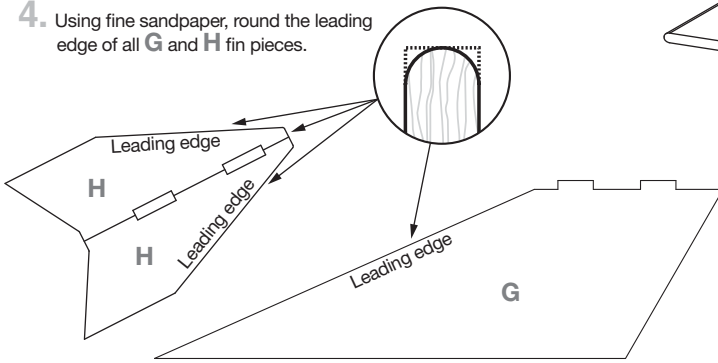

5. Apply glue to notches of **G** fin pieces. Align the notches with the cutouts on **H** fin pieces. The **G** and **H** pieces should join together at a 90° angle.

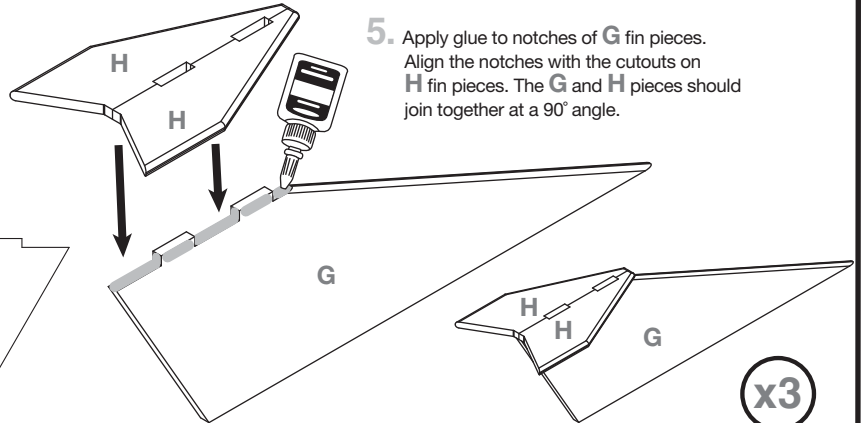

x3

LET DRY

TUBE MARKING

1. Cut out the tube marking guide from page 3. Wrap the guide around body tube **F**. Use a piece of tape to secure the guide around the body tube.

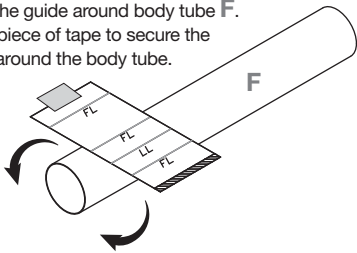

2. Using a pencil mark every line from the tube marking guide onto body tube **F**. Be sure to label the "fine lines" and "launch lug" line.

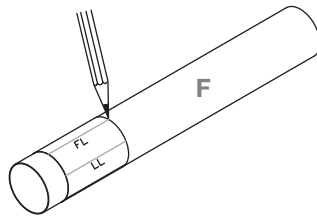

3. Use a door frame as a straight edge to extend all the lines on body tube **F**.

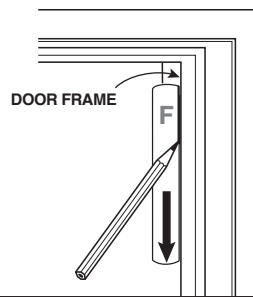

4.

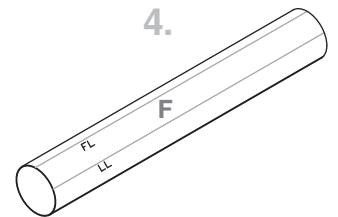

ATTACH FINS

1. Apply glue to the base of fin **G**. Align the fin with the "fin line" marking on the body tube.

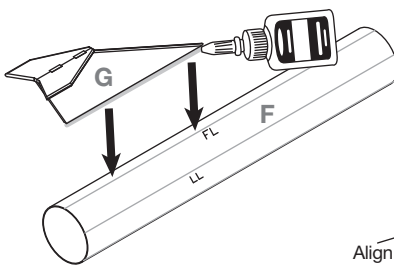

2. Make sure the base of the fin aligns with the bottom of the body tube.

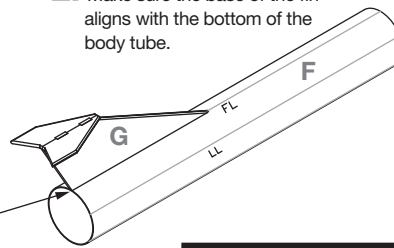

NOTE:

Use the fin alignment guide on page 3 to ensure the fins are at the correct angle.

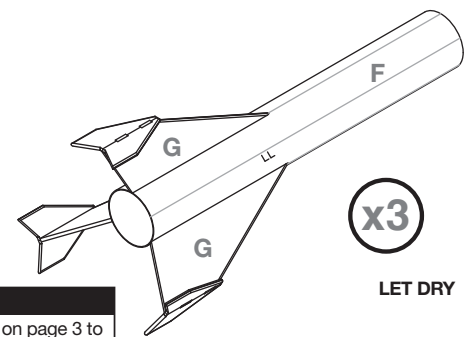

x3

LET DRY

INSTALL ENGINE MOUNT

1. Apply glue to the inside of body tube **F**. Insert engine mount assembly.

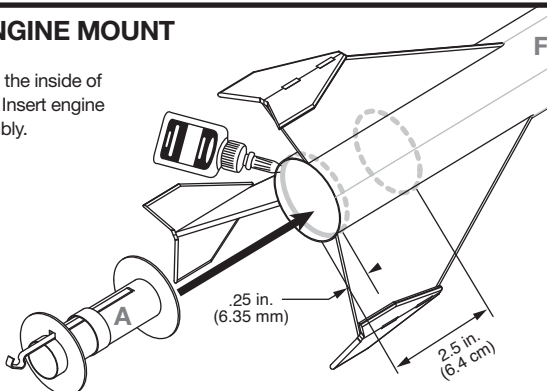

2. Make sure the end of engine mount tube **A** aligns with the end of body tube **F**.

ENDS EVEN

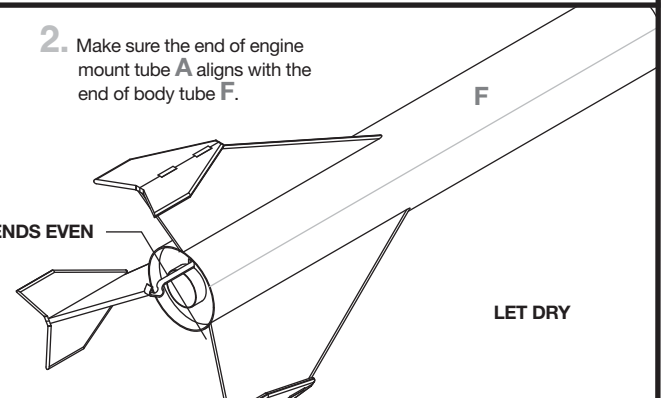

LET DRY

TEMPLATES

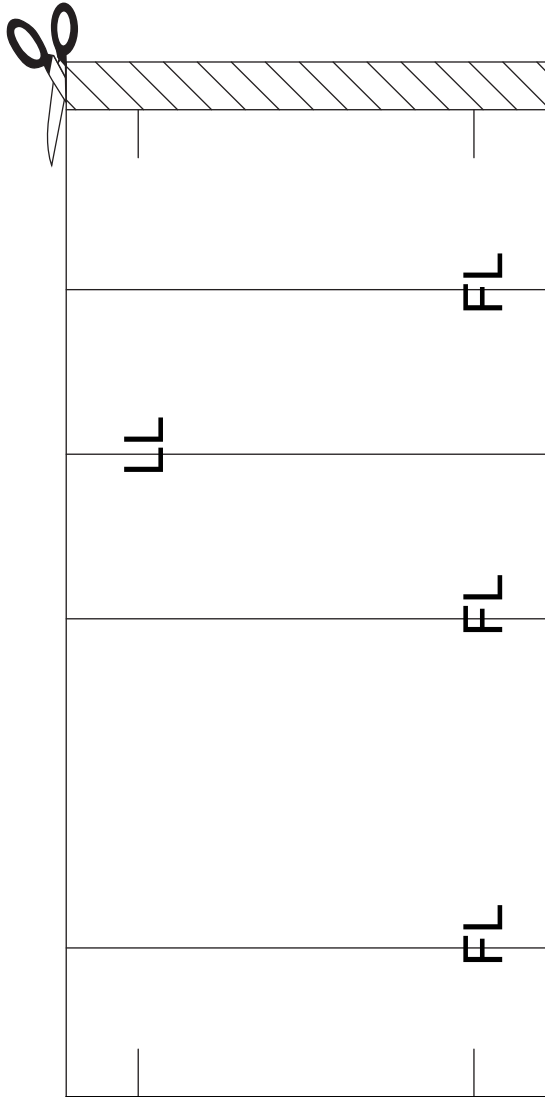

FIN MARKING GUIDE

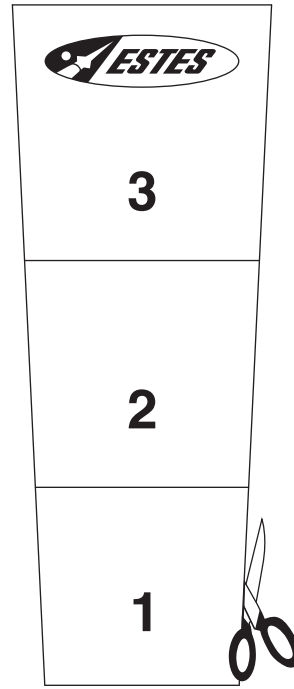

SHOCK CORD MOUNT

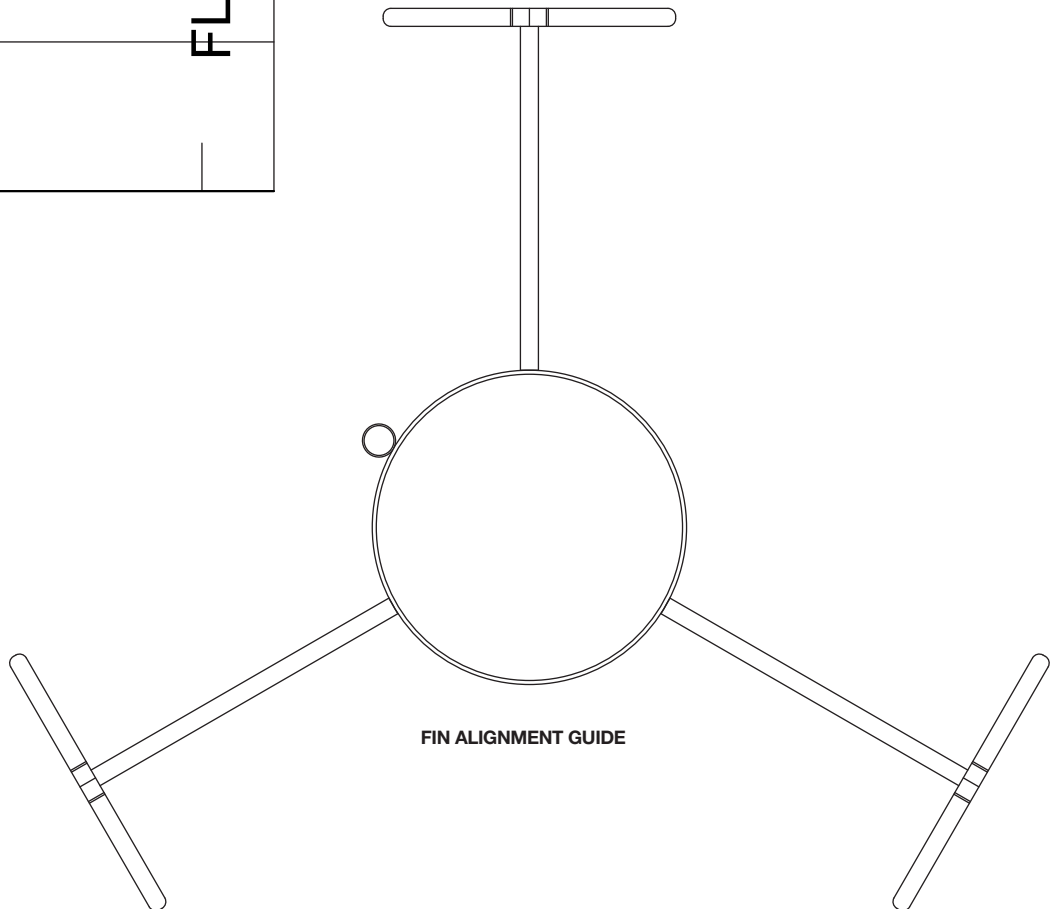

FIN ALIGNMENT GUIDE

**THIS PAGE
INTENTIONALLY
LEFT BLANK**

ATTACH LAUNCH LUGS

1. Mark line LL with pencil.

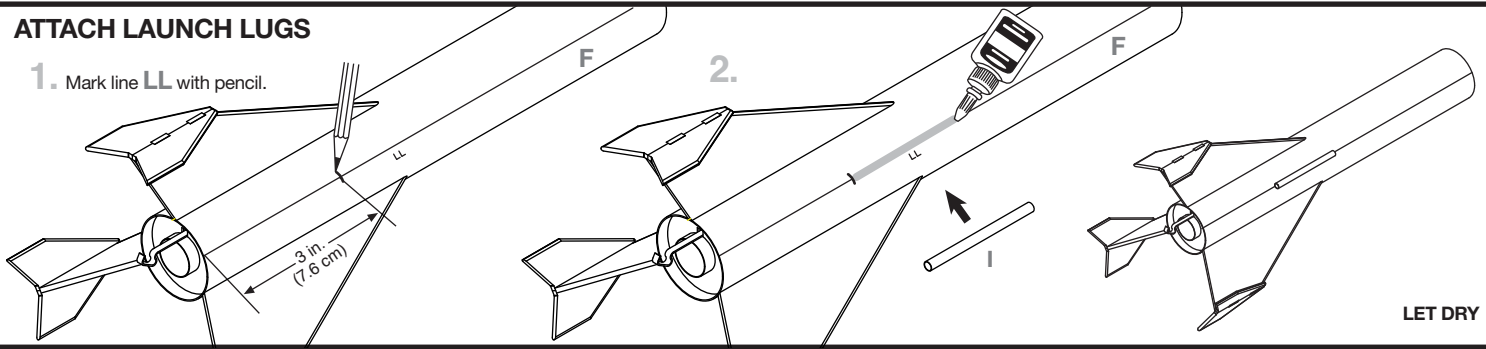

LET DRY

PREPARE NOSE CONE

1. Screw K into base of J.

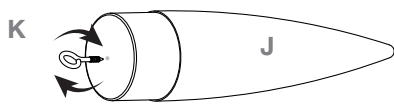

2. Remove K and apply glue in hole, then screw K back into place.

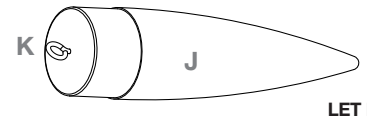
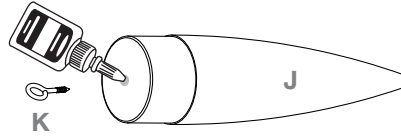

LET DRY

ATTACH SHOCK CORD

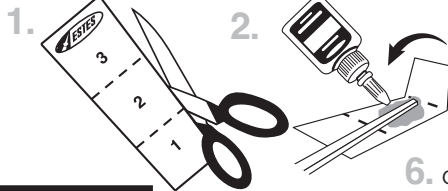

NOTE:
Cut from page 3.

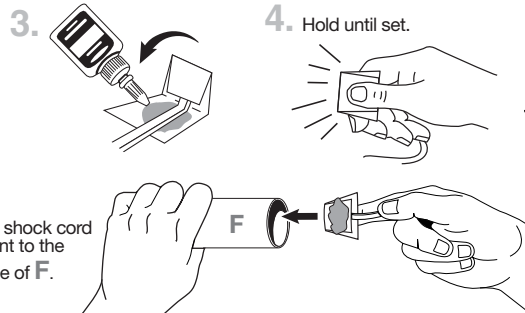

5. Apply glue to shock cord mount.

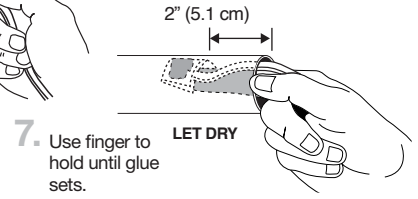

LET DRY

ASSEMBLE RECOVERY SYSTEM

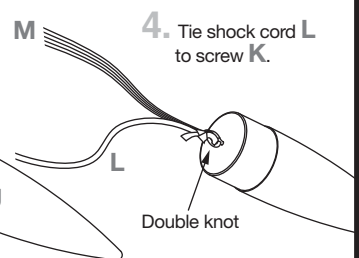
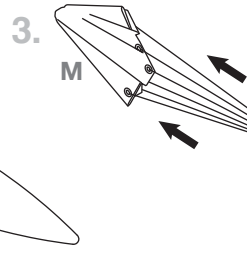
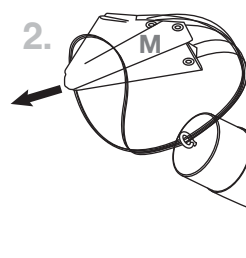
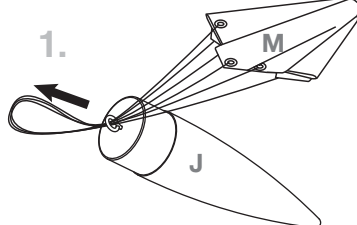

Double knot

PREPARE PARACHUTE

1. Push recovery wadding down towards end of body tube.

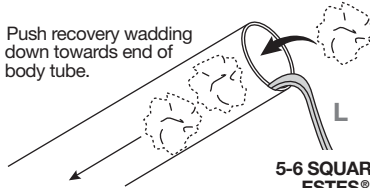

5-6 SQUARES
ESTES®
RECOVERY WADDING

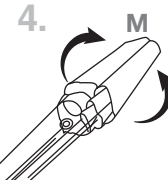
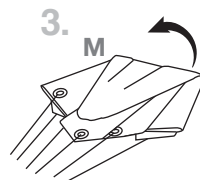
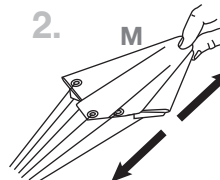

5. Wrap shroud lines loosely and insert parachute into body tube.

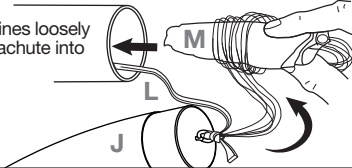

6. Insert nose cone into body tube.

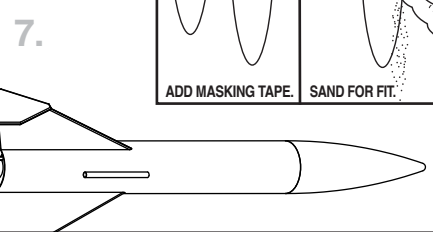
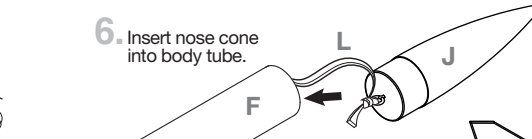

NOTE:
Recovery wadding and parachute must slide easily into body tube. If too tight, redo.



ROCKET FINISHING

1. Spray rocket with white primer, let dry, and sand. Repeat until rocket is smooth, then paint entire rocket white. Apply decals only after paint is dry.
2. Cut decals from sheet, trimming close to edge.
3. One at a time, place in warm water until decal curls and begins to relax.
4. Remove and position on rocket, sliding decal away from backing material.
5. Blot with clean paper towel. Let set overnight.
6. OPTIONAL: Apply protective clear coat.

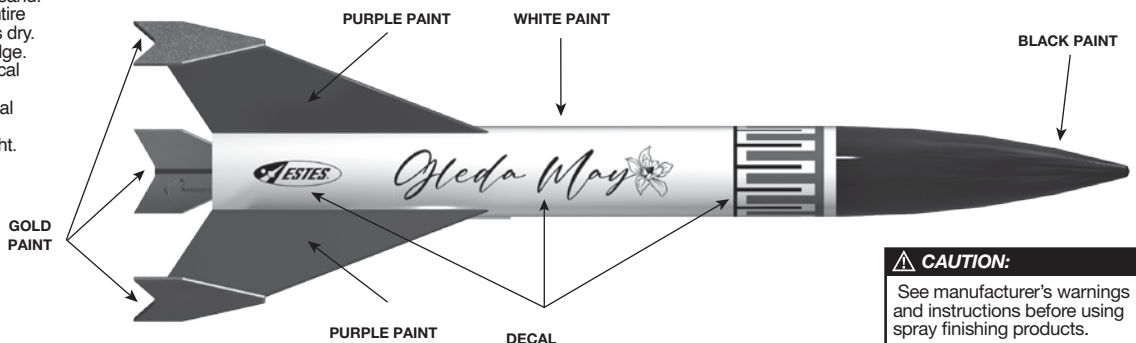

NOTE:
Please refer to packaging for suggested paint scheme and/or decal placement.

CAUTION:
See manufacturer's warnings and instructions before using spray finishing products.

PREPARE ENGINE

1. Use one each.

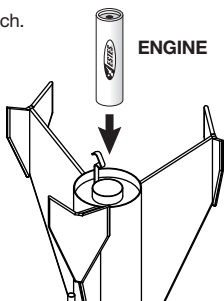

2.

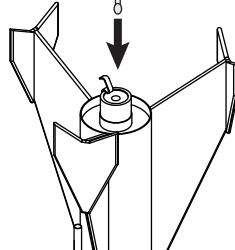

TIP MUST TOUCH PROPELLANT!

3.

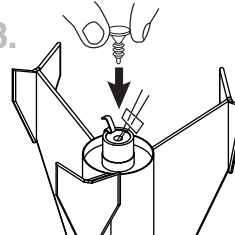

4.

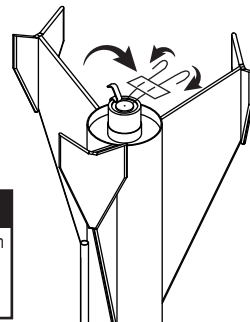

⚠ WARNING: FLAMMABLE

To avoid serious injury, read instructions & NAR Safety Code included with engines. **PREPARE YOUR ENGINE ONLY WHEN YOU ARE OUTSIDE AT THE LAUNCH SITE PREPARING TO LAUNCH.** If you do not use your prepared engine, remove the starter before storing your engine.

NOTE:

Always keep the key **OUT** until final countdown.



2.



3.



4.

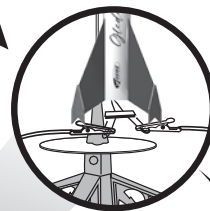

5. Fully extend your launch controller wire before launching.

16.4 ft. (5 m)



1.

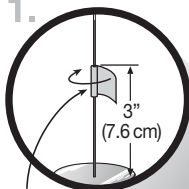

MASKING TAPE

KEY

6.

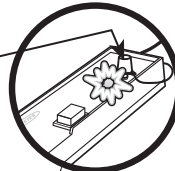

Insert key, push down hard. Bulb will light.

NOTE:

Estimated weight: 2.5 oz. (70.9 g)

ESTES® LAUNCH SUPPLIES NEEDED (Sold Separately)

- Porta-Pad® II Launch Pad
- Electron Beam® Launch Controller
- Recovery Wadding
- Starters (with engines)
- Plugs (with engines)
- Estes® Engines: B4-4, B6-4, C6-5

10.

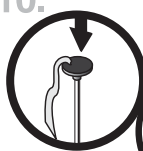

9.

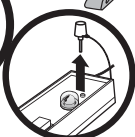

8.

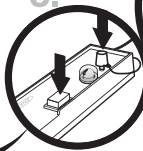

7.



4... 3... 2... 1...

While holding key down **FIRMLY**, press launch button until **LIFTOFF!**

PRECAUTIONS



NAR SAFETY CODE



NO DRY GRASS OR WEEDS

PRE-LAUNCH CHECK For safety, never launch a damaged rocket. Check the rocket's body, nose cone and fins. Also, check the engine mount, recovery system and launch lug(s). Repair any damage before launching the rocket.

FLYING YOUR ROCKET Choose a large field (1000 ft. [305 m] square) free of dry weeds and brown grass. The larger the launch area, the better your chance of recovering your rocket. Launch only with little or no wind and good visibility. Always follow the National Association of Rocketry (NAR) SAFETY CODE (enclosed).

MISFIRES TAKE THE KEY OUT OF THE CONTROLLER. WAIT ONE MINUTE BEFORE GOING NEAR THE ROCKET. Disconnect the micro-clips and remove the engine. Take the plug and starter out of the engine. A burned starter means the starter tip was not touching engine propellant. Install a new starter; be sure the tip is touching propellant inside the engine. Push the plug in place. Repeat steps under Countdown and Launch.

